

## SPECIFICATION

Model No. : **AA.161**

Part No. : **AA.161.301111**

Product Name : Magnet Mounted GPS-GLONASS Antenna

Feature : 1575MHz – 1610MHz  
1.8-5.5V  
3m RG174 SMA(M)  
IP67 Rated  
Custom cables and connectors available  
RoHS ✓



## 1. Introduction

This antenna is designed for applications which require high positioning accuracy by combining signals from GPS and GLONASS systems. High gain wide-band patch antenna on a large integral ground delivers maximum performance.

## 2. Specification

ELECTRICAL			
Centre Frequency	1574~1610MHz		
Antenna Gain	26 ± 3dBic @ zenith @ 1575.42MHz 27 ± 3dBic @ zenith @ 1602MHz		
Axial Ratio	3.0dB max. @ zenith @ center frequency		
Polarization	RHCP		
VSWR	2.0 max.		
Impedance	50Ω		
DC input	1.8V (min.)	3.0V (typ.)	5.5V (max.)
LNA Gain	22dB	28dB	31dB
Noise Figure	2.6dB	2.6dB	2.6dB
Power Consumption	5mA	10mA	23mA
MECHANICAL			
Antenna Dimensions	65.7 x 49.7 mm		
Housing Material	ABS		
Cable	3m RG174 (fully customizable)		
Connector	SMA(M) (fully customizable)		
ENVIRONMENTAL			
Operation Temperature	-40°C to 85°C		
Storage Temperature	-40°C to 105°C		
Relative Humidity	40% to 95%		

### 3. Antenna Block Diagram

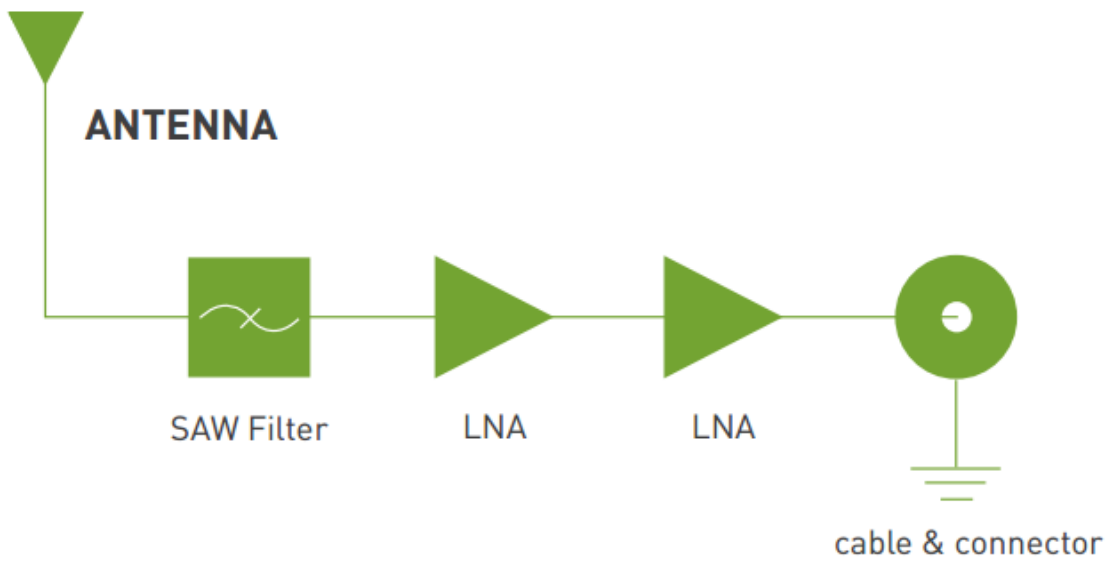

## 4. Antenna S11 Property

### 4.1 Return Loss

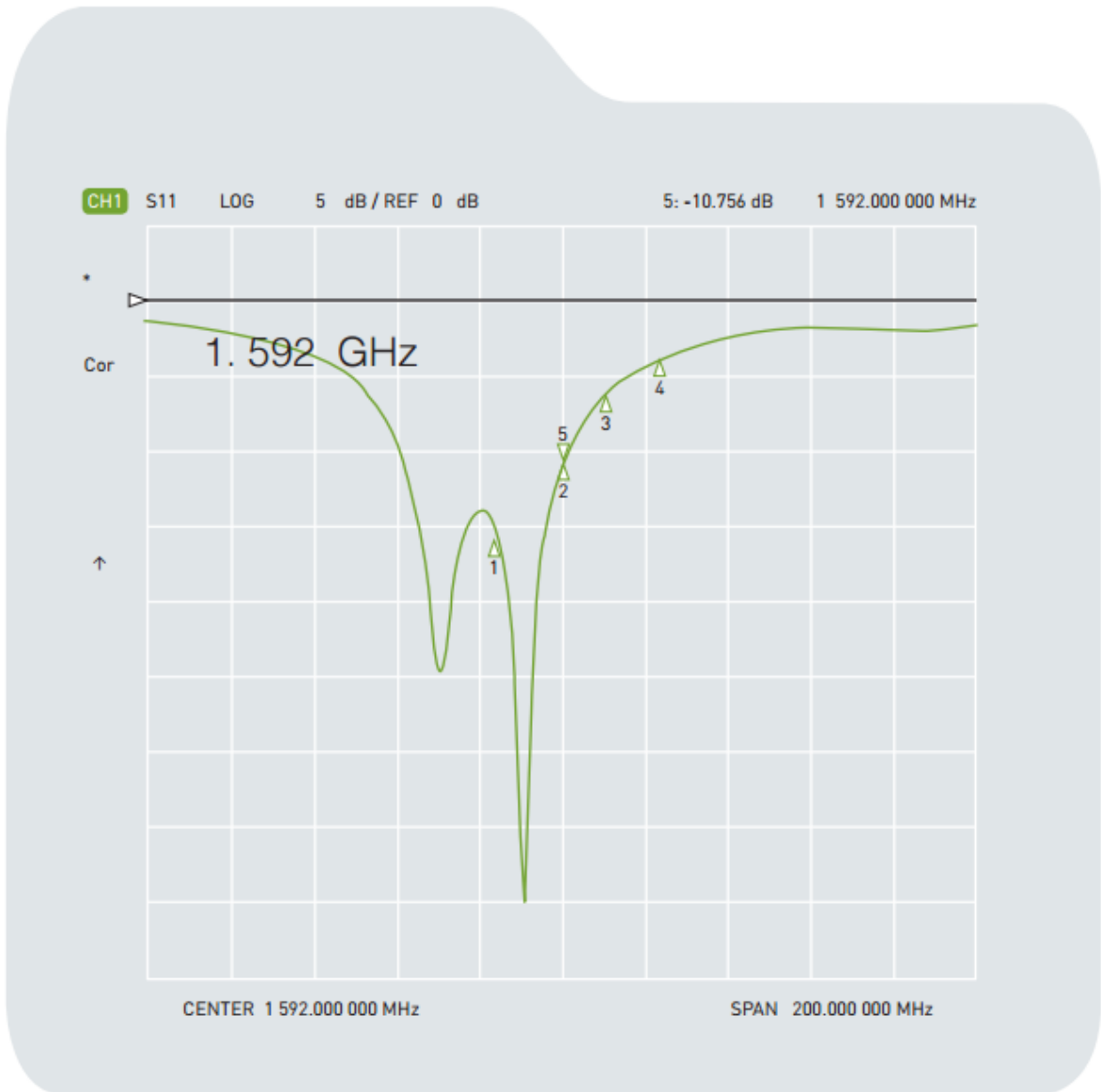

## 4.2 Impedance

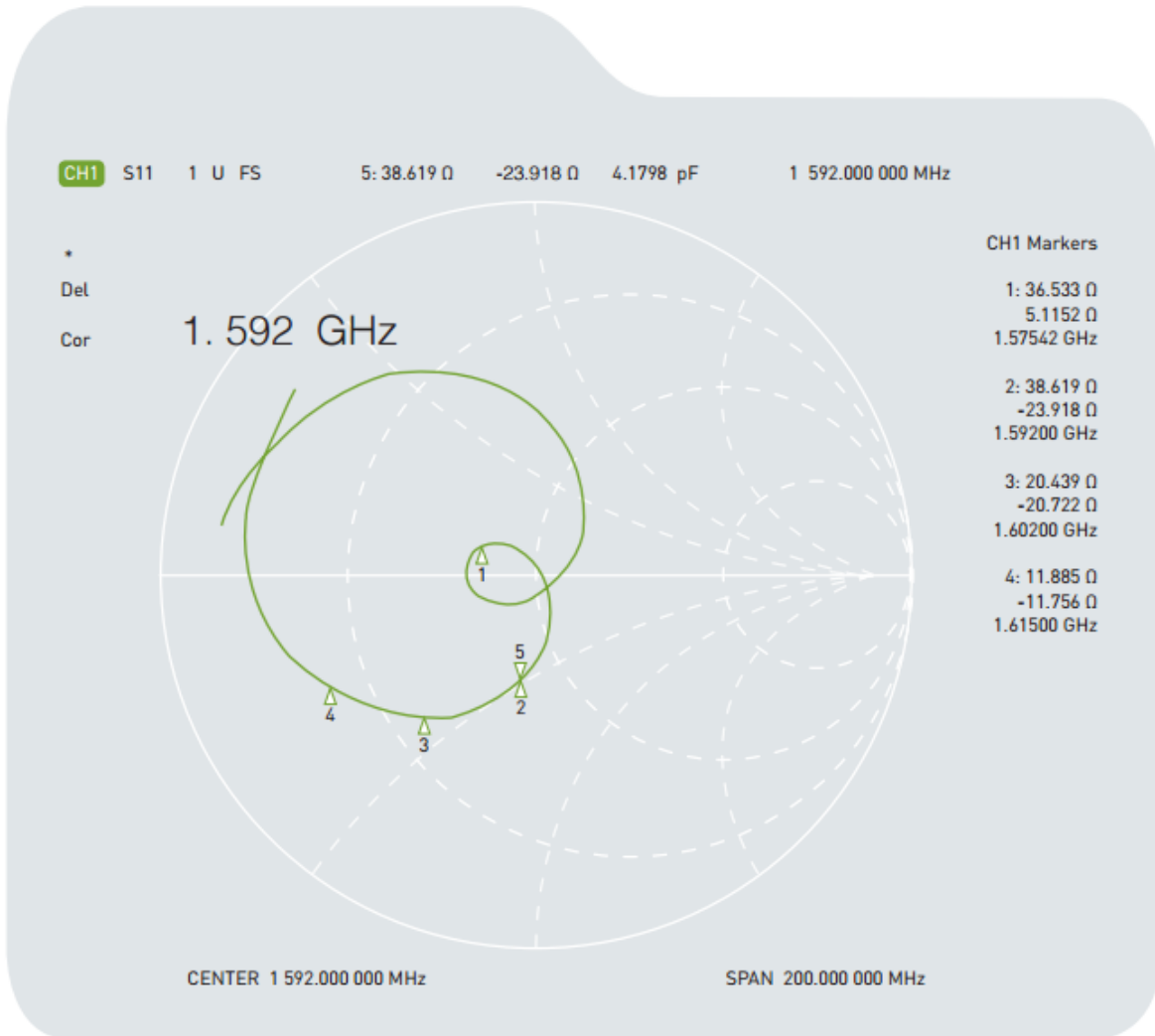

Test Frequency	Return Loss (dB)	Impedance (Ω)	VSWR
1575MHz	-15.8	35.6 + j5.1	1.4
1602MHz	-6.2	20.4 - j20.7	2.9

## 5. Radiation Patterns

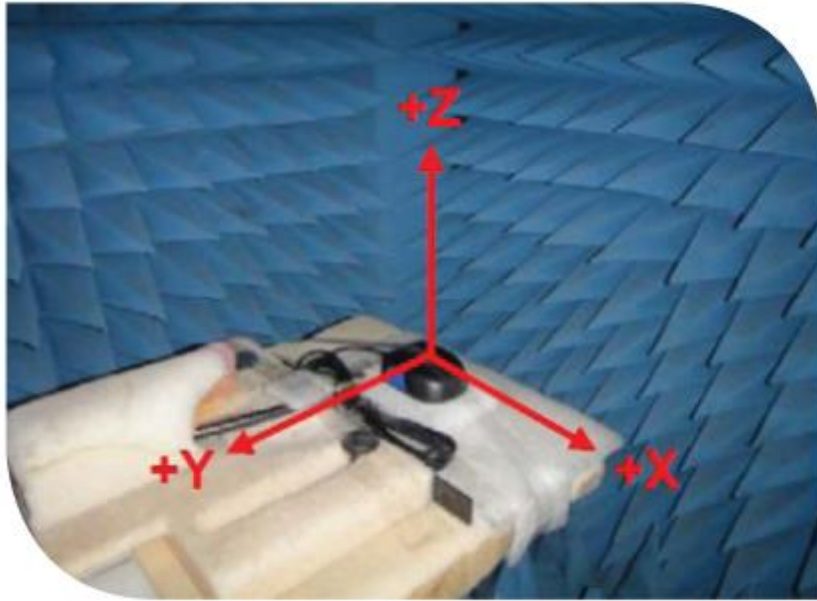

1575.42MHz

XZ Plane

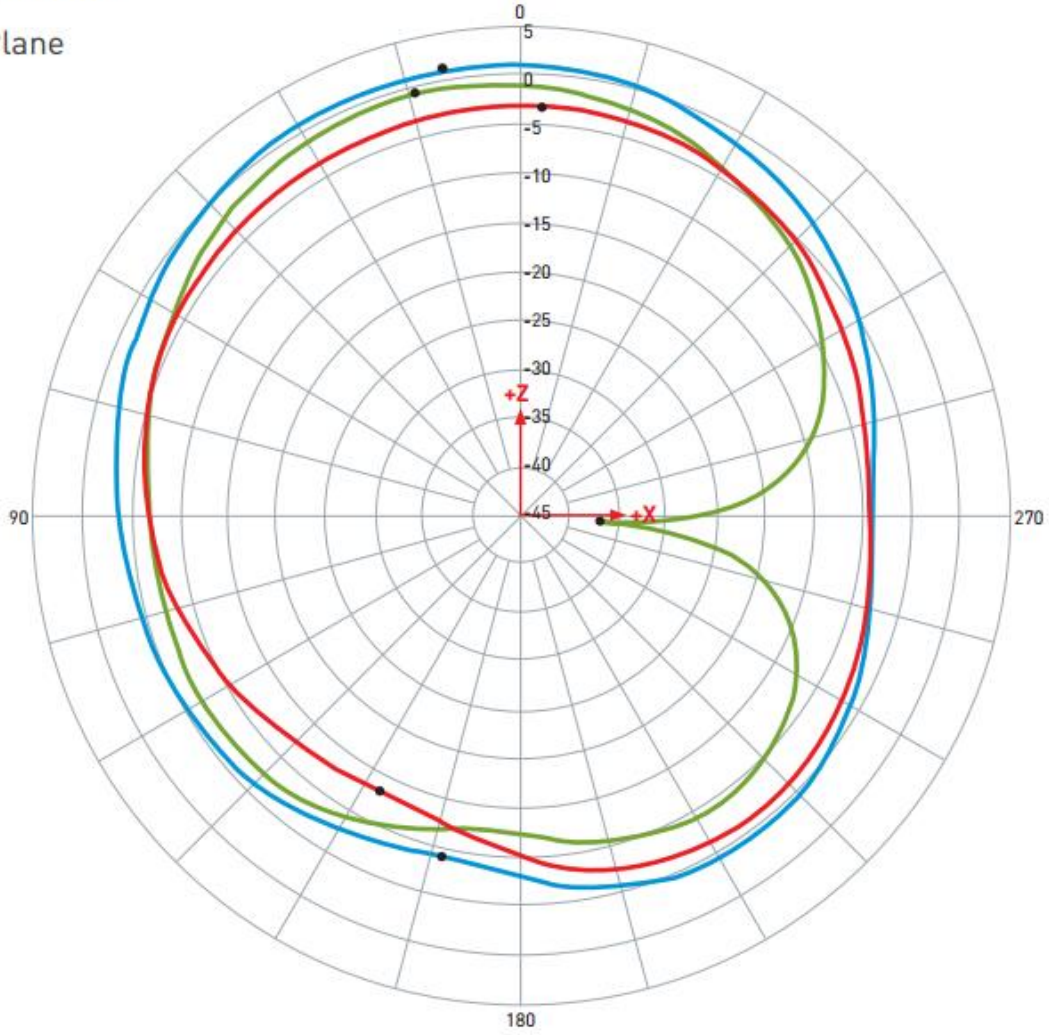

	Peak Gain	Zenith Gain
Horizontal	-3.0	-3.1
Vertical	-0.6	-0.9
Total	1.3	1.1

(unit : dBi)

**1575.42MHz**

YZ Plane

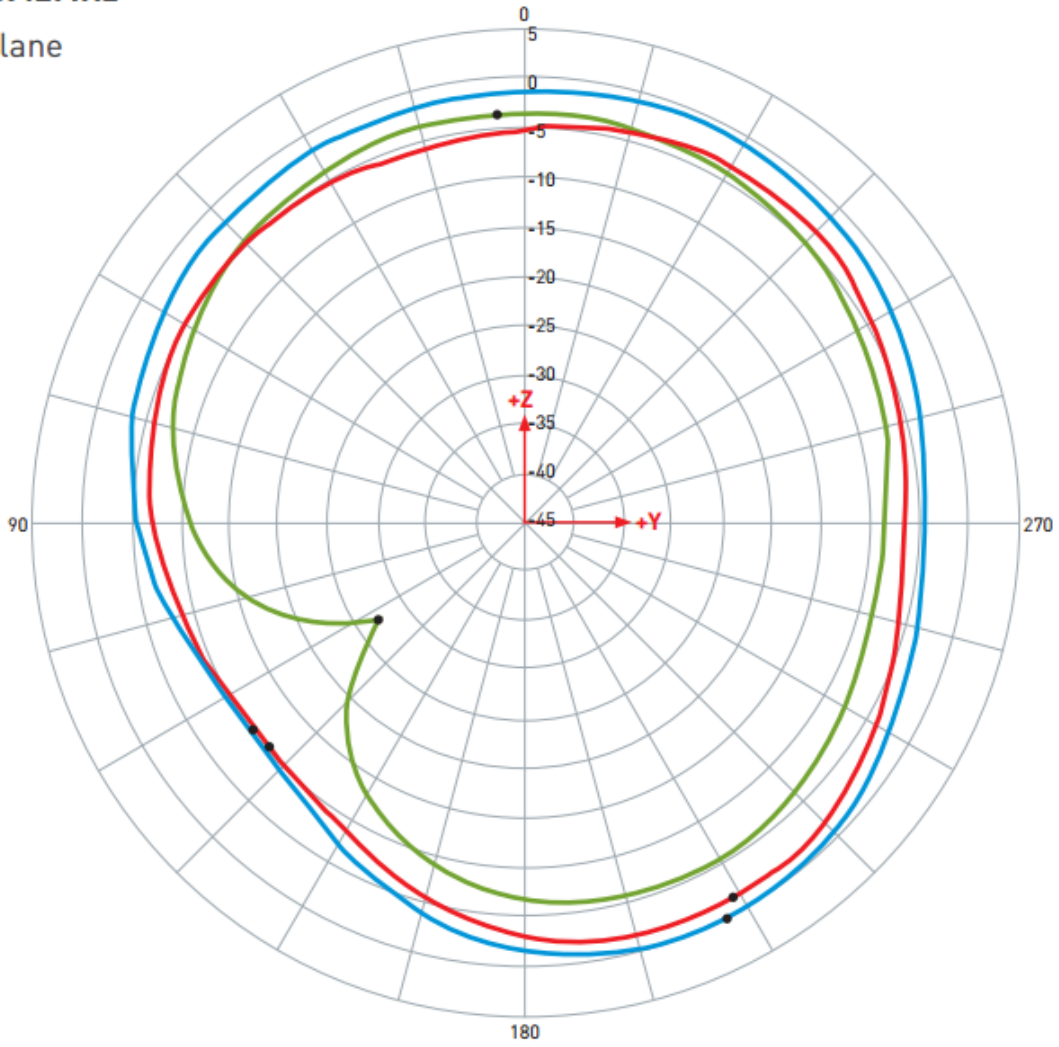

	Peak Gain	Zenith Gain
Horizontal	-1.7	-5.2
Vertical	-3.5	-3.5
Total	-0.3	-1.3

(unit : dBi)



**1602MHz**  
XZ Plane

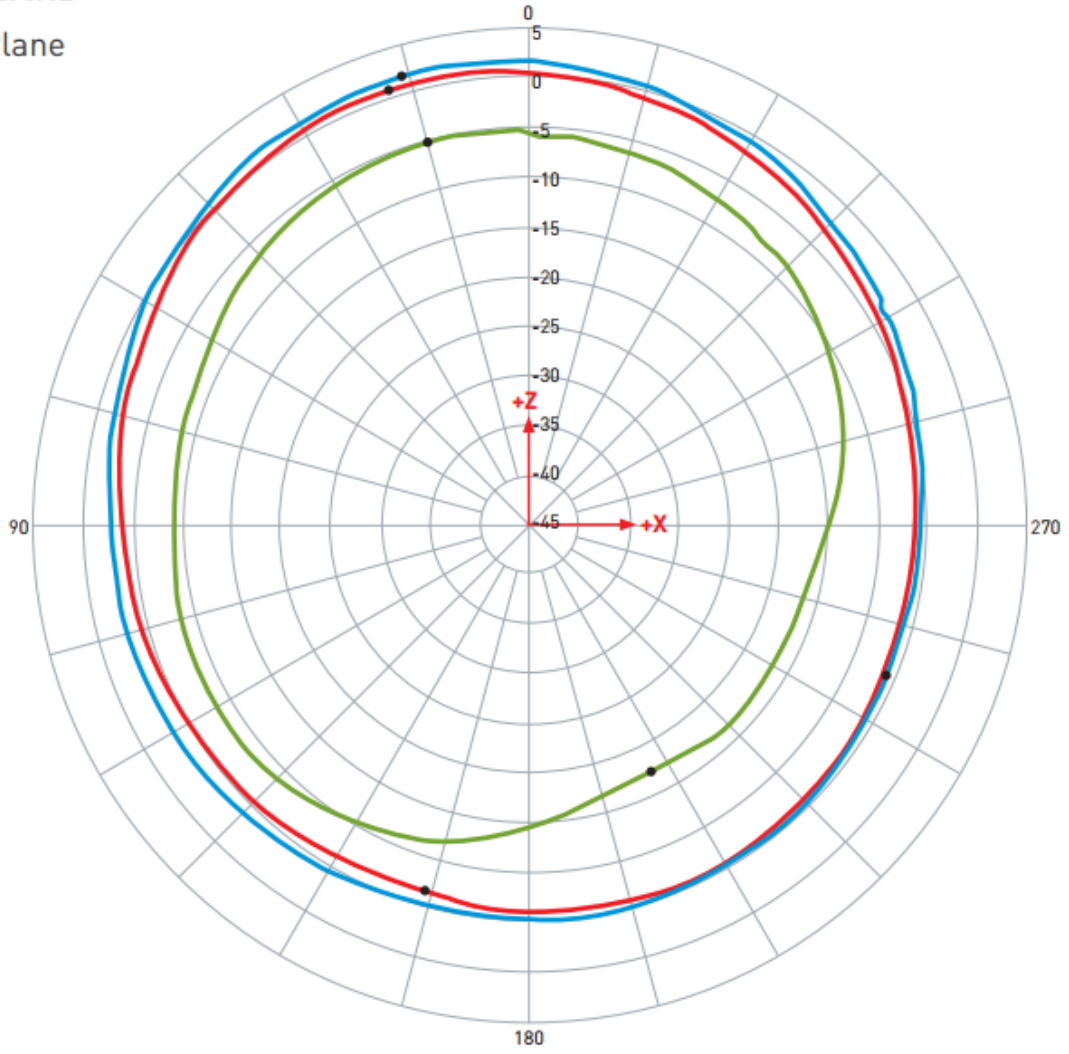

	Peak Gain	Zenith Gain
Horizontal	0.8	0.6
Vertical	-5.2	-5.4
Total	1.8	1.6

(unit : dBi)

**1602MHz**  
YZ Plane

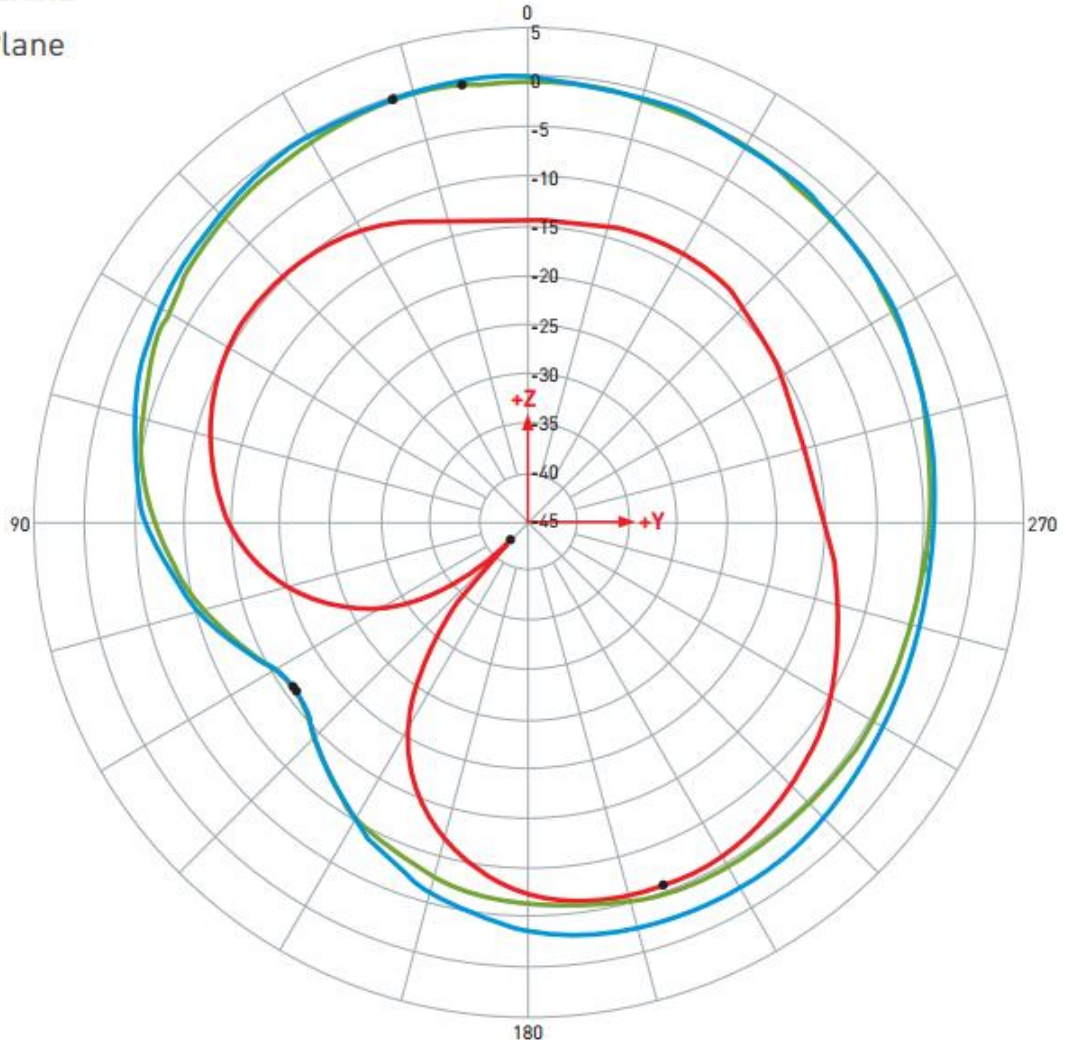

	Peak Gain	Zenith Gain
Horizontal	-5.8	-14.7
Vertical	-0.4	-0.4
Total	-0.2	-0.3

(unit : dBi)

## 6. LNA Gain and Out Band Rejection @3.0V



Ch1	Tr1	S21	1	1.5740000 GHz	28.186 dB
Ch1	Tr1	S21	>2	1.6100000 GHz	27.949 dB
Ch1	Tr1	S21	3	1.5920000 GHz	29.044 dB
Ch1	Tr1	S21	4	1.5420000 GHz	9.0245 dB
Ch1	Tr1	S21	5	1.6420000 GHz	-10.035 dB
Ch1	Tr1	S21	6	1.4920000 GHz	4.4105 dB
Ch1	Tr1	S21	7	1.6920000 GHz	-14.431 dB

## 7. LNA Noise Figure @3.0V

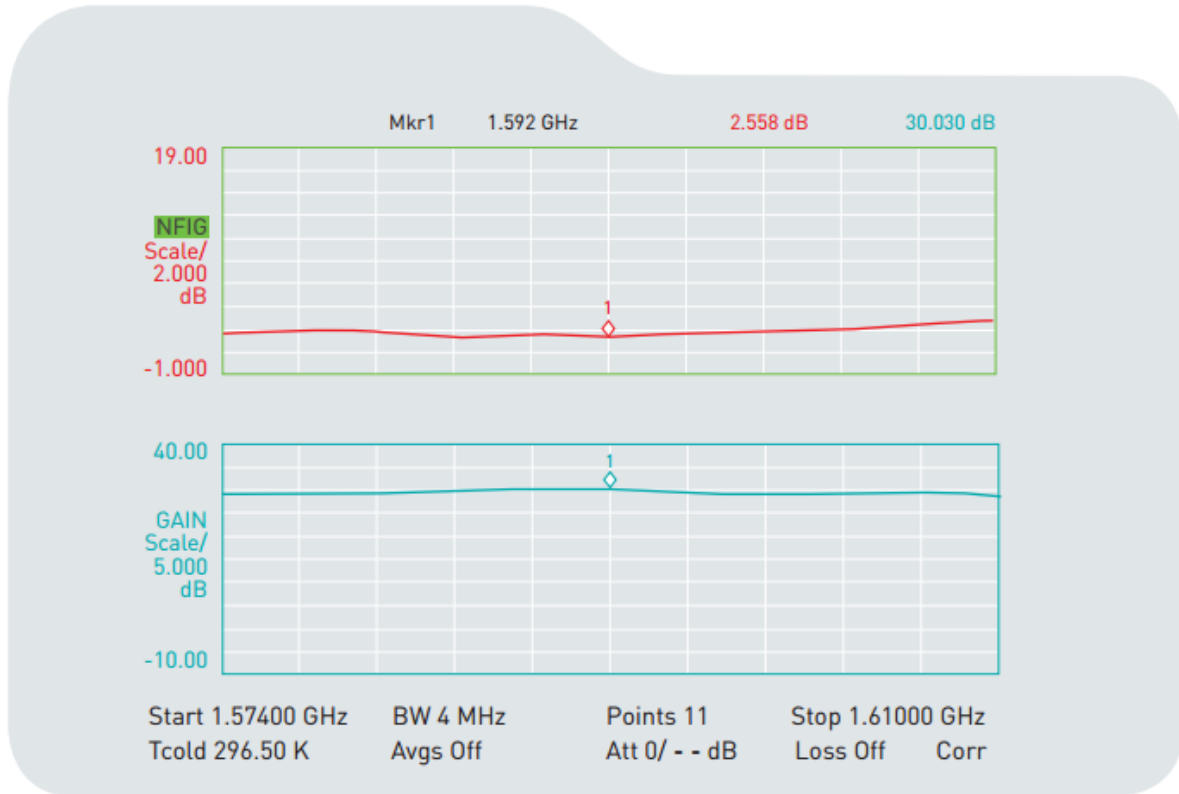

## 8. Axial Ratio

### 1575.42MHz Axial Ratio

1575.42MHz Axial Ratio

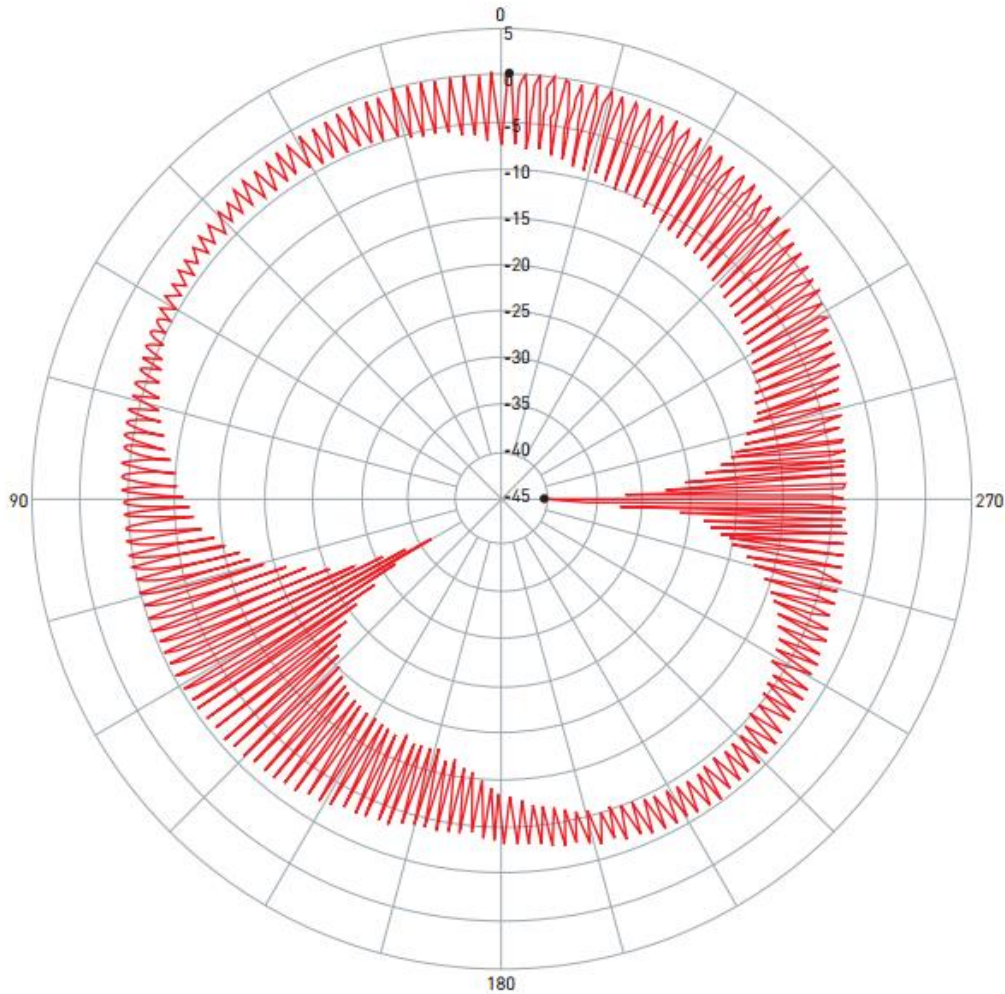

Pattern	Model No.	Test Mode	Freq (MHz)	Max Gain(dBi)	Min Gain(dBi)	Avg. Gain(dBi)	Source Polar.
1	AA.161.301111	Axial Ratio	1575.42	0.21 / 359.30	-40.73 / 263.95	-5.89	CP

Angle	90°	75°	60°	45°	30°	15°	0°	345°	330°	315°	300°	285°	270°
Axial Ratio	6.97	3.06	1.27	1.89	3.62	5.30	7.10	9.03	9.61	9.56	9.11	10.55	31.83

1602MHz XZ Plane

1602MHz XZ Plane

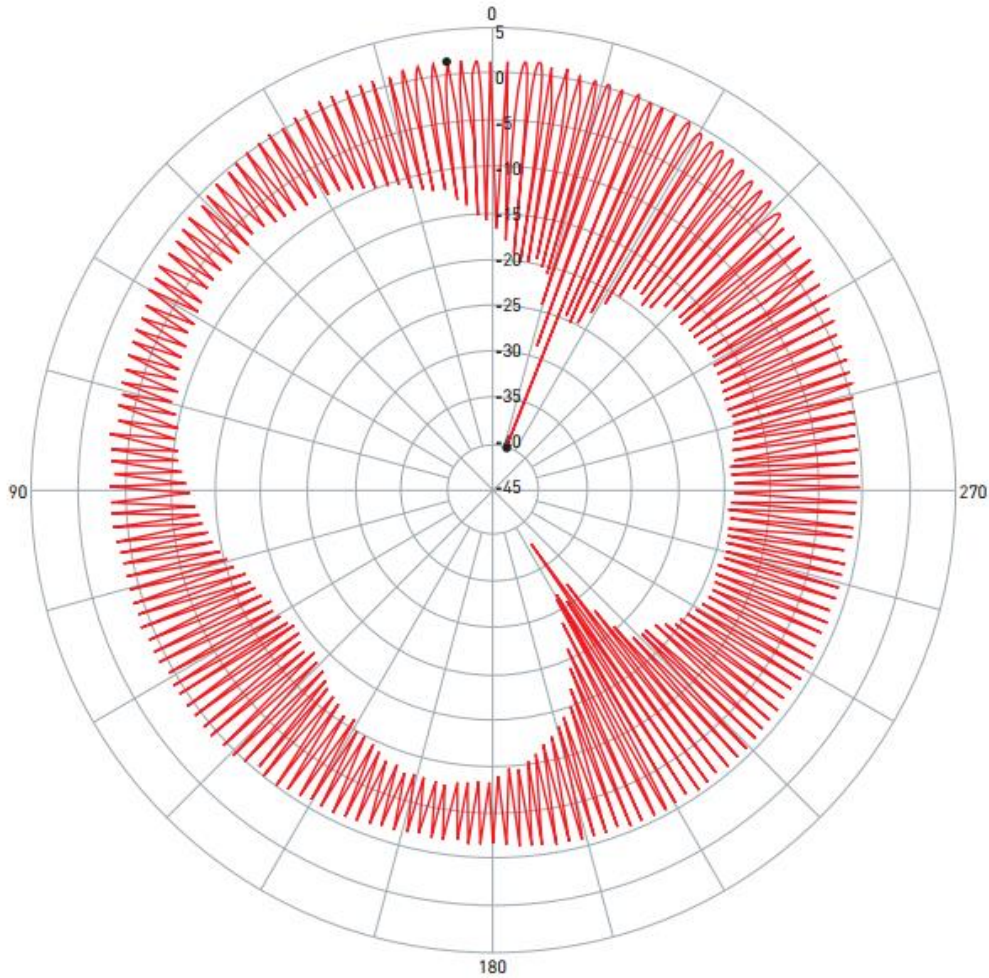

Pattern	Model No.	Test Mode	Freq (MHz)	Max Gain(dBi)	Min Gain(dBi)	Avg. Gain(dBi)	Source Polar.
1	AA.161.301111	Axial Ratio	1602.00	1.63 / 6.32	-40.19 / 341.15	-5.20	CP

Angle	90°	75°	60°	45°	30°	15°	0°	345°	330°	315°	300°	285°	270°
Axial Ratio	8.46	6.32	5.84	6.97	9.11	12.43	17.25	25.33	22.57	15.29	14.09	13.39	13.23

# 9. Drawing

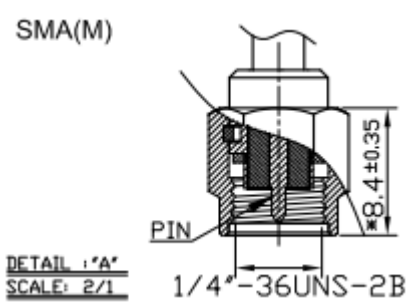
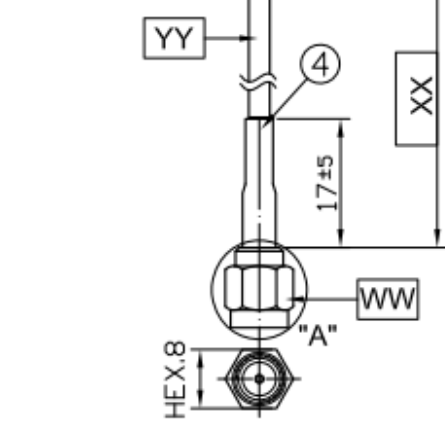
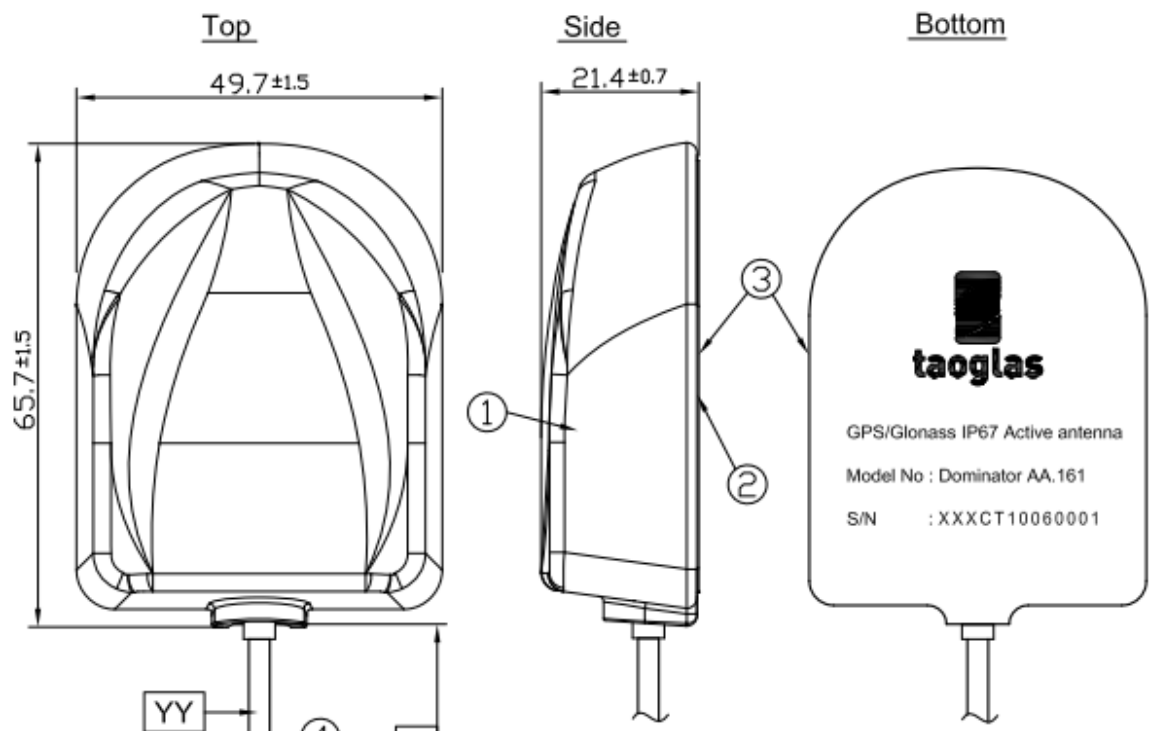

DETAIL: 1\" data-bbox="105 830 185 855"/>

	Name	Material	Finish	QTY
1	AA.161 Antenna Housing Top	ABS	Black	1
2	AA.161 Antenna Housing Bottom	ABS	Black	1
3	AA.161 Sticker	Matte Silver PEF	Silver	1
4	Heat Shrink Tube	PE	Black	1

	Name	Spec	Finish	QTY
WW	Connector Type	SMA(M)	Gold	1
XX	Cable Length	3000±30mm		1
YY	Cable Type	RG174	Black	1

# 10. Packaging

