

THIS DOCUMENT IS THE PROPERTY OF
KEYSTONE ELECTRONICS CORP. AND
SHALL NOT BE REPRODUCED, DISTRIBUTED
OR USED AS A BASIS FOR MANUFACTURE
WITHOUT PRIOR WRITTEN PERMISSION
FROM KEYSTONE ELECTRONICS CORP.

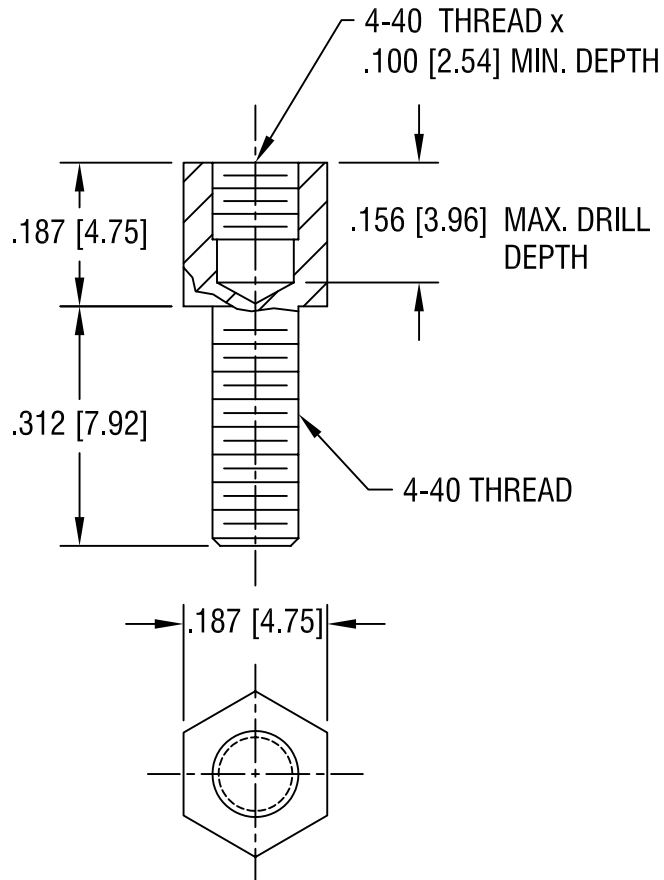

KEYSTONE ELECTRONICS CORP.

ASTORIA, N.Y. 11105-2017

PART NAME

JACK SCREW

MATERIAL

STEEL

FINISH

ZINC PLATE
CLEAR CHROMATE

DRN BY

BOONE

DATE

3.7.94

APP'D

LN

SCALE

4X

TOLERANCES

INCH [MM]

CODE

DWG NO.

DECIMAL $\pm .005$ [± 0.15]

C/M

ANGULAR $\pm 1^\circ$
UNLESS OTHERWISE SPECIFIED

7230-5

DATE

DESCRIPTION

REV.