

# G4W

PCB Power Relay

## Impulse Withstand Voltage as High as 10kV with 4kV Dielectric Strength: Ideal for Power Supply Switching

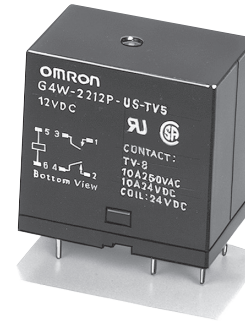

- Input and output (between coil and contacts) are completely separated, with impulse withstand voltage of 10,000 V.
- Insulation distance of 8 mm min. between coil and contacts satisfies the VDE Standard C/250 insulation requirements, and conforms to Electrical Appliance and Material Safety Law with dielectric strength of 4,000 VAC min. Standard model conforms to UL/CSA standards.
- VDE standard approved models are also available. Consult your Omron sales representative for availability.
- SPST-NO (1a) types conform to TV-8 rating, and DPST-NO (2a) types conform to TV-5 rating.
- Full-wave bridge rectifier compatible models are also available.

**RoHS Compliant**

### Model Number Legend

G4W-□-□□□□-□-□-□  
 1 2 3 4 5 6 7 8

#### 1. Number of poles

- 1: 1-pole/SPST-NO (1a)
- 2: 2-pole/DPST-NO (2a)

#### 2. Contact Form

- 1: SPST-NO (1a)
- 2: DPST-NO (2a)

#### 3. Contact Type

- 1: Single

#### 4. Enclosure rating

- 2: Unsealed

#### 5. Terminals

- P: Straight PCB

#### 6. Approved Standards

- US: UL, CSA

#### 7. TV Ratings

- TV5: TV-5
- TV8: TV-8

#### 8. Classification

- None: Standard
- Z : Full-wave rectifier

### Application Examples

- Power supplies

### Ordering Information

#### General-purpose Models (UL, CSA certified)

Contact form	SPST-NO (1a)		DPST-NO (2a)		Minimum packing unit
	Model	Rated coil voltage	Model	Rated coil voltage	
Standard	G4W-1112P-US-TV8	12 VDC	G4W-2212P-US-TV5	12 VDC	50 pcs/tray
		24 VDC		24 VDC	
		100 VDC		100 VDC	

Note: Contact your OMRON sales representative for fully sealed models.

#### Full-wave Rectifier Models (UL, CSA certified)

Contact form	SPST-NO (1a)		DPST-NO (2a)		Minimum packing unit
	Model	Rated coil voltage	Model	Rated coil voltage	
Standard	G4W-1112P-US-TV8-Z	12 VDC	G4W-2212P-US-TV5-Z	12 VDC	50 pcs/tray
		24 VDC		24 VDC	
		100 VDC		100 VDC	

Note: When ordering, add the rated coil voltage to the model number.

Example: G4W-1112P-US-TV8 DC12

Rated coil voltage

However, the notation of the coil voltage on the product case as well as on the packing will be marked as □□ VDC.

## ■ Ratings

### ● Coil

Item	Rated current (mA)	Coil resistance (Ω)	Must operate voltage (V)	Must release voltage (V)	Max. voltage (V)	Power consumption (mW)	
							% of rated voltage
Rated voltage	12 VDC	66.7	180	80% max.	10% min.	130% (at 23°C)	Approx. 0.8 W
	24 VDC	33.3	720				
	100 VDC	8	12,500				

- Note 1. The rated current and coil resistance are measured at a coil temperature of 23°C with a tolerance of ±15%.  
 2. The operating characteristics are measured at a coil temperature of 23°C.  
 3. The "Max. voltage" is the maximum voltage that can be applied to the relay coil.

### ● Contacts

Item	SPST-NO (1a)		DPST-NO (2a)	
	Resistive load (cosφ = 1)	Inductive load (cosφ = 0.4)	Resistive load (cosφ = 1)	Inductive load (cosφ = 0.4)
Contact material	Ag-Alloy (Cd free)			
Rated load	15 A at 250 VAC 15 A at 24 VDC	10 A at 250 VAC 7.5 A at 24 VDC	10 A at 250 VAC 10 A at 24 VDC	7.5 A at 250 VAC 5 A at 24 VDC
Rated carry current	15 A		10 A	
Max. switching voltage	250 VAC, 125 VDC			
Max. switching current	15 A		10 A	

## ■ Characteristics

Contact resistance *1	30 mΩ max.	
Operate time	20 ms max.	
Release time	5 ms max.	
Max. operating frequency	Mechanical	18,000 operations/hr
	Electrical	1,800 operations/hr
Insulation resistance *2	100 MΩ max.	
Dielectric strength	Between coil and contacts	4,000 VAC, 50/60 Hz for 1 min
	Between contacts of the same polarity	1,500 VAC, 50/60 Hz for 1 min
	Between contacts of different polarities	2,000 VAC, 50/60 Hz for 1 min
Impulse withstand voltage	Between coil and contacts	10,000 V
Insulation distance	Between coil and contacts	Clearance: 8 mm, Creepage: 8 mm
Vibration resistance	Destruction	10 to 55 to 10 Hz, 0.75 mm single amplitude (1.5 mm double amplitude)
	Malfunction	10 to 55 to 10 Hz, 0.75 mm single amplitude (1.5 mm double amplitude)
Shock resistance	Destruction	1,000 m/s <sup>2</sup>
	Malfunction	150 m/s <sup>2</sup>
Durability	Mechanical	5,000,000 operations min. (at 18,000 operations/hr)
	Electrical	100,000 operations min. (rated load, at 1,800 operations/hr)
Failure rate (P level) (reference value) *3	100 mA at 5 VDC	
Ambient operating temperature	-25°C to 55°C (with no icing or condensation)	
Ambient operating humidity	5% to 85%	
Weight	Approx. 29 g	

- Note: The above values are initial values.  
 \*1. The contact resistance was measured with 1 A at 5 VDC with a fall-of-potential method.  
 \*2. The insulation resistance was measured with a 500 VDC Megger Tester applied to the same parts as those for checking the dielectric strength.  
 \*3. This value was measured at a switching frequency of 120 operations/min.

## ■ Engineering Data

### ● Maximum Switching Capacity SPST-NO (1a)

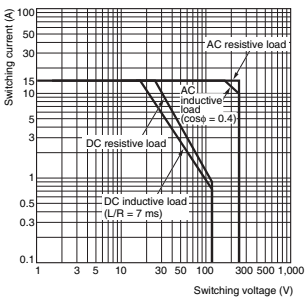

### DPST-NO (2a)

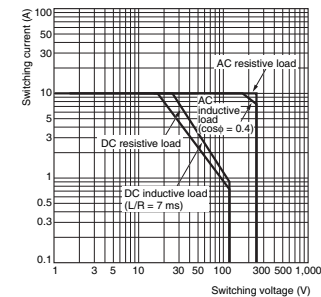

### ● Durability SPST-NO (1a) AC Load

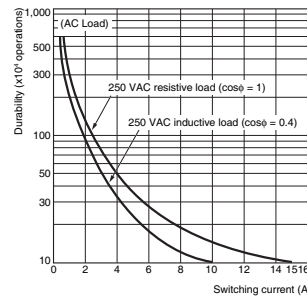

### DPST-NO (2a) AC Load

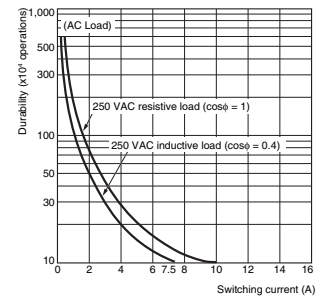

### ● Durability SPST-NO (1a) DC Load

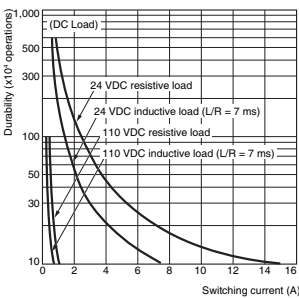

### DPST-NO (2a) DC Load

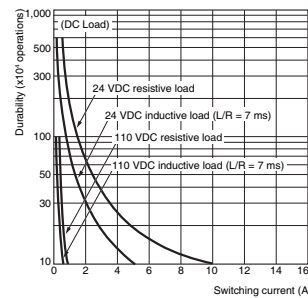

### ● Ambient Temperature vs. Maximum Coil Voltage

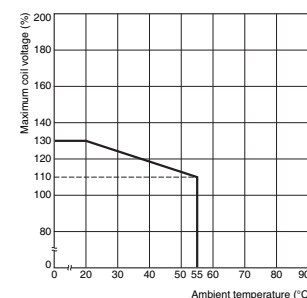

### ● Ambient Temperature vs. Must Operate and Must Release Voltage G4W-2212P-US-TV5

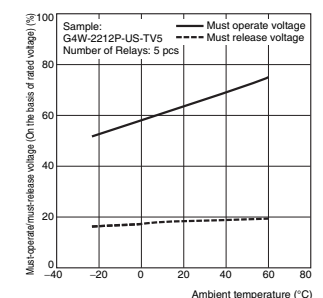

Note: The maximum coil voltage refers to the maximum value in a varying range of operating power voltage, not a continuous voltage.

### ● Shock Malfunction

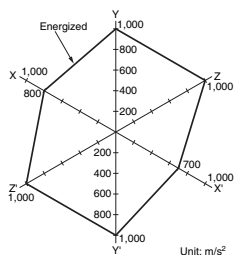

G4W-1112P-US-TV8  
 Number of Relays: 5 pcs  
 Test Conditions: Shock is applied in ±X, ±Y, and ±Z directions three times each with and without energizing the Relays to check the number of contact malfunctions.  
 Standard value: 150 m/s<sup>2</sup>

## ■Dimensions

### Standard model

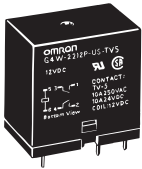

This illustration is the G4W-2212P-US-TV5 model.

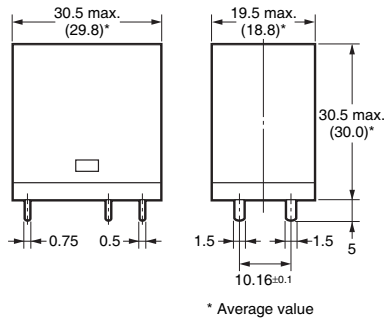

### PCB Mounting Holes (BOTTOM VIEW) Tolerance: ±0.1 mm G4W-1112P-US-TV8(-Z)

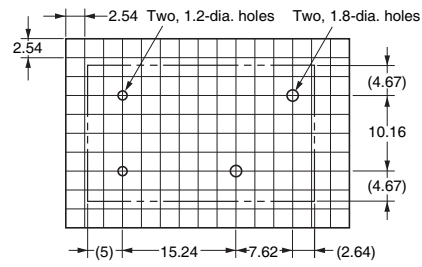

### Terminal Arrangement/ Internal Connections (BOTTOM VIEW)

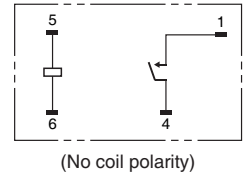

### G4W-2212P-US-TV5(-Z)

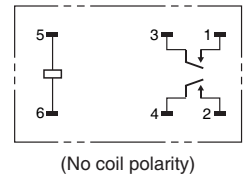
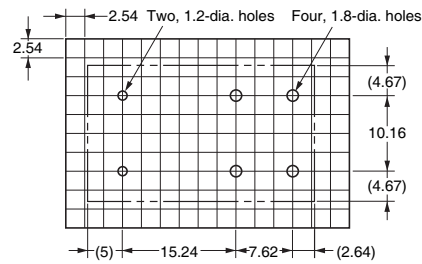

G  
4  
W

## ■Approved Standards

- The approval rating values for overseas standards are different from the performance values determined individually. Confirm the values before use.

UL Recognized: (File No. E41643)

Model	Number of poles	Coil ratings	Contact ratings	Number of test operations
G4W-1112( ) -US-TV8(-Z)	1	12 to 100 VDC	15 A, 250 VAC (General Use) at 40°C	6,000
			15A, 24 VDC at 40°C	
			TV-8 at 40°C	
			1/2HP, 125 VAC at 40°C	1,000
			3/4HP, 240 VAC at 40°C	
			1HP, 250 VAC at 40°C	
G4W-2212( ) -US-TV5(-Z)	2		15 A, 250 VAC (General Use) at 40°C	6,000
			15A, 36 VDC at 40°C	
			TV-5 at 40°C	
			1/4HP, 125 VAC at 40°C	1,000
			1/2HP, 250 VAC at 40°C	
			1/3HP, 125 VAC at 40°C	
		1/4HP, 250 VAC at 40°C		

CSA Certified: (File No. LR31928)

Model	Number of poles	Coil ratings	Contact ratings	Number of test operations
G4W-1112( )-US-TV8(-Z)	1	12 to 100 VDC	15 A, 250 VAC (General Use) at 40°C	6,000
			15A, 24 VDC at 40°C	
			TV-8 at 40°C	
			1/2HP, 125 VAC at 40°C	1,000
			3/4HP, 240 VAC at 40°C	
			1HP, 250 VAC at 40°C	
G4W-2212( )-US-TV5(-Z)	2		15 A, 250 VAC (General Use) (Same Polarity) at 40°C	6,000
			10 A, 250 VAC (General Use) at 40°C	
			15A, 24 VDC at 40°C	
			TV-5 at 40°C	25,000
			1/2HP, 250 VAC at 40°C	
			1/3HP, 125 VAC at 40°C	

## ■ Precautions

● Please refer to “PCB Relays Common Precautions” for correct use.

### Correct Use

#### ● Mounting

- When mounting more than two Relays on a PCB, keep the gap as shown in the following figure.
- No specified mounting direction.
- Not compatible with sockets.

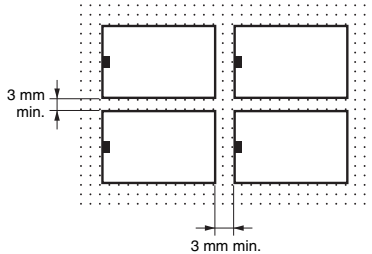

- There is the current-carrying metal part on the coil terminal.

Do not mount to the PCB with patterned metal surface.

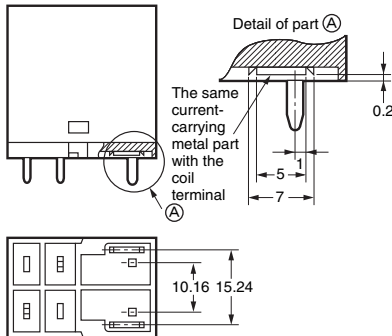

#### ● Other Precautions

- This Relay is suitable for power load switching of motors, transformers, solenoids, lamps, heaters, etc. Do not use the G4W to switch micro loads less than 100 mA, such as in signal applications.

· Application examples provided in this document are for reference only. In actual applications, confirm equipment functions and safety before using the product.  
 · Consult your OMRON representative before using the product under conditions which are not described in the manual or applying the product to nuclear control systems, railroad systems, aviation systems, vehicles, combustion systems, medical equipment, amusement machines, safety equipment, and other systems or equipment that may have a serious influence on lives and property if used improperly. Make sure that the ratings and performance characteristics of the product provide a margin of safety for the system or equipment, and be sure to provide the system or equipment with double safety mechanisms.

**Note: Do not use this document to operate the Unit.**