


**35M** SERIESLONGEST HISTORY & EXPERIENCE  
IN CAN STACK STEP MOTOR**GENERAL SPECIFICATIONS**

Step Angle	7.5° / 15° / 18°
Step Accuracy	± 0.5° / ± 1° / ± 1.2°
Operating Temperature	100°C Max
Ambient Temperature Range	-20°C ~ +70°C
Insulation Resistance at 500Vdc	100MΩ
Dielectric Withstanding Voltage	650 ± 50 VRMS, 2 sec

 [CLICK HERE TO PRINT THIS SERIES](#)  
OPENS PDF IN NEW WINDOW

The specifications in this publication are believed to be accurate and reliable. However, it is the responsibility of the product user to determine the suitability of Portescap products for a specific application. While defective products will be replaced without charge if promptly returned, no liability is assumed beyond such replacement.

Portescap Danaher Motion motors will not be CE marked where the Low Voltage Directive, the Electro-Magnetic Compatibility or other appropriate EU directives are not applicable - this is an EU legal requirement.

## TECHNICAL SPECIFICATIONS

	UNIPOLAR					
Part Number	35M020B1U	35M020B2U	35M024B1U	35M024B2U	35M048B1U	35M048B2U
DC Op. Voltage	5	12	5	12	5	12
Resistance per Winding (ohms)	12.5	72	12.5	72	12.5	72
Inductance per Winding (mH)	6.8	32	7.2	32.8	7.8	36
Holding Torque* (mNm/oz-in)	13.4 / 1.9	13.4 / 1.9	16.93 / 2.4	16.93 / 2.4	18.35 / 2.6	18.35 / 2.6
Rotor Moment of Inertia (g.m <sup>2</sup> )	2 x 10 <sup>-4</sup>	2 x 10 <sup>-4</sup>	2 x 10 <sup>-4</sup>	2 x 10 <sup>-4</sup>	2 x 10 <sup>-4</sup>	2 x 10 <sup>-4</sup>
Detent Torque (mNm/oz-in)	2.2 / 0.30	2.2 / 0.30	2.2 / 0.30	2.2 / 0.30	2.2 / 0.30	2.2 / 0.30
Step Angle	18°	18°	15°	15°	7.5°	7.5°
Step Angle Tolerance*	± 1.2°	± 1.2°	± 1°	± 1°	± 0.5°	± 0.5°
Steps per Rev.*	20	20	24	24	48	48
Max. Operating Temp.	100°C	100°C	100°C	100°C	100°C	100°C
Ambient Temp. Range						
Operating	-20°C to 70°C	-20°C to 70°C	-20°C to 70°C	-20°C to 70°C	-20°C to 70°C	-20°C to 70°C
Storage	-40°C to 85°C	-40°C to 85°C	-40°C to 85°C	-40°C to 85°C	-40°C to 85°C	-40°C to 85°C
Bearing Type	Sintered bronze sleeve	Sintered bronze sleeve	Sintered bronze sleeve	Sintered bronze sleeve	Sintered bronze sleeve	Sintered bronze sleeve
Insulation Resistance at 500Vdc	100 megohms	100 megohms	100 megohms	100 megohms	100 megohms	100 megohms
Dielectric Withstanding Voltage	650 ± 50 VRMS, 2 sec	650 ± 50 VRMS, 2 sec	650 ± 50 VRMS, 2 sec	650 ± 50 VRMS, 2 sec	650 ± 50 VRMS, 2 sec	650 ± 50 VRMS, 2 sec
Weight (g/oz)	79 / 2.8	79 / 2.8	79 / 2.8	79 / 2.8	79 / 2.8	79 / 2.8
Leadwires	26 AWG, UL Style 1430	26 AWG, UL Style 1430	26 AWG, UL Style 1430	26 AWG, UL Style 1430	26 AWG, UL Style 1430	26 AWG, UL Style 1430

\* Measured with 2 phases energized

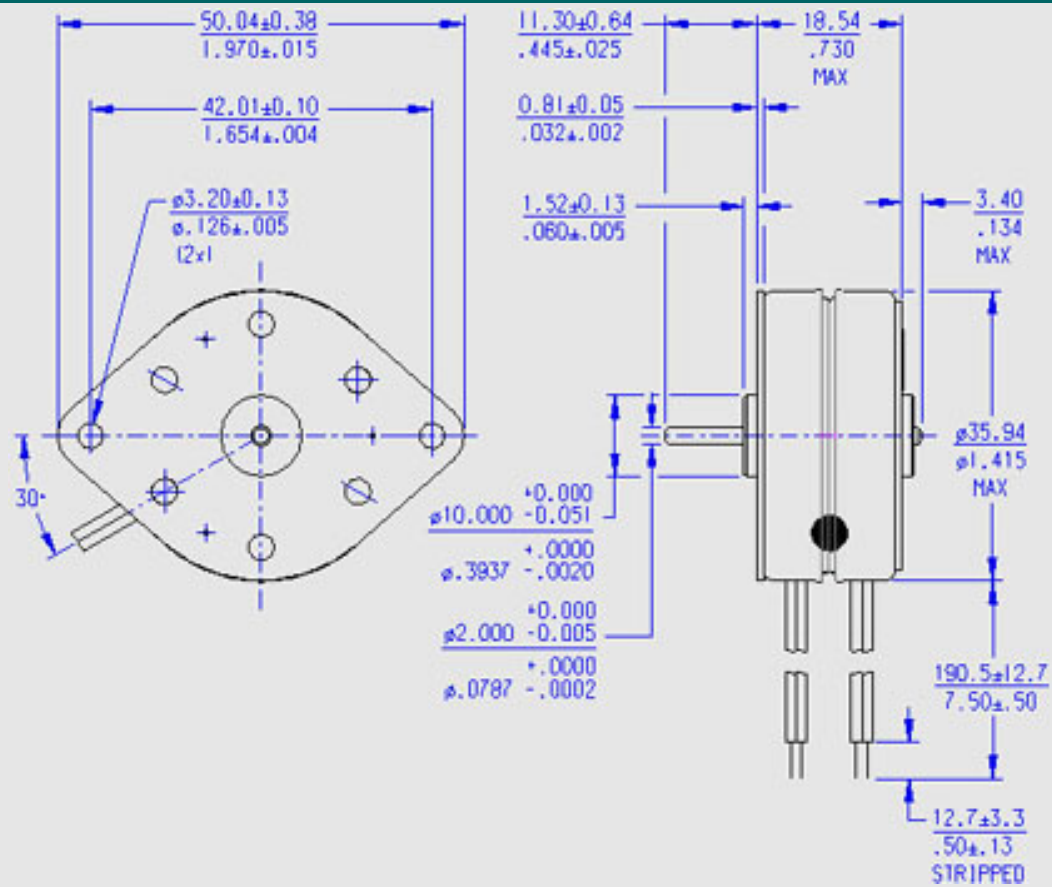
## TECHNICAL SPECIFICATIONS

	BIPOLAR					
Part Number	35M020B1B	35M020B2B	35M024B1B	35M024B2B	35M048B1B	35M048B2B
DC Op. Voltage	5	12	5	12	5	12
Resistance per Winding (ohms)	12.5	72	12.5	72	12.5	72
Inductance per Winding (mH)	13.6	73	14.2	76	16.4	86
Holding Torque* (mNm/oz-in)	18.3 / 2.6	18.3 / 2.6	19.76 / 2.8	19.76 / 2.8	19.76 / 2.8	19.76 / 2.8
Rotor Moment of Inertia (g.m <sup>2</sup> )	2 x 10 <sup>-4</sup>	2 x 10 <sup>-4</sup>	2 x 10 <sup>-4</sup>	2 x 10 <sup>-4</sup>	2 x 10 <sup>-4</sup>	2 x 10 <sup>-4</sup>
Detent Torque (mNm/oz-in)	2.2 / 0.30	2.2 / 0.30	2.2 / 0.30	2.2 / 0.30	2.2 / 0.30	2.2 / 0.30
Step Angle	18°	18°	15°	15°	7.5°	7.5°
Step Angle Tolerance*	± 1.2°	± 1.2°	± 1°	± 1°	± 0.5°	± 0.5°
Steps per Rev.*	20	20	24	24	48	48
Max. Operating Temp.	100°C	100°C	100°C	100°C	100°C	100°C
Ambient Temp. Range						
Operating	-20°C to 70°C	-20°C to 70°C	-20°C to 70°C	-20°C to 70°C	-20°C to 70°C	-20°C to 70°C
Storage	-40°C to 85°C	-40°C to 85°C	-40°C to 85°C	-40°C to 85°C	-40°C to 85°C	-40°C to 85°C
Bearing Type	Sintered bronze sleeve	Sintered bronze sleeve	Sintered bronze sleeve	Sintered bronze sleeve	Sintered bronze sleeve	Sintered bronze sleeve
Insulation Resistance at 500Vdc	100 megohms	100 megohms	100 megohms	100 megohms	100 megohms	100 megohms
Dielectric Withstanding Voltage	650 ± 50 VRMS, 2 sec	650 ± 50 VRMS, 2 sec	650 ± 50 VRMS, 2 sec	650 ± 50 VRMS, 2 sec	650 ± 50 VRMS, 2 sec	650 ± 50 VRMS, 2 sec
Weight (g/oz)	79 / 2.8	79 / 2.8	79 / 2.8	79 / 2.8	79 / 2.8	79 / 2.8
Leadwires	26 AWG, UL Style 1430	26 AWG, UL Style 1430	26 AWG, UL Style 1430	26 AWG, UL Style 1430	26 AWG, UL Style 1430	26 AWG, UL Style 1430

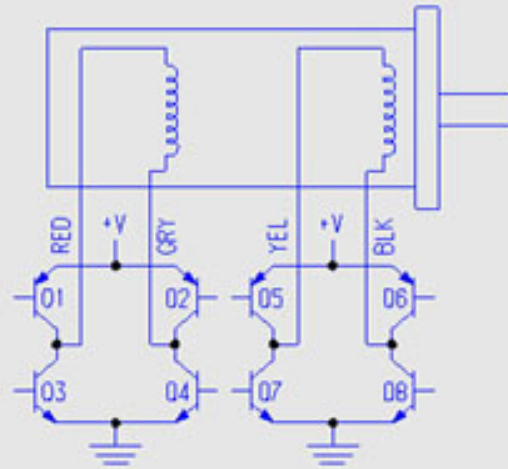
\* Measured with 2 phases energized

## MECHANICAL DIMENSIONS

UNITS = MM / INCHES



## WIRING DIAGRAM

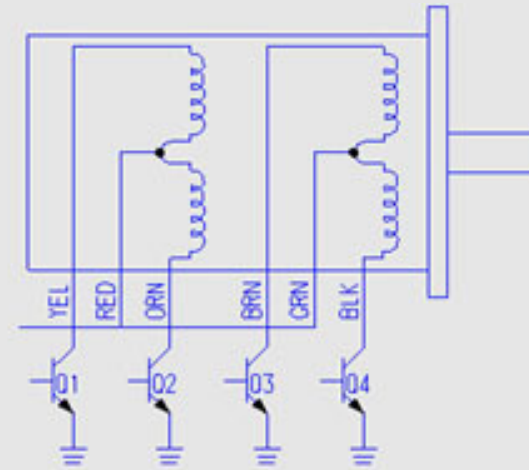


BIPOLAR

STEP	01-04	02-03	05-08	06-07
1	ON	OFF	ON	OFF
2	ON	OFF	OFF	ON
3	OFF	ON	OFF	ON
4	OFF	ON	ON	OFF
1	ON	OFF	ON	OFF

CW ROTATION ↓

↑ CCW ROTATION



UNIPOLAR

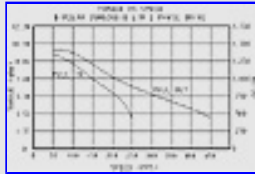
STEP	01	02	03	04
1	ON	OFF	ON	OFF
2	ON	OFF	OFF	ON
3	OFF	ON	OFF	ON
4	OFF	ON	ON	OFF
1	ON	OFF	ON	OFF

CW ROTATION ↓

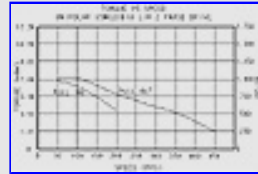
↑ CCW ROTATION

MOTOR DYNAMICS

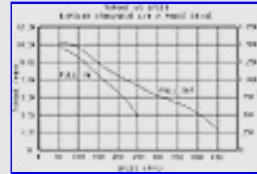
CLICK ON A THUMBNAIL TO MAGNIFY



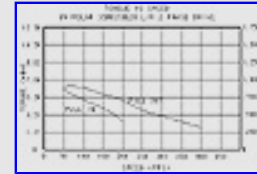
35M020B1B, Bipolar, L/R Drive



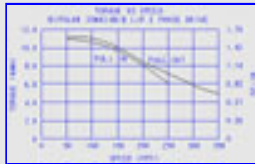
35M020B1U, Unipolar, L/R Drive



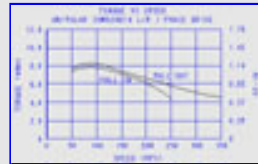
35M020B2B, Bipolar, L/R Drive



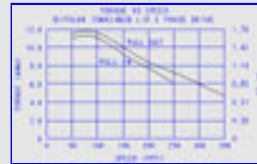
35M020B2U, Unipolar, L/R Drive



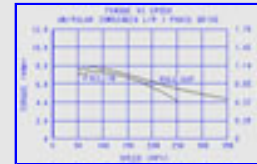
35M024B1B, Bipolar, L/R Drive



35M024B1U, Unipolar, L/R Drive



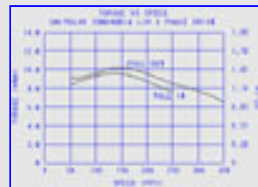
35M024B2B, Bipolar, L/R Drive



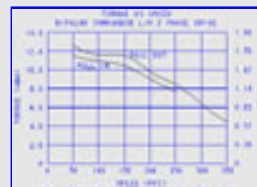
35M024B2U, Unipolar, L/R Drive



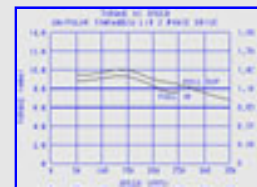
35M048B1B, Bipolar, L/R Drive



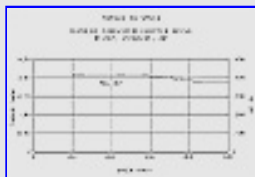
35M048B1U, Unipolar, L/R Drive



35M048B2B, Bipolar, L/R Drive



35M048B2U, Unipolar, L/R Drive



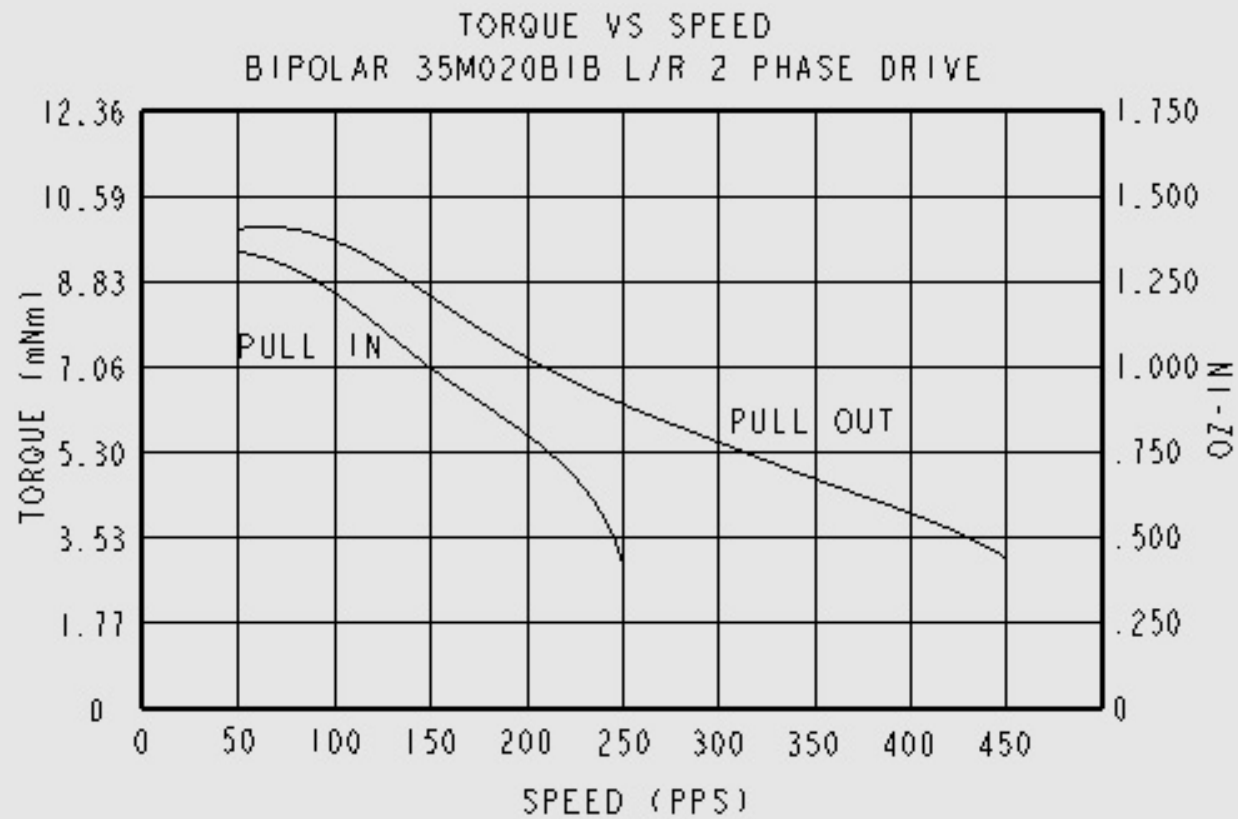
35M020B1B, Bipolar, Chopper Drive



35M024B1B, Bipolar, Chopper Drive



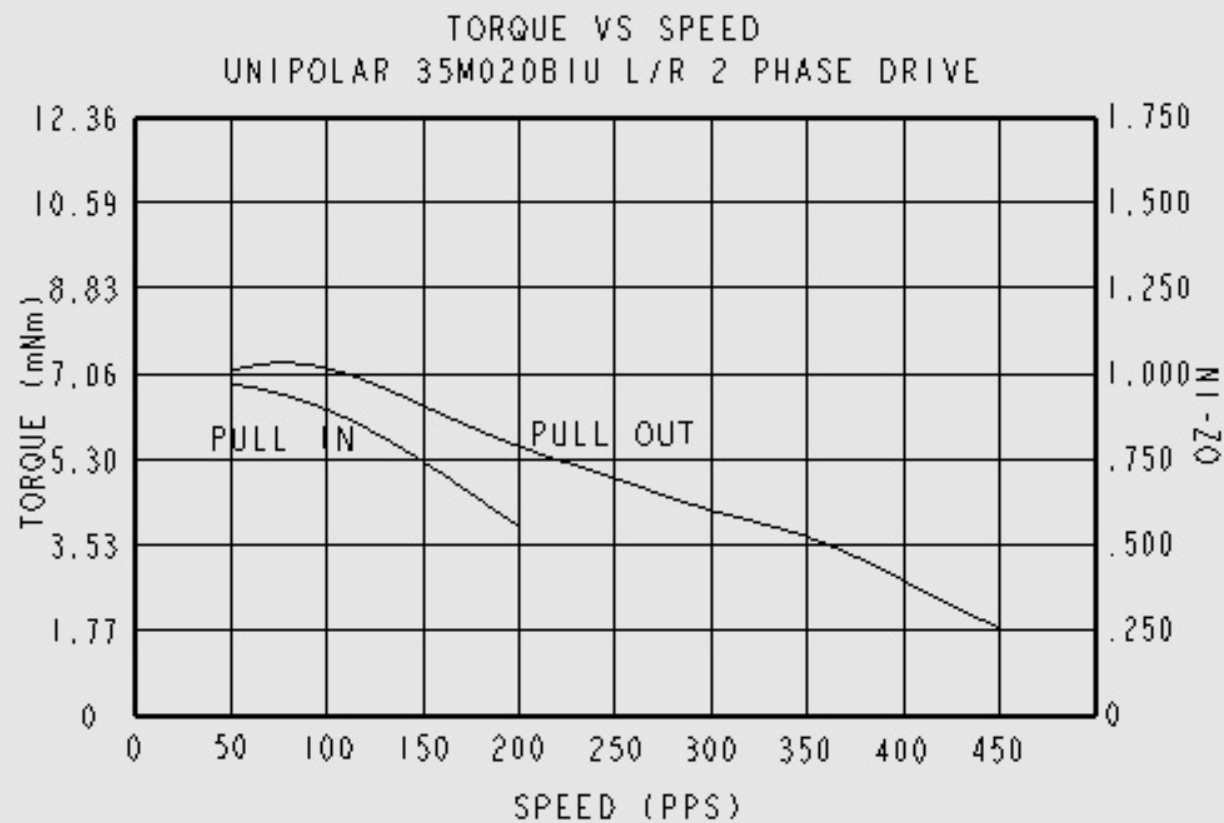
35M048B1B, Bipolar, Chopper Drive



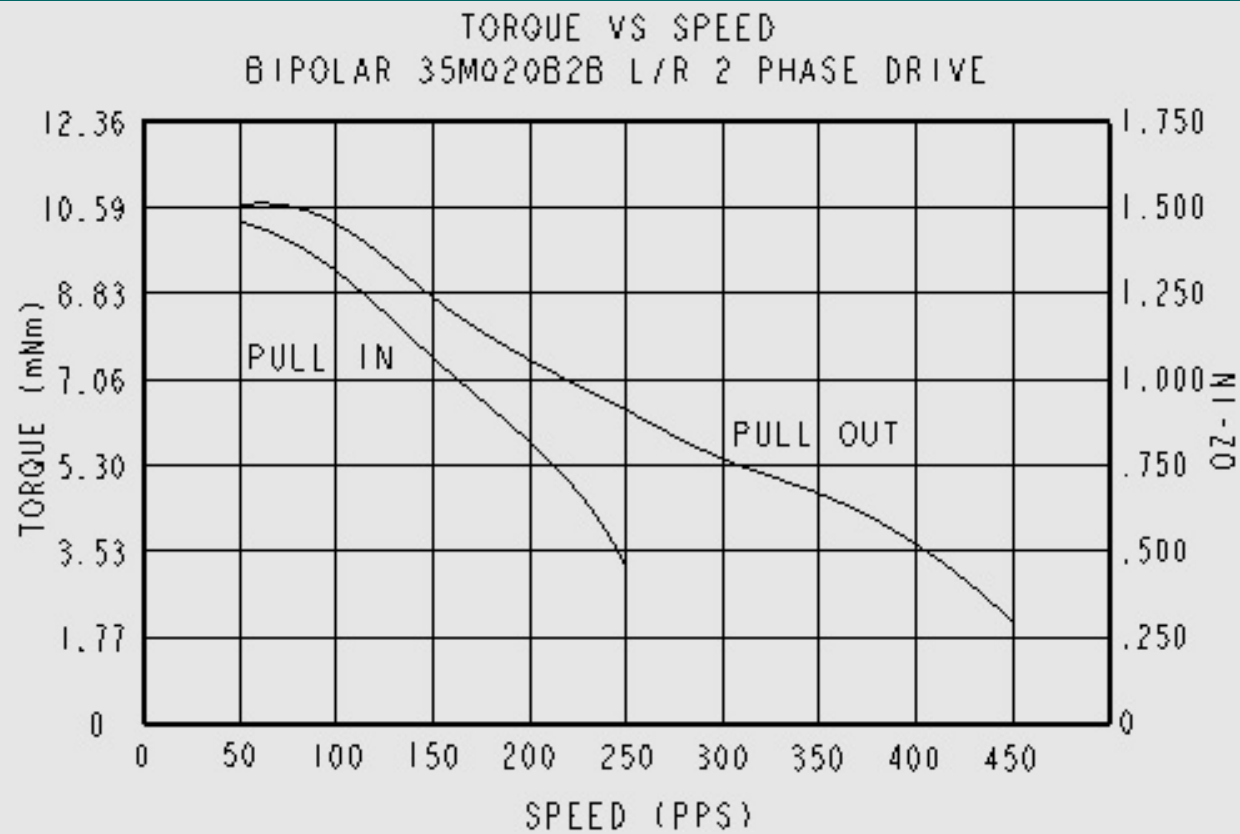
## MOTOR DYNAMICS

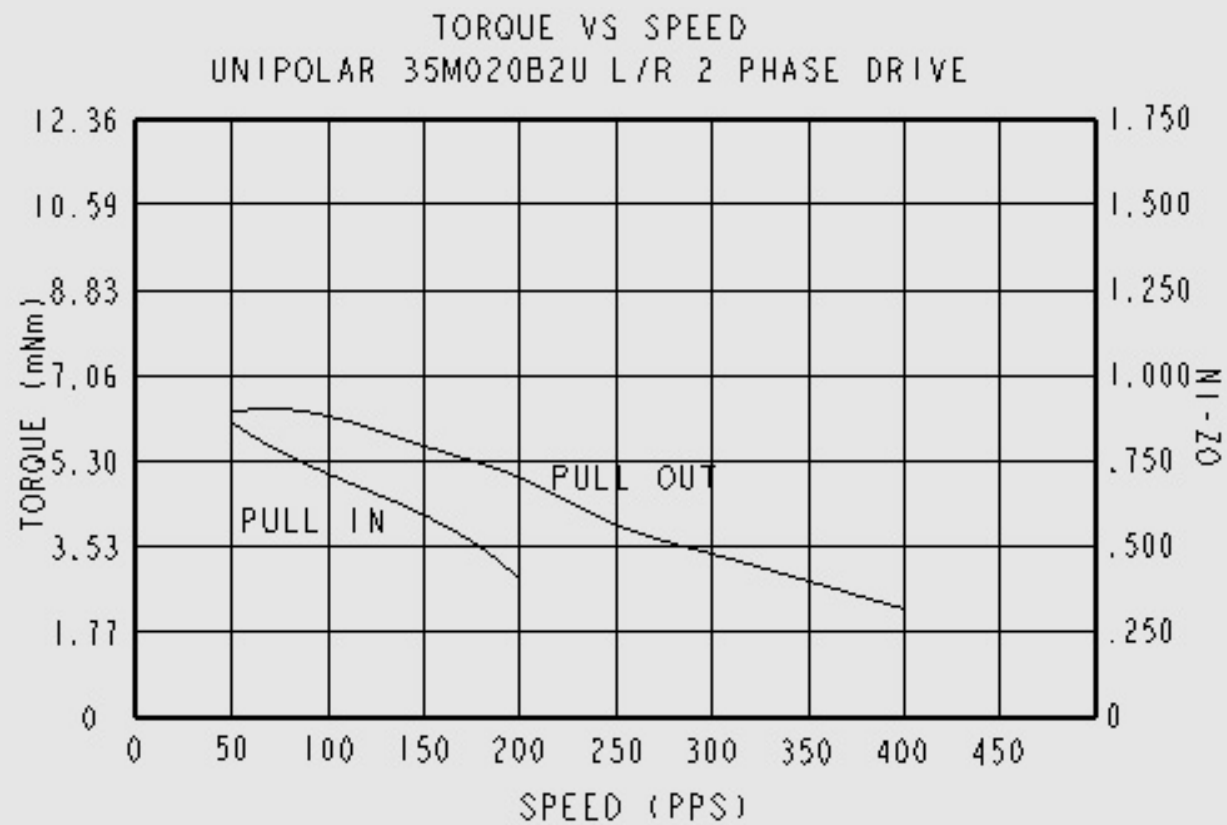


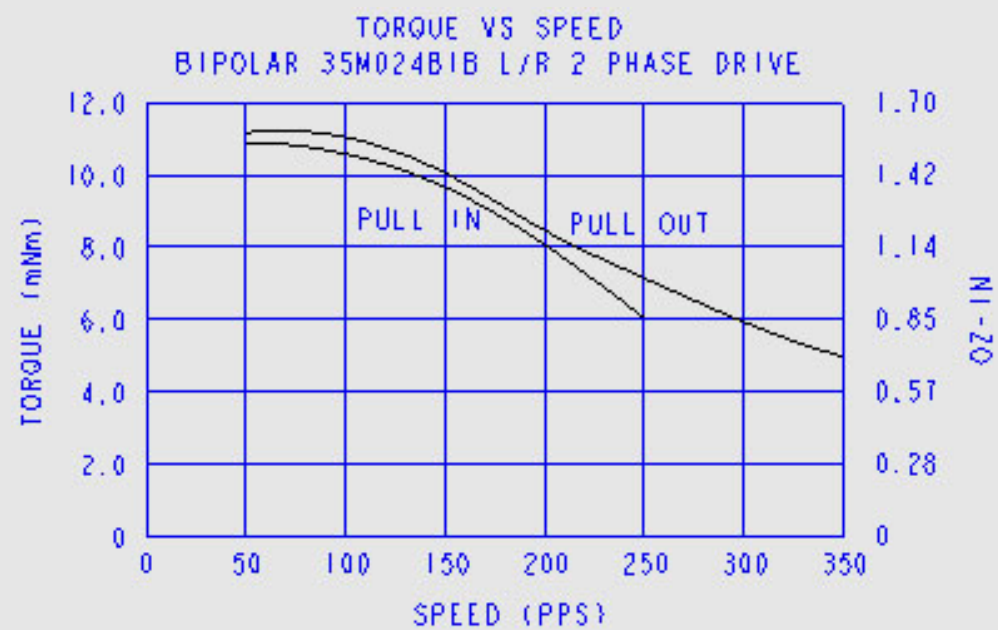
CHART INDEX

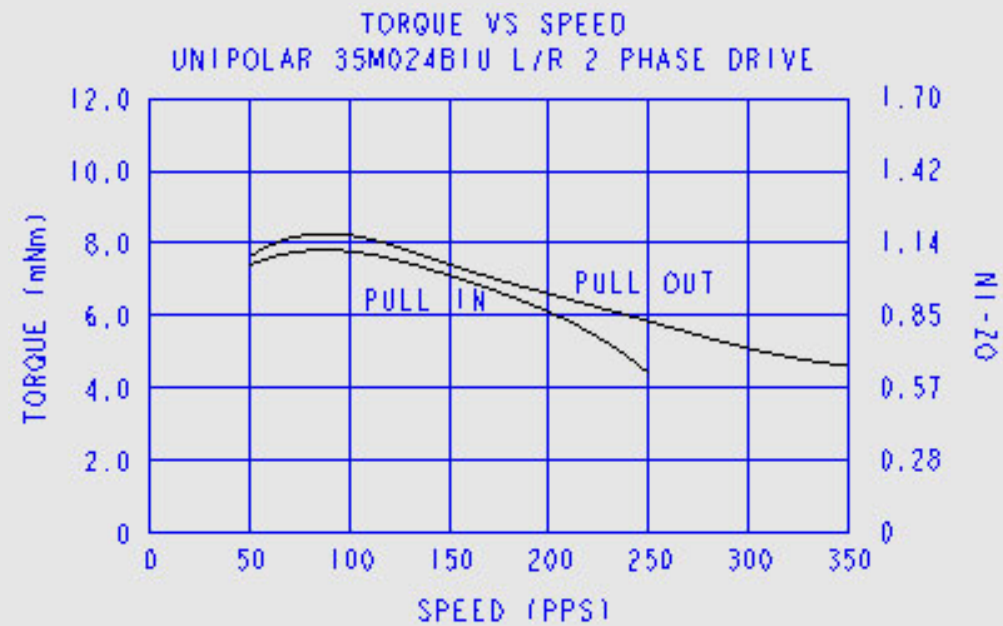


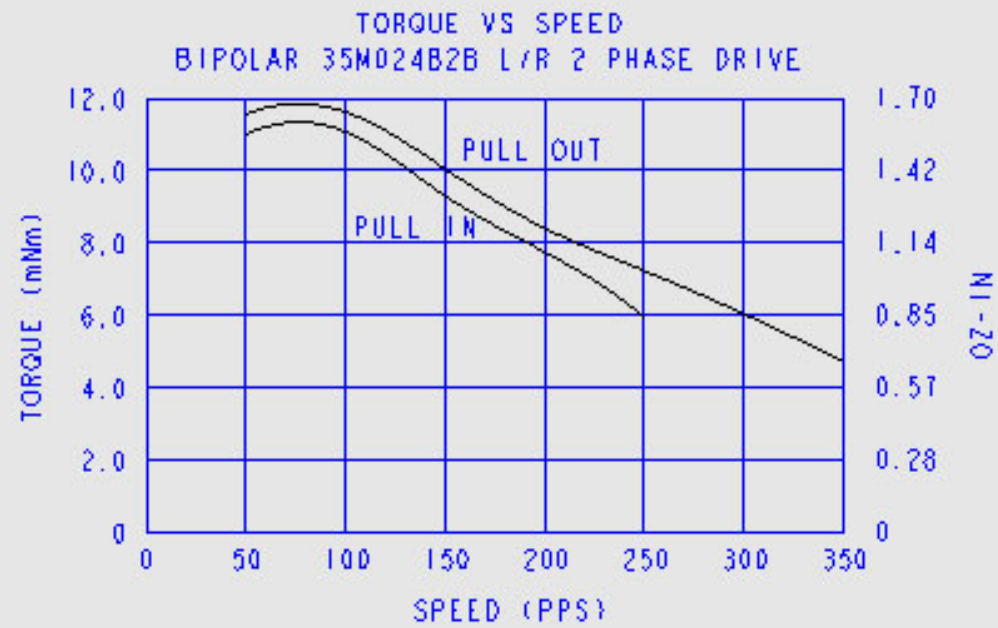








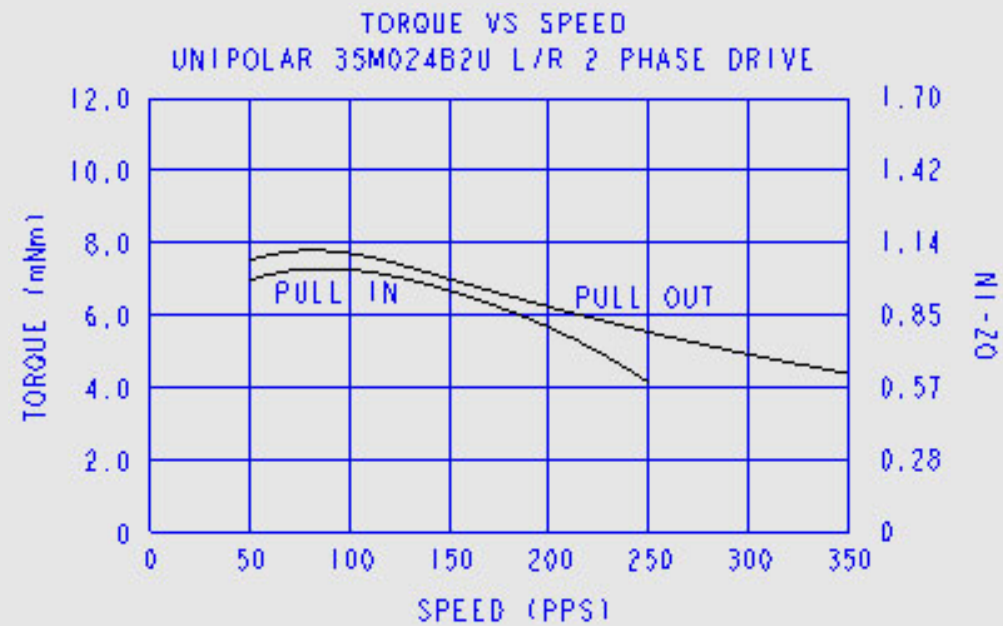


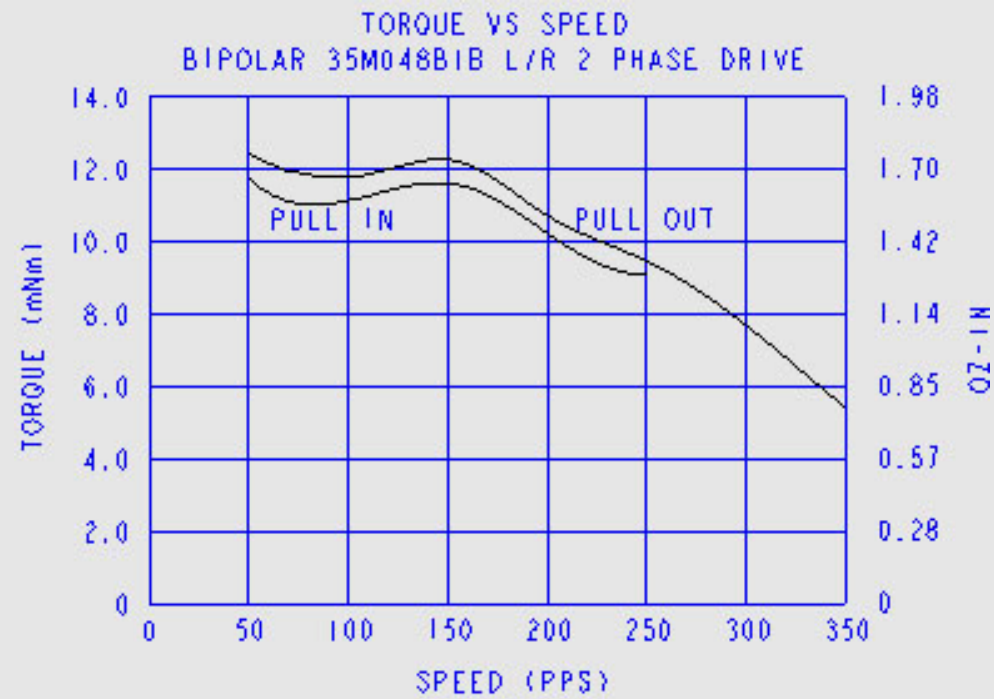


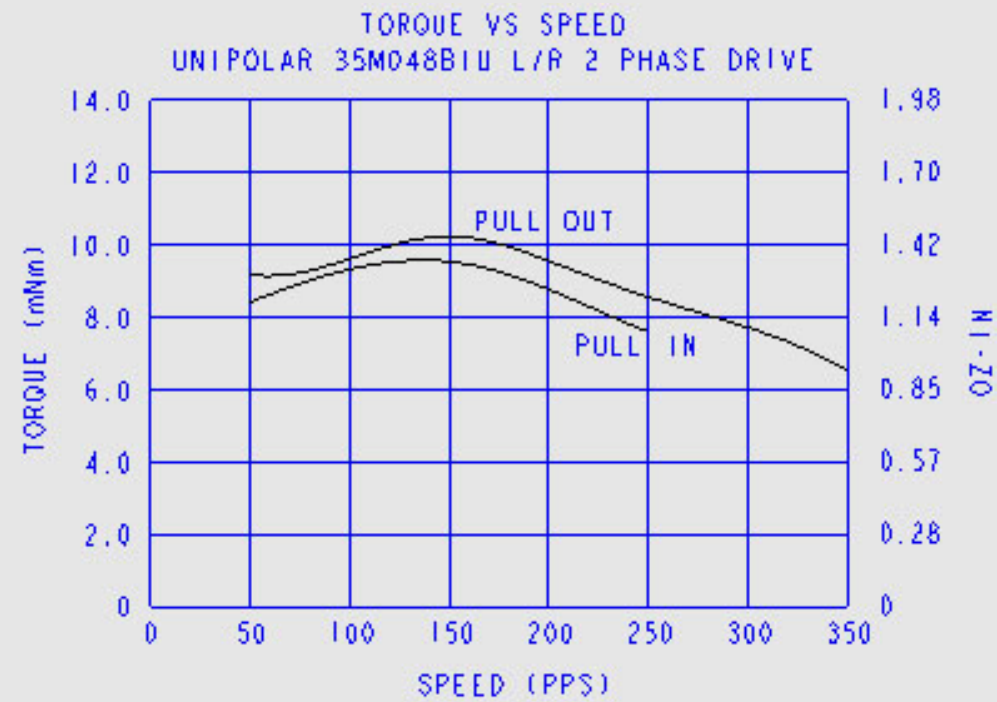
## MOTOR DYNAMICS



CHART INDEX





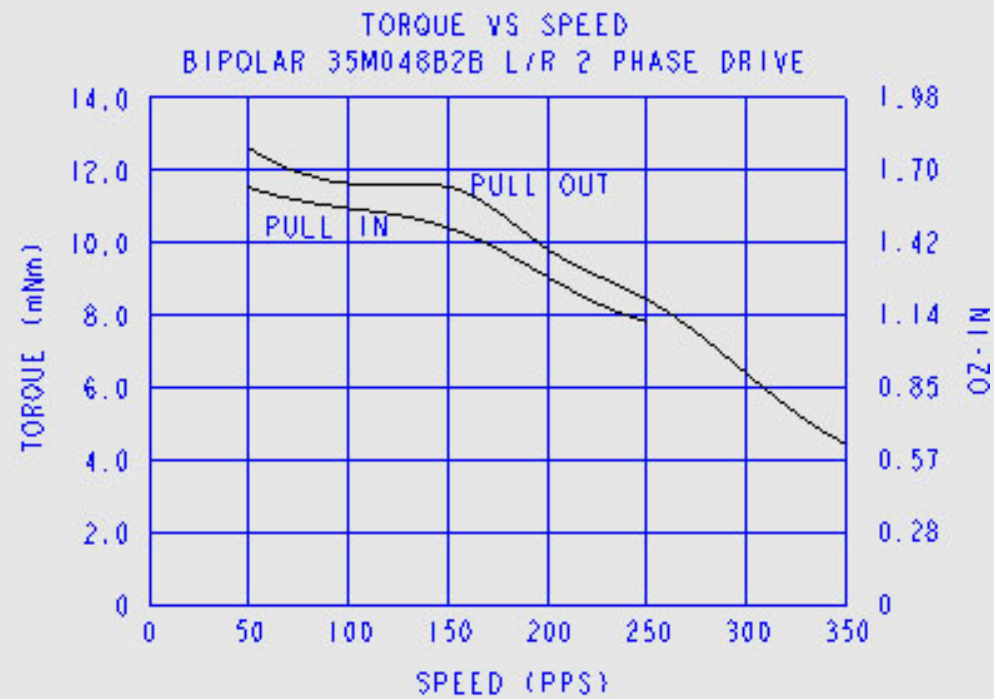




## MOTOR DYNAMICS



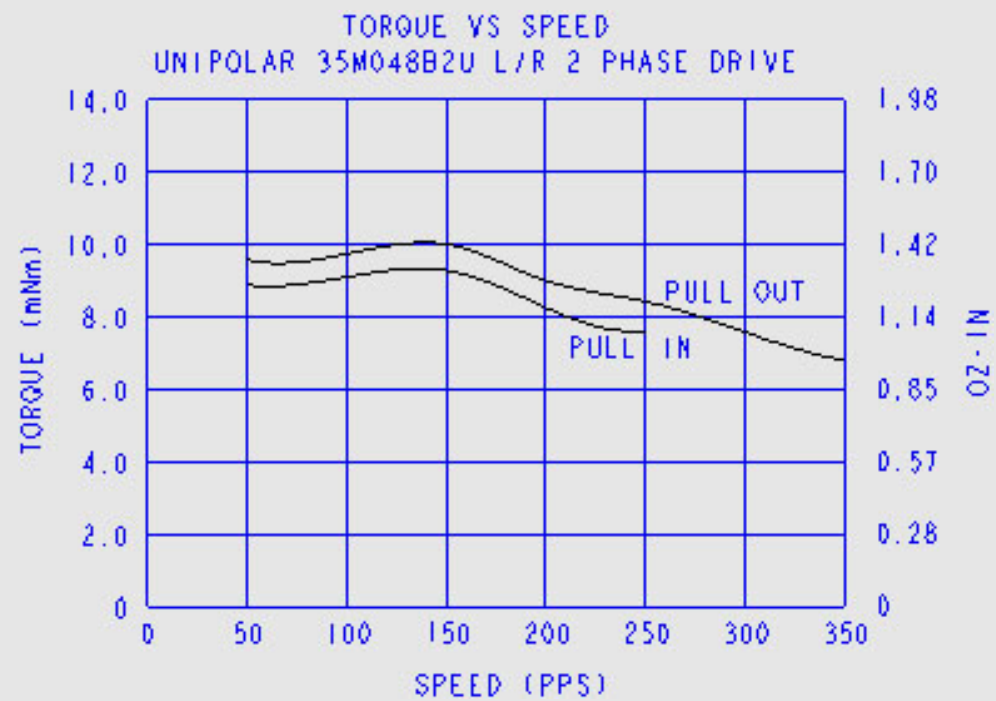
CHART INDEX



## MOTOR DYNAMICS



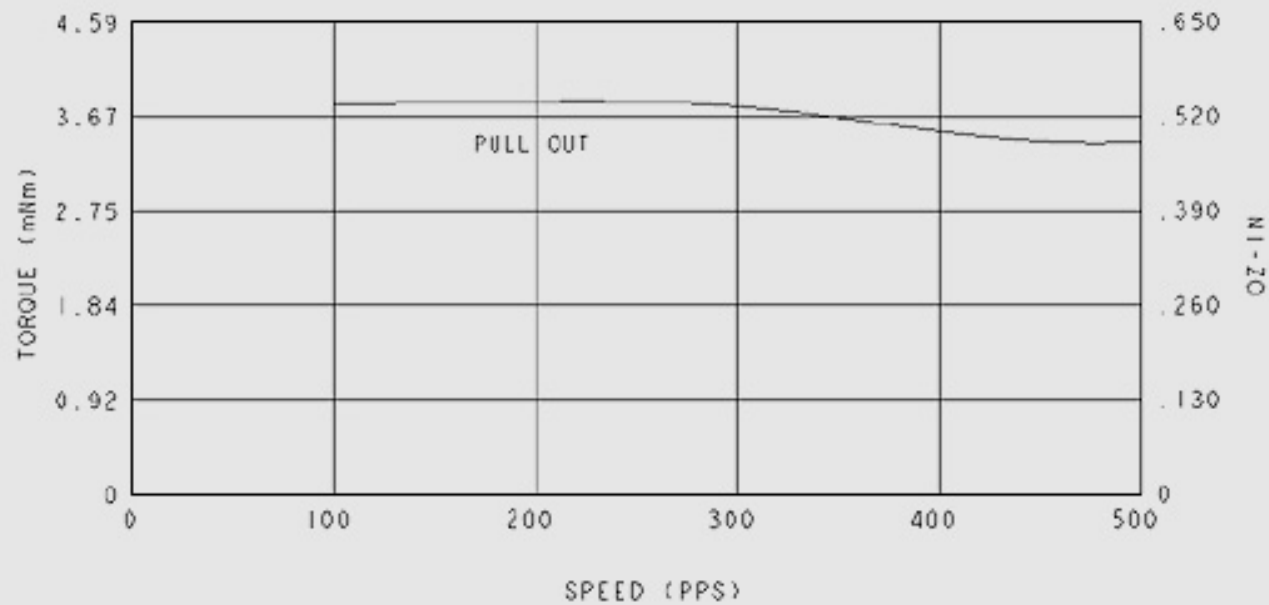
CHART INDEX





## TORQUE VS SPEED

BIPOLAR 35M020BIB CHOPPER DRIVE  
@ 36V, 200mA/Ø, 2Ø

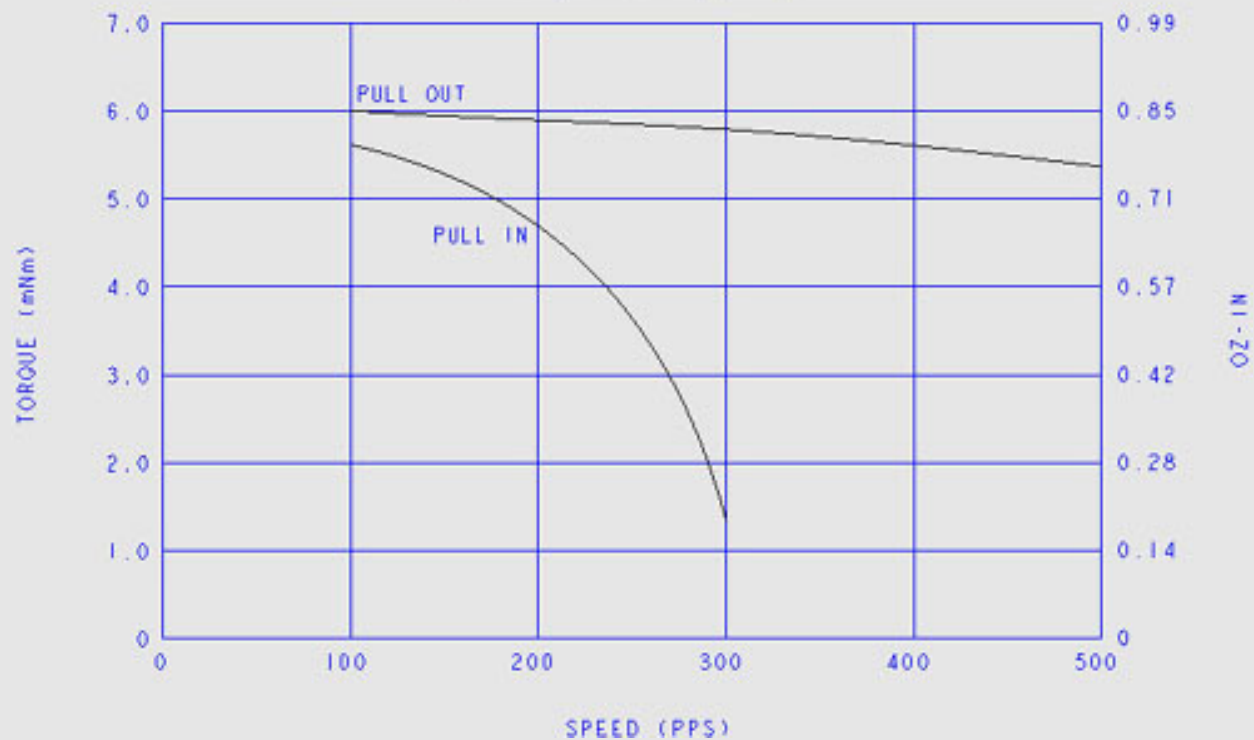




## TORQUE VS SPEED

BIPOLAR 35M024B1B CHOPPER DRIVE

⊕ 36V, 200mA/⌀, 2⌀





## TORQUE VS SPEED

BIPOLAR 35M048B1B CHOPPER DRIVE  
@ 36V, 200mA/ϕ, 2ϕ

