

DETAILS

Product Number	F13402_ANGELINA-W
Family	ANGELINA
Type	Reflector
Color	metal
Diameter	82 mm
Height	31 mm
Style	round
Optic Material	PC
Holder Material	
Fastening	
Status	production ready
ROHS Compliant	Yes
Date Updated	31/01/2017



OPTICAL PROPERTIES

LED	Viewing	Light	Effi-		Connector
	Angle	Beam	ciency	cd/lm	
BXRA ES Rectangle	43 deg	Wide	93 %	1.210	IDEAL: 50-2100BL + 50-2100AN
V22 Gen6	57 deg	Wide	92 %	0.900	IDEAL: 50-2204-CT + 50-2100AN
V13 Gen7	50 deg	Wide	92 %	1.000	TE: 2213254-2 + OPTIC CLIP Z50 TYPE1 2213194-1
V22 Gen7	sim: 43	Wide	sim: 94 %	sim: 1.279	IDEAL: 50-2204-CT + 50-2100AN
V13 Gen7	sim: 38	Wide	sim: 93 %	sim: 1.507	IDEAL: 50-2103CT + 50-2100AN
CLL03x/CLU03x	43 deg	Wide	93 %	1.190	IDEAL: 50-2103CT + 50-2100AN
CLL03x/CLU03x	48 deg	Wide	94 %	1.090	TE: 2213254-2 + OPTIC CLIP Z50 TYPE1 2213194-1
CLU720/721	38 deg	Wide	93 %	1.200	IDEAL: 50-2103CT + 50-2100AN
CLU720/721	45 deg	Wide	94 %	1.100	TE: 2213254-2 + OPTIC CLIP Z50 TYPE1 2213194-1
CLL04x/CLU04x	43 deg	Wide	91 %	1.100	IDEAL: 50-2204-CT + 50-2100AN
CLU730/731	56 deg	Wide	91 %	1.100	IDEAL: 50-2204-CT + 50-2100AN
CXA/B 25xx	47 deg	Wide	94 %	1.090	IDEAL: 50-2102CR + 50-2100AN
CXA/B 30xx	52 deg	Wide	93 %	0.980	IDEAL: 50-2234C + 50-2100AN
CXA/B 1816 & CXA/B 1820 & CXA 1850	39 deg	Wide	94 %	1.280	IDEAL: 50-2101CR + 50-2100AN
CXA/B 3590	66 deg	Wide	93 %	0.790	IDEAL: 50-2303CR + 50-2300AN
COB 10W/13W/17W/24W	40 deg	Wide	93 %	1.250	IDEAL: 50-2100LG + 50-2100AN
LUXEON K16	48 deg	Wide	94 %	1.000	TE: 2213134-2 + OPTIC CLIP Z50 TYPE1 2213194-1
LUXEON K12	45 deg	Wide	94 %	1.150	TE: 2213134-2 + OPTIC CLIP Z50 TYPE1 2213194-1
LUXEON CoB 1204/1205	45 deg	Wide	94 %	1.200	TE: 2213130-2 + OPTIC CLIP Z50 TYPE1 2213194-1
LUXEON CoB 1208	48 deg	Wide	93 %	1.100	TE: 2213130-2 + OPTIC CLIP Z50 TYPE1 2213194-1
LUXEON CoB 1204/1205	40 deg	Wide	93 %	1.240	IDEAL: 50-2100SH + 50-2100AN
LUXEON CoB 1208	44 deg	Wide	93 %	1.170	IDEAL: 50-2100SH + 50-2100AN
LUXEON CoB 1211	53 deg	Wide	91 %	0.910	IDEAL: 50-2204-CT + 50-2100AN
CXM-14	48 deg	Wide	93 %	1.070	TE: 2213254-2 + OPTIC CLIP Z50 TYPE1 2213194-1
COB J-Type	43 deg	Wide	94 %	1.190	IDEAL: 50-2103NC + 50-2100AN

OPTICAL PROPERTIES

LED	Viewing Angle	Light Beam	Efficiency	cd/lm	Connector
COB L-Type (LES 11)	39 deg	Wide	91 %	1.230	IDEAL: 50-2100NC + 50-2100AN
COB L-Type (LES 11)	51 deg	Wide	94 %	1.015	Molex: 180580-0005
COB L-Type (LES 11)	48 deg	Wide	92 %	1.060	TE: 2213382-2 + OPTIC CLIP Z50 TYPE1 2213194-1
PrevaLED Core Z3 LES9	38 deg	Wide	93 %	1.280	TE: OPTIC CLIP Z50 TYPE1 2213194-1
PrevaLED Core Z3 LES23	55 deg	Wide	94 %	0.950	TE: OPTIC CLIP Z50 TYPE1 2213194-1
PrevaLED Core Z3 LES19	50 deg	Wide	94 %	1.040	TE: OPTIC CLIP Z50 TYPE1 2213194-1
Soleriq S13	47 deg	Wide	94 %	1.200	TE: 2213401-2 + OPTIC CLIP Z50 TYPE1 2213194-1
Soleriq S19	49 deg	Wide	94 %	1.050	TE: 2213407-2 + OPTIC CLIP Z50 TYPE1 2213194-1
PrevaLED Core AC (LEP-800)	40 deg	Wide	93 %	1.260	TE: OPTIC CLIP Z50 TYPE1 2213194-1
PrevaLED Core AC (LEP-2000)	49 deg	Wide	93 %	1.070	TE: OPTIC CLIP Z50 TYPE1 2213194-1
PrevaLED Core Z4 LES19	47 deg	Wide	93 %	1.100	TE: OPTIC CLIP Z50 TYPE1 2213194-1
Soleriq P13	47 deg	Wide	93 %	1.080	TE: 2213401-2 + OPTIC CLIP Z50 TYPE1 2213194-1
Soleriq S13 Gen2	51 deg	Wide	92 %	1.000	TE: 2213254-2 + OPTIC CLIP Z50 TYPE1 2213194-1
Soleriq S13 Gen2	45 deg	Wide	91 %	1.100	IDEAL: 50-2103CT + 50-2100AN
Fortimo SLM 2000 G3	50 deg	Wide	91 %	1.000	TE: OPTIC CLIP Z50 TYPE1 2213194-1
Fortimo SLM 3000 G3	50 deg	Wide	90 %	1.000	TE: OPTIC CLIP Z50 TYPE1 2213194-1
Fortimo SLM 4500 G3	53 deg	Wide	89 %	0.900	TE: OPTIC CLIP Z50 TYPE1 2213194-1
Fortimo SLM 1211 L19 G6 Standard	54 deg	Wide	92 %	0.950	TE: OPTIC CLIP Z50 TYPE1 2213194-1
Fortimo LED SLM L9 G4 standard	38 deg	Wide	92 %	1.200	TE: OPTIC CLIP Z50 TYPE1 2213194-1
Fortimo LED SLM L13 G4 standard	45 deg	Wide	93 %	1.100	TE: OPTIC CLIP Z50 TYPE1 2213194-1
Fortimo LED SLM L15 G4 standard	47 deg	Wide	93 %	1.100	TE: OPTIC CLIP Z50 TYPE1 2213194-1
Fortimo LED SLM L19 G4 standard	52 deg	Wide	92 %	0.970	TE: OPTIC CLIP Z50 TYPE1 2213194-1
Fortimo SLM G5 LES 9 Standard	42 deg	Wide	92 %	1.190	TE: OPTIC CLIP Z50 TYPE1 2213194-1
Fortimo SLM G5 LES 15 Standard	51 deg	Wide	90 %	1.000	TE: OPTIC CLIP Z50 TYPE1 2213194-1
Fortimo SLM G5 LES 19 Standard	54 deg	Wide	89 %	0.920	TE: OPTIC CLIP Z50 TYPE1 2213194-1
Fortimo SLM G5 LES 13 Standard	48 deg	Wide	92 %	1.070	TE: OPTIC CLIP Z50 TYPE1 2213194-1
LC026B/LC040B	51 deg	Wide	92 %	1.000	TE: 2213258-2 + OPTIC CLIP Z50 TYPE1 2213194-1
LC040C	46 deg	Wide	90 %	1.100	TE: 2213382-2 + OPTIC CLIP Z50 TYPE1 2213194-1
MJT COB LES 14.5	54 deg	Wide	92 %	1.000	TE: 2213254-2 + OPTIC CLIP Z50 TYPE1 2213194-1
Mega Zenigata (GW6DME)	47 deg	Wide	92 %	1.100	TE: 2213130-2 + OPTIC CLIP Z50 TYPE1 2213194-1
Mega Zenigata (GW6DME)	43 deg	Wide	93 %	1.180	IDEAL: 50-2100SH + 50-2100AN
STARK SLE G2 LES19	49 deg	Wide	92 %	1.100	TE: OPTIC CLIP Z50 TYPE1 2213194-1
STARK SLE G2 LES23	53 deg	Wide	90 %	1.000	TE: OPTIC CLIP Z50 TYPE1 2213194-1
STARK SLE G2 LES26	54 deg	Wide	89 %	0.900	TE: OPTIC CLIP Z50 TYPE1 2213194-1
STARK SLE G3 LES19	51 deg	Wide	92 %	1.000	TE: OPTIC CLIP Z50 TYPE1 2213194-1
STARK SLE G3 LES23	56 deg	Wide	90 %	0.900	TE: OPTIC CLIP Z50 TYPE1 2213194-1
SLE G4 LES23 H	54 deg	Wide	93 %	0.960	TE: OPTIC CLIP Z50 TYPE1 2213194-1
SLE G4 LES19 H	49 deg	Wide	90 %	1.000	TE: OPTIC CLIP Z50 TYPE1 2213194-1
SLE G5 LES15	50 deg	Wide	92 %	1.030	TE: 2213254-2 + OPTIC CLIP Z50 TYPE1 2213194-1
SLE G5 LES19 H	51 deg	Wide	92 %	1.000	TE: OPTIC CLIP Z50 TYPE1 2213194-1
SLE G5 LES23 H	57 deg	Wide	93 %	0.910	TE: OPTIC CLIP Z50 TYPE1 2213194-1
SLE G6 LES15	sim: 50	Wide	sim: 92 %	sim: 1.100	TE: 2213254-2 + OPTIC CLIP Z50 TYPE1 2213194-1



PRODUCT DATASHEET
ANGELINA series
last update 31/1/2017

SLE G6 LES17

sim: 52

Wide

sim: 89 % sim: 1.060 TE: 2213254-2 + OPTIC CLIP Z50 TYPE1 2213194-1



PRODUCT DATASHEET
ANGELINA series
last update 31/1/2017

WU-M-461

50 deg

Wide

93 %

1.050

TE: OPTIC CLIP Z50 TYPE1 2213194-1



PRODUCT DATASHEET
ANGELINA series
last update 31/1/2017

WU-M-462

55 deg

Wide

93 %

0.940

TE: OPTIC CLIP Z50 TYPE1 2213194-1



PRODUCT DATASHEET
ANGELINA series
last update 31/1/2017

WU-M-464

55 deg

Wide

93 %

0.940

TE: OPTIC CLIP Z50 TYPE1 2213194-1



PRODUCT DATASHEET
ANGELINA series
last update 31/1/2017

WU-M-484

51 deg

Wide

93 %

1.040

TE: OPTIC CLIP Z50 TYPE1 2213194-1



PRODUCT DATASHEET
ANGELINA series
last update 31/1/2017

WU-M-485

57 deg

Wide

93 %

0.920

TE: OPTIC CLIP Z50 TYPE1 2213194-1



PRODUCT DATASHEET
ANGELINA series
last update 31/1/2017

WU-M-486

56 deg

Wide

93 %

0.930

TE: OPTIC CLIP Z50 TYPE1 2213194-1

D

C

B

A

4

4

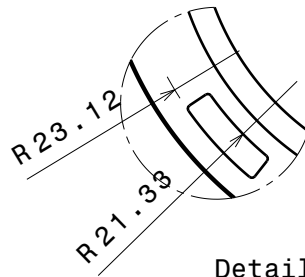
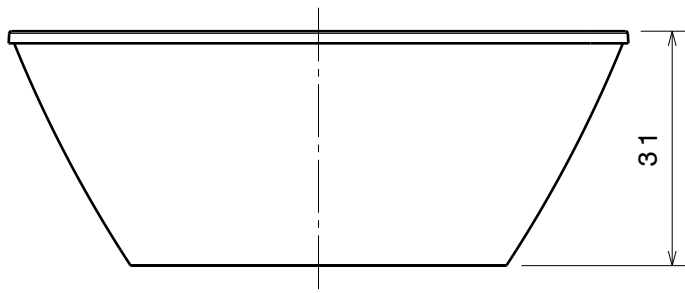

Detail B
Scale: 2:1

3

3

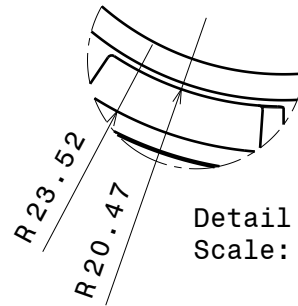
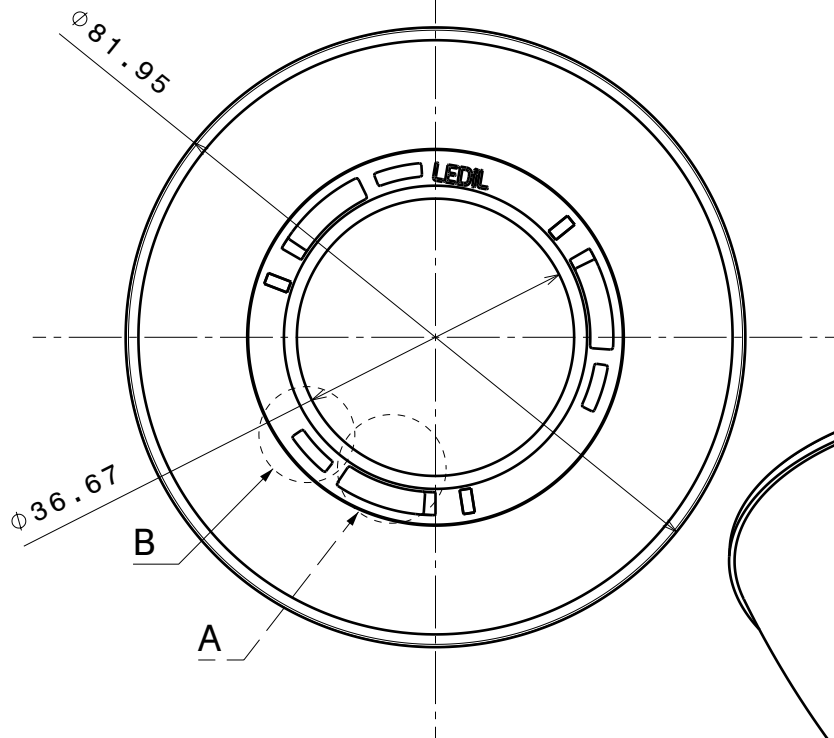

Detail A
Scale: 2:1

2

2

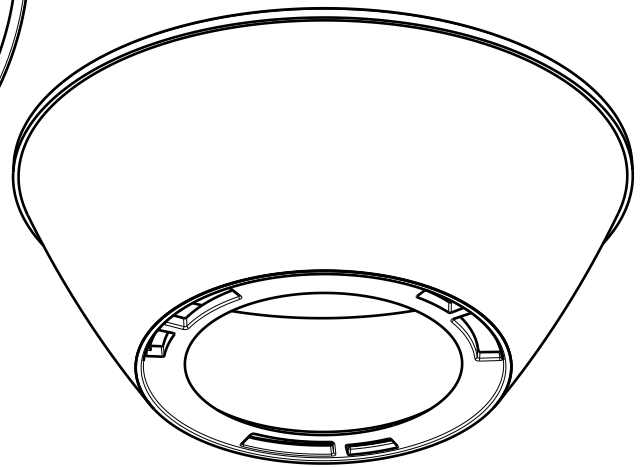

1

1

INDEX	PART NO	DESCRIPTION	MATERIAL	COLOUR
1		ANGELINA	PC	metal

Tolerances if not otherwise shown
According to DIN ISO 2768-1
Linear measures:
Up to 30mm class M, otherwise class C.
According to DIN ISO 2768-2
Form and position: class L

LEDiL
LediL Oy
Salorankatu 10
FIN 24240 SALO
Finland

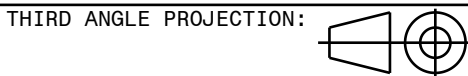

DRAWING TITLE
ANGELINA series Reflector

This drawing is the property of LEDiL Oy. It may not be reproduced, copied or communicated without a written agreement with LEDiL Oy."

SIZE	PART NUMBER
A4	-

SCALE	1:1	WEIGHT	-	SHEET	1/1
-------	-----	--------	---	-------	-----

D

A

Luminaire: LEDiL Oy F13402_ANGELINA-W_(MEGAZENIGATA) Eff.93.0%
Lamps: 1 x SHARP_MEGAZENIGATA_(GW6DME30NFC)_1238.26lm@250mA_CCT=3000K_P=11.1211W_I=249.8mA

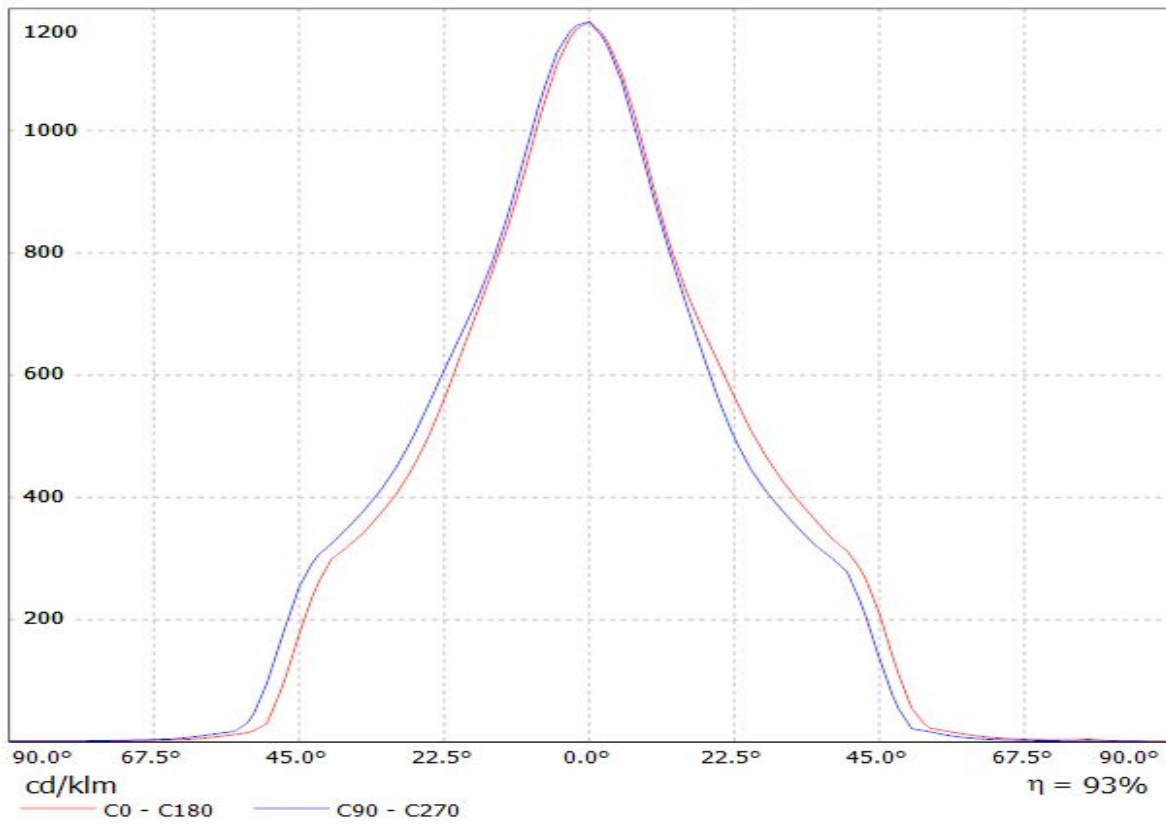

Luminaire: Ledil F13402_ANGELINA-W_(V22+IDEAL)
Lamps: 1 x Bridgelux_V22_(BXRE30E6500H-Y2)_+50-2204CT+_50-2100AN_1193.54lm@250mA_CCT=3000K_P=8.0988W_I=0.25A

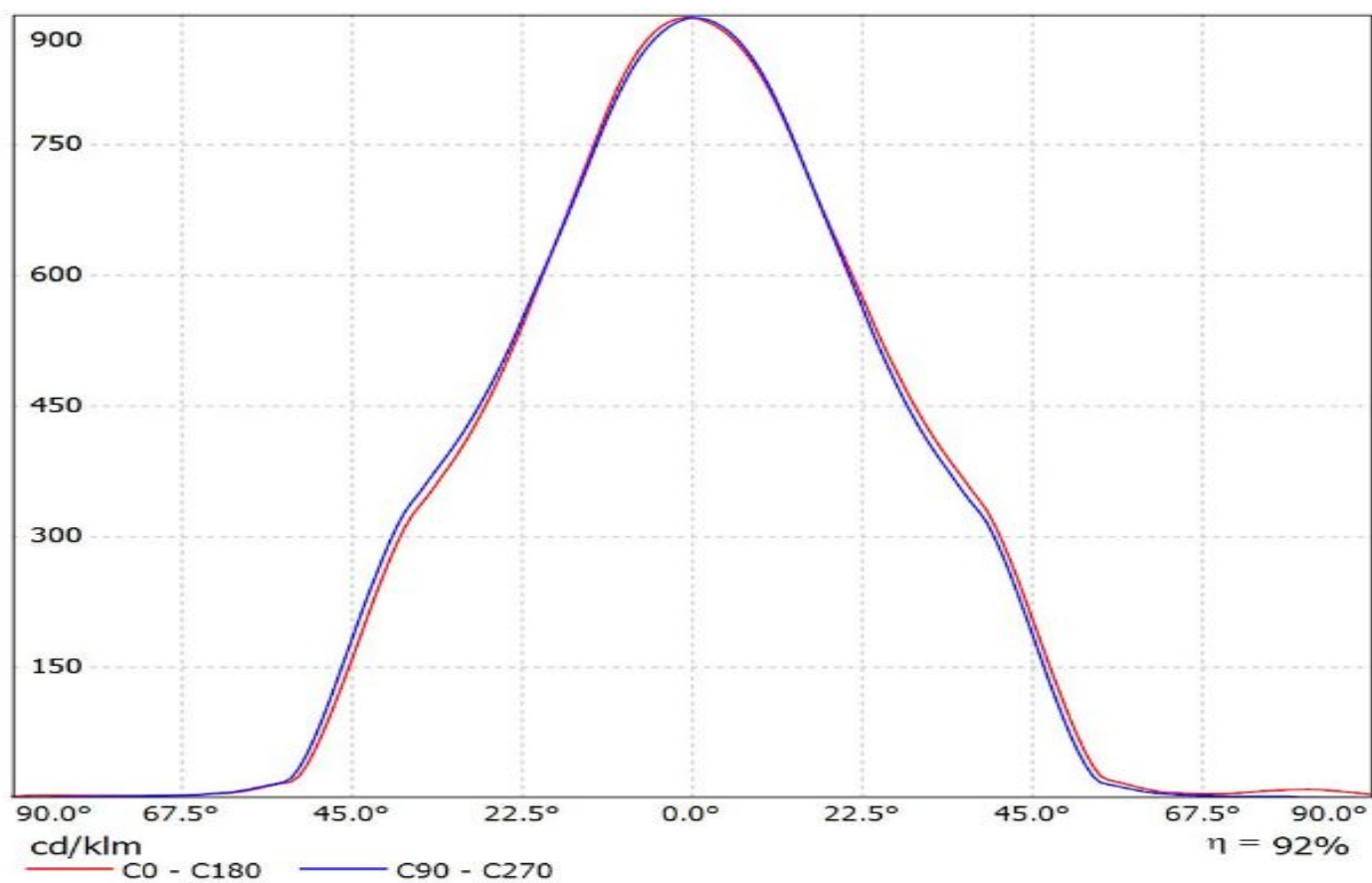

Luminaire: LEDiL Oy F13402_ANGELINA-W (V13_Gen7)+TE

Lamps: 1 x Bridgelux_V13_Gen7_(BXRE-30E2000-B_+TE_2213254-2+TE_2213194-1)_1295.55lm@250mA_P=8.30985W_I=0.25A

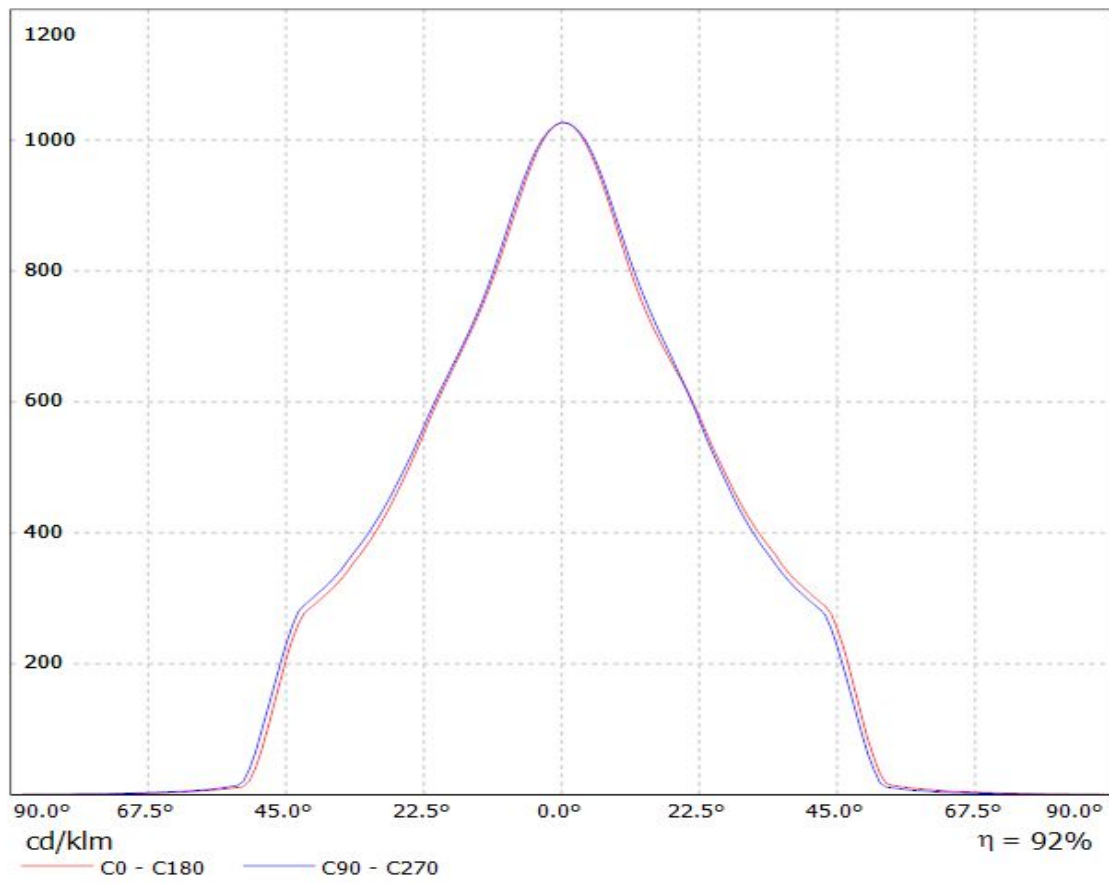

Luminaire: Ledil Oy F13402_ANGELINA-W_Bridgelux_V22_Gen7_SIMULATED F13402_ANGELINA-W_Bridgelux_V22_Gen7_SIMULATED
Lamps: 1 x F13402_ANGELINA-W_Bridgelux_V22_Gen7_SIMULATED

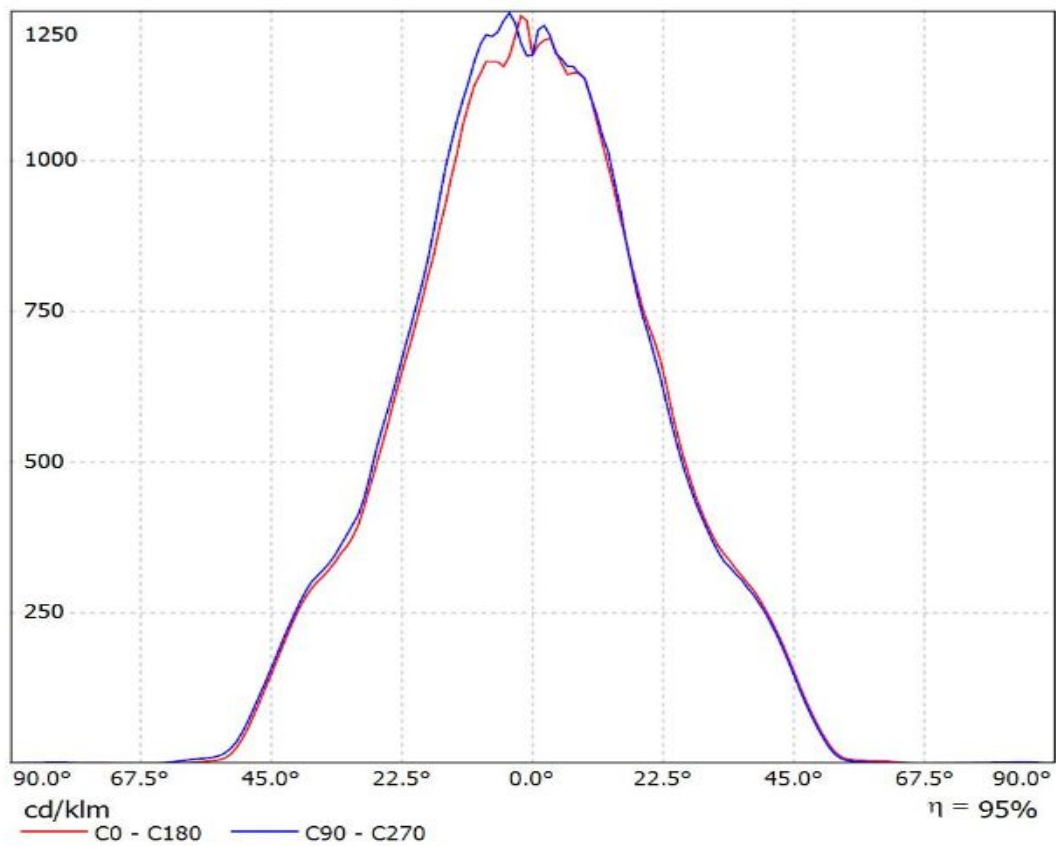

Luminaire: LEDiL Oy F13402_ANGELINA-W_(CLL030) Eff 92.6%

Lamps: 1 x CITIZEN_CLL030_(CLL030-1205A5-303H1A7)_758.588lm@250mA_CCT=5090K_P=8.61086W_I=249.8mA

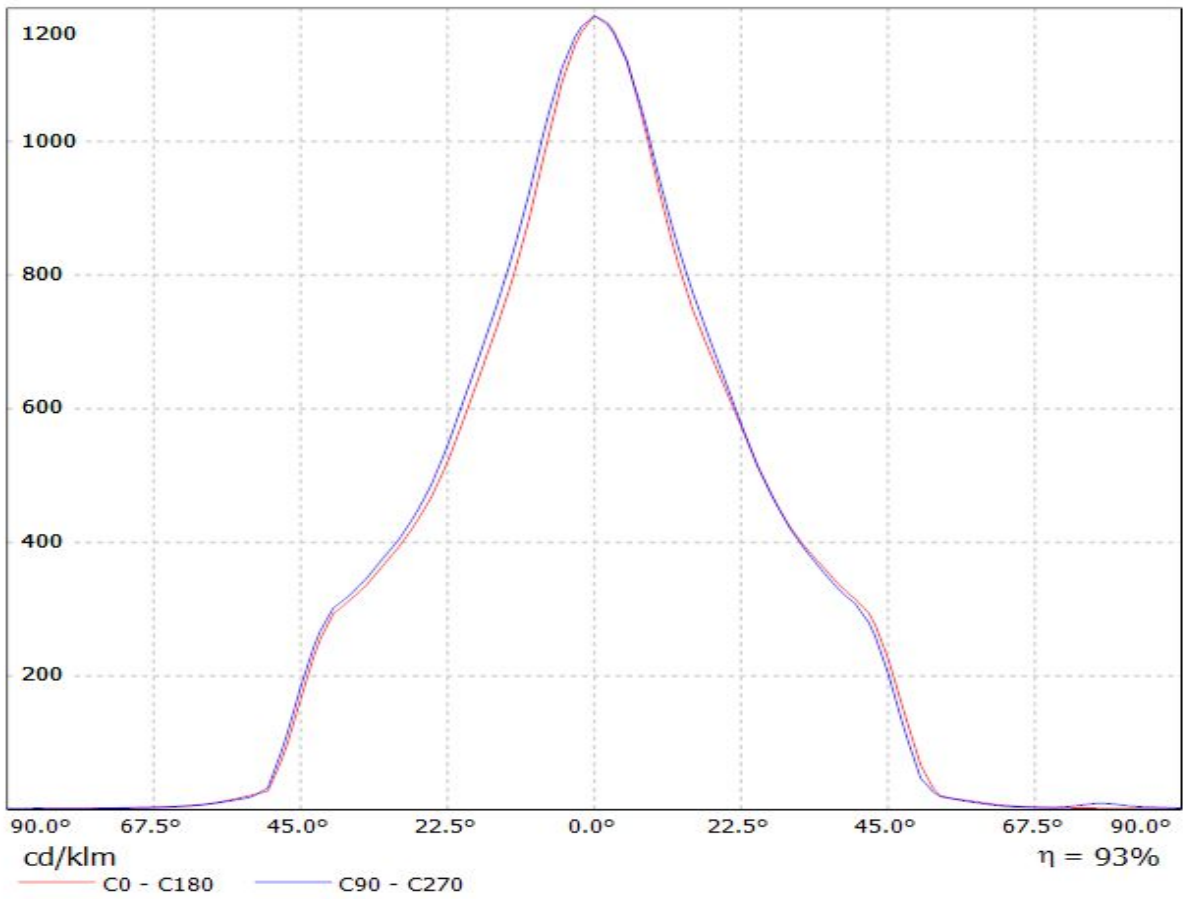

Luminaire: LEDiL F13402_ANGELINA-W

Lamps: 1 x CLL030 740lm@250mA (CLL030-1205A5-303H1A7) CCT:3000K P:8.6W

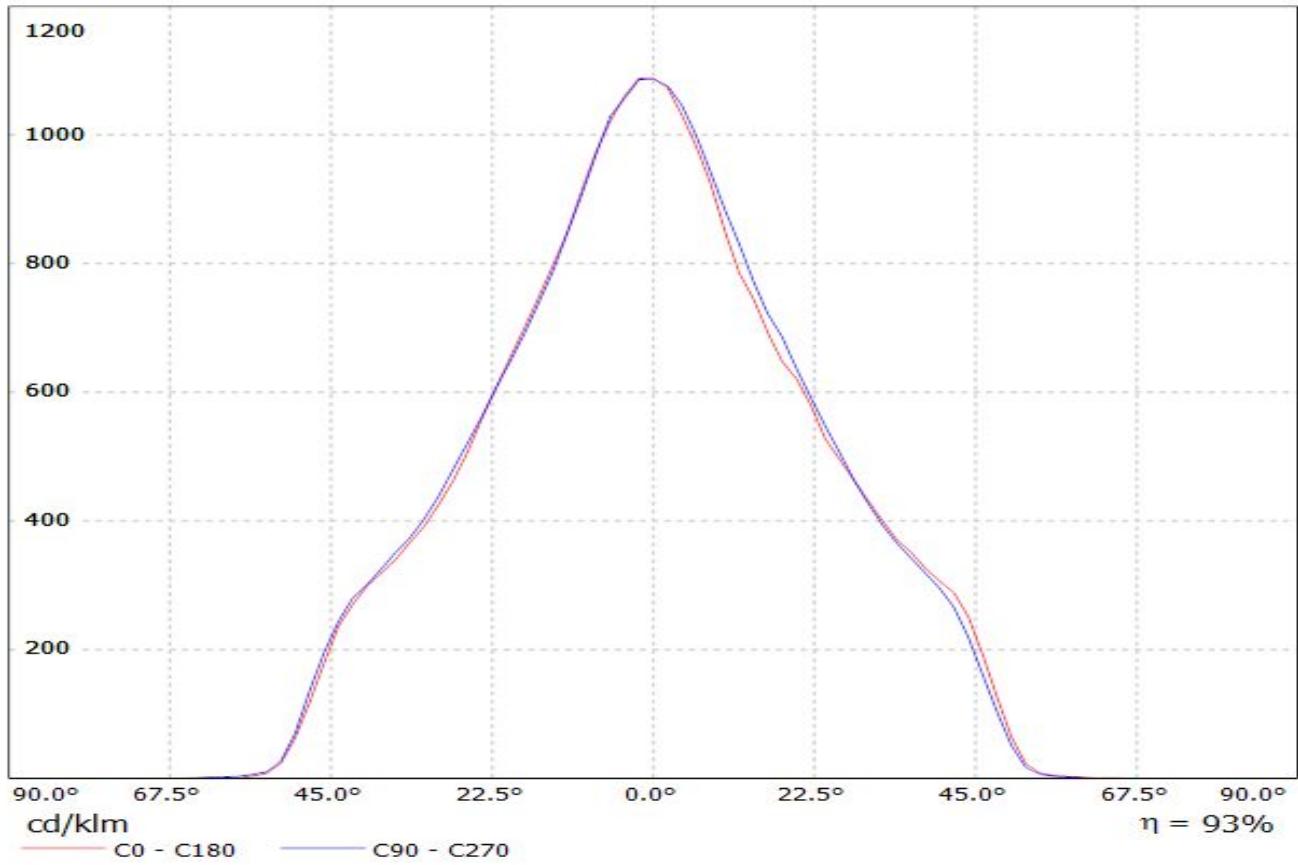

Luminaire: Ledil F13402_ANGELINA-W_(CLU720)
Lamps: 1 x CITIZEN_CLU720_(CLU720-1206B8-273M2)
_1337.27lm@250mA_CCT=2700K_P=8.35W_I=0.25A

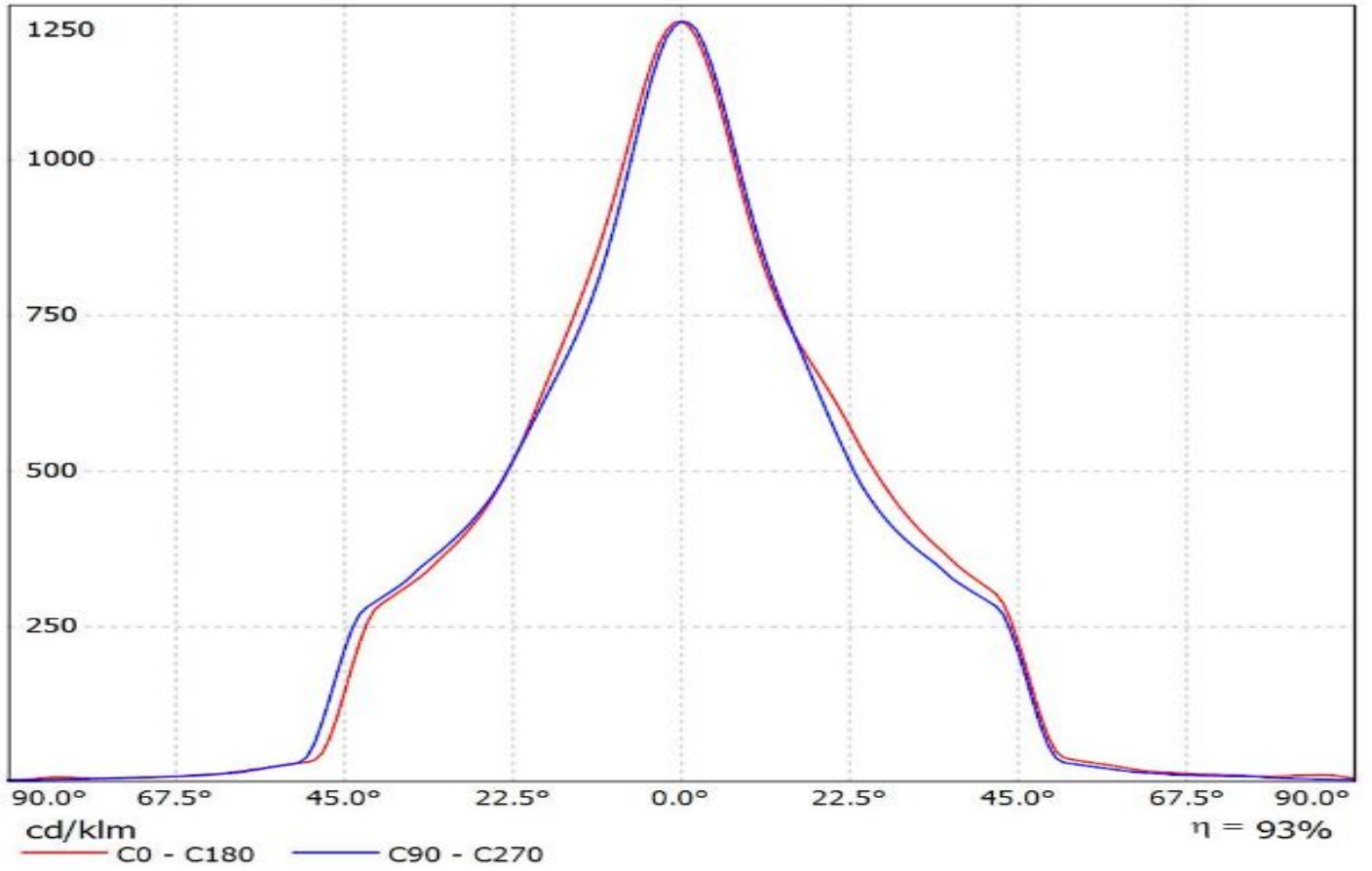

Ledil F13402_ANGELINA-W_(CLU720) / LDC (Linear)

Luminaire: Ledil F13402_ANGELINA-W_(CLU720)
Lamps: 1 x CITIZEN_CLU720_(CLU720-1206B8-273M2)
_1340.38lm@250mA_CCT=2700K_P=8.35W_I=0.25A

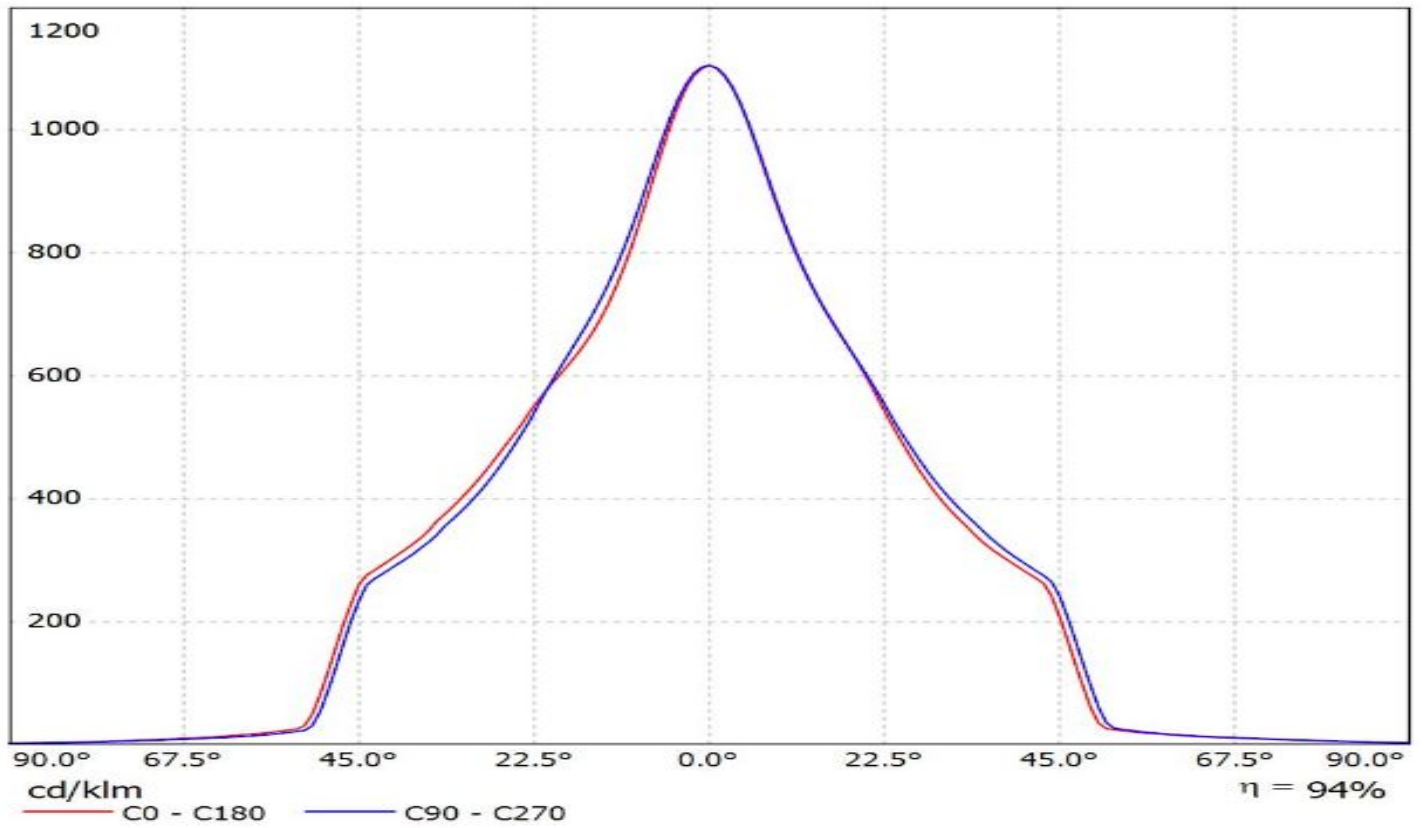

Luminaire: Ledil F13402_ANGELINA-W_(CLU046+IDEAL)

Lamps: 1 x Citizen_CLU046_(-1212C1-303M2G2)_1383.92lm@250mA_CCT=3000K_P=8.122W_I=0.25A

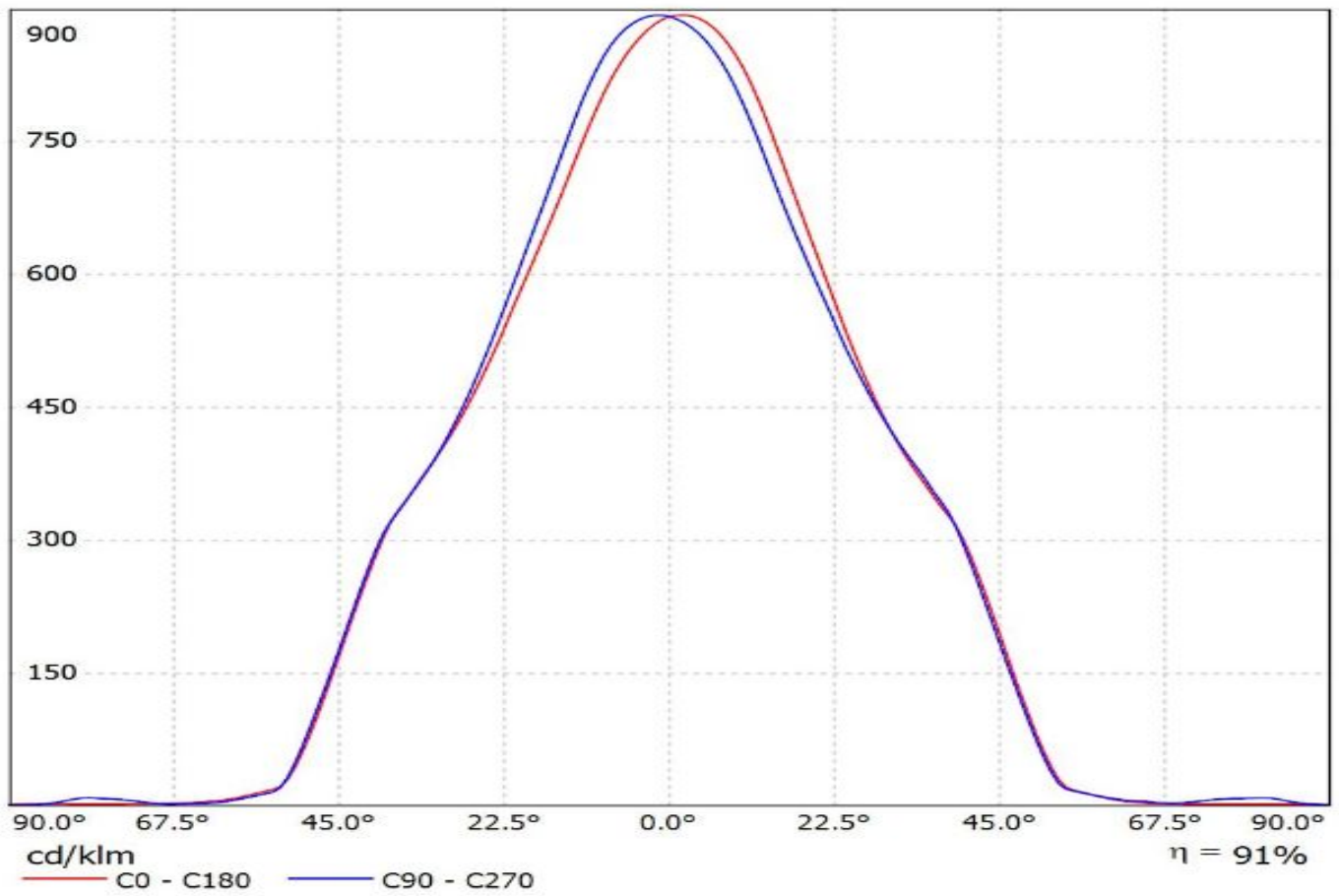

Luminaire: Ledil F13402_ANGELINA-W_(CLU730+IDEAL)

Lamps: 1 x Citizen_CLU730_(-1210B8-273M2G1)_IDEAL_50-2204C+50-2100AN

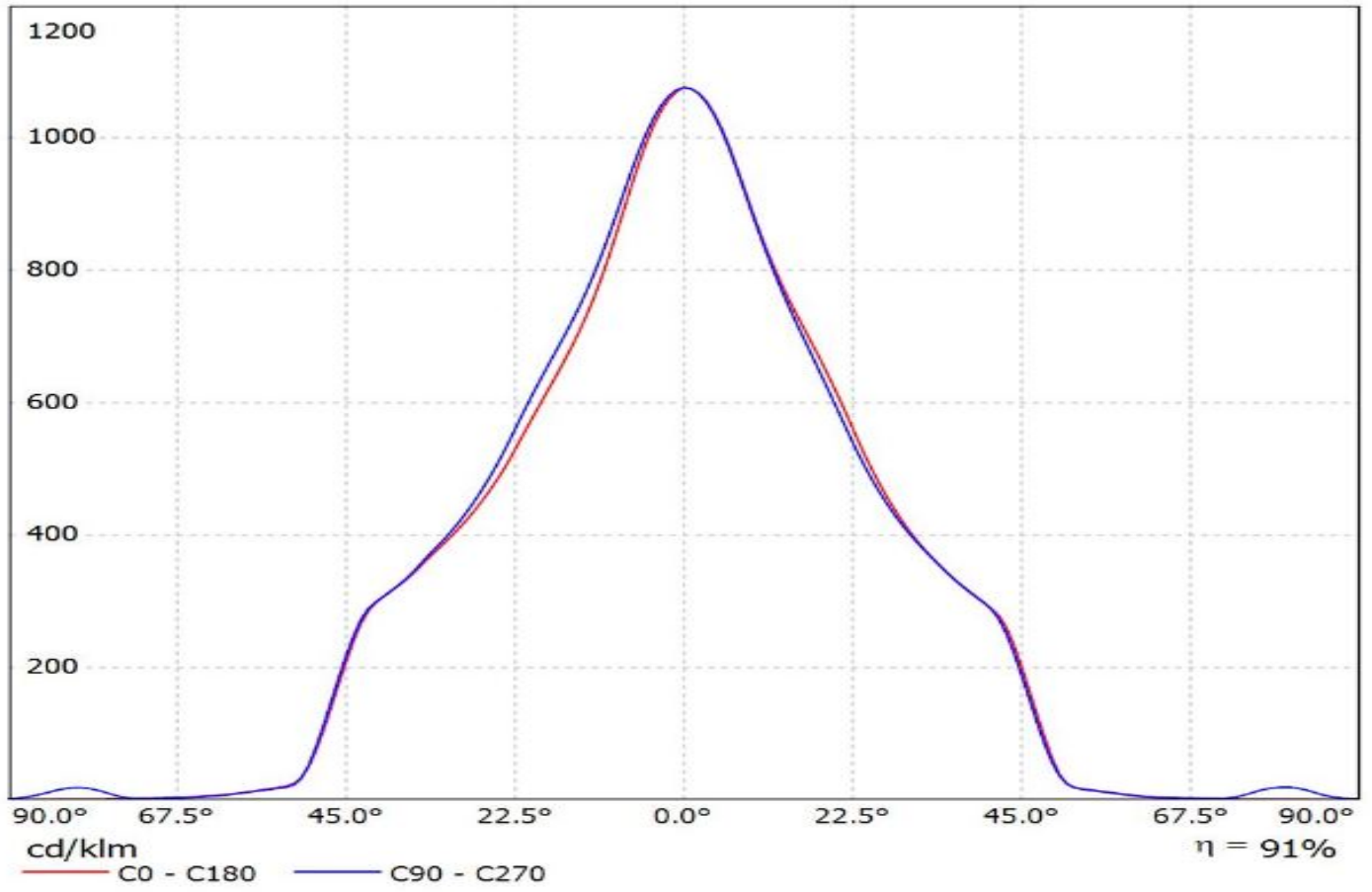

Luminaire: LEDiL Oy F13402_ANGELINA-W_(CXA25) Eff.93.9%
Lamps: 1 x CREE_CXA25_(CXA2530-7C0-T2-N0H)_1151.98lm@250mA_CCT=3000K_P=8.4892W_I=249.8mA

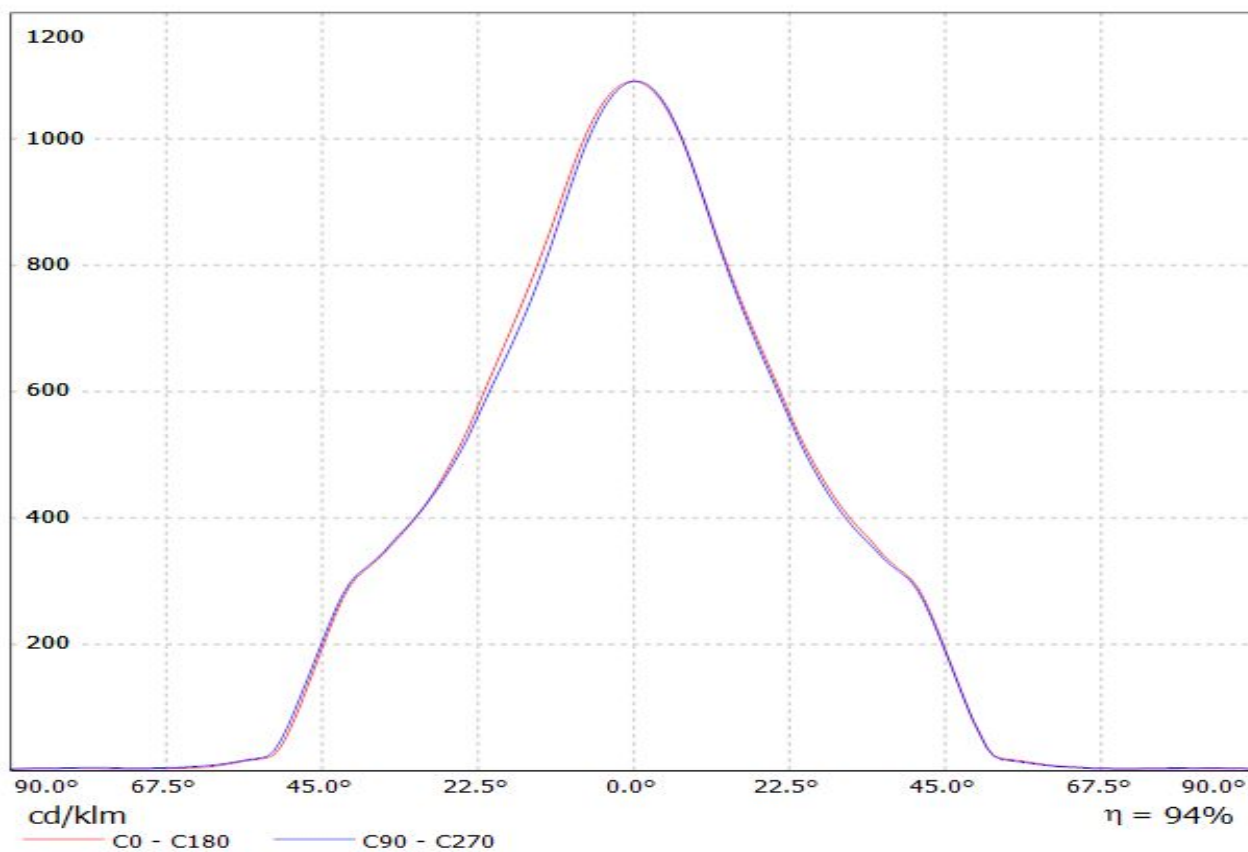

Luminaire: LEDiL Oy F13402_ANGELINA-W_(CXA30) Eff. 93%
Lamps: 1 x CREE_CXA30_(CXA3050-3C0-Y2-N0H)_1340.66lm@250mA_P=8.16471W_CCT=5000K_I=249.8mA

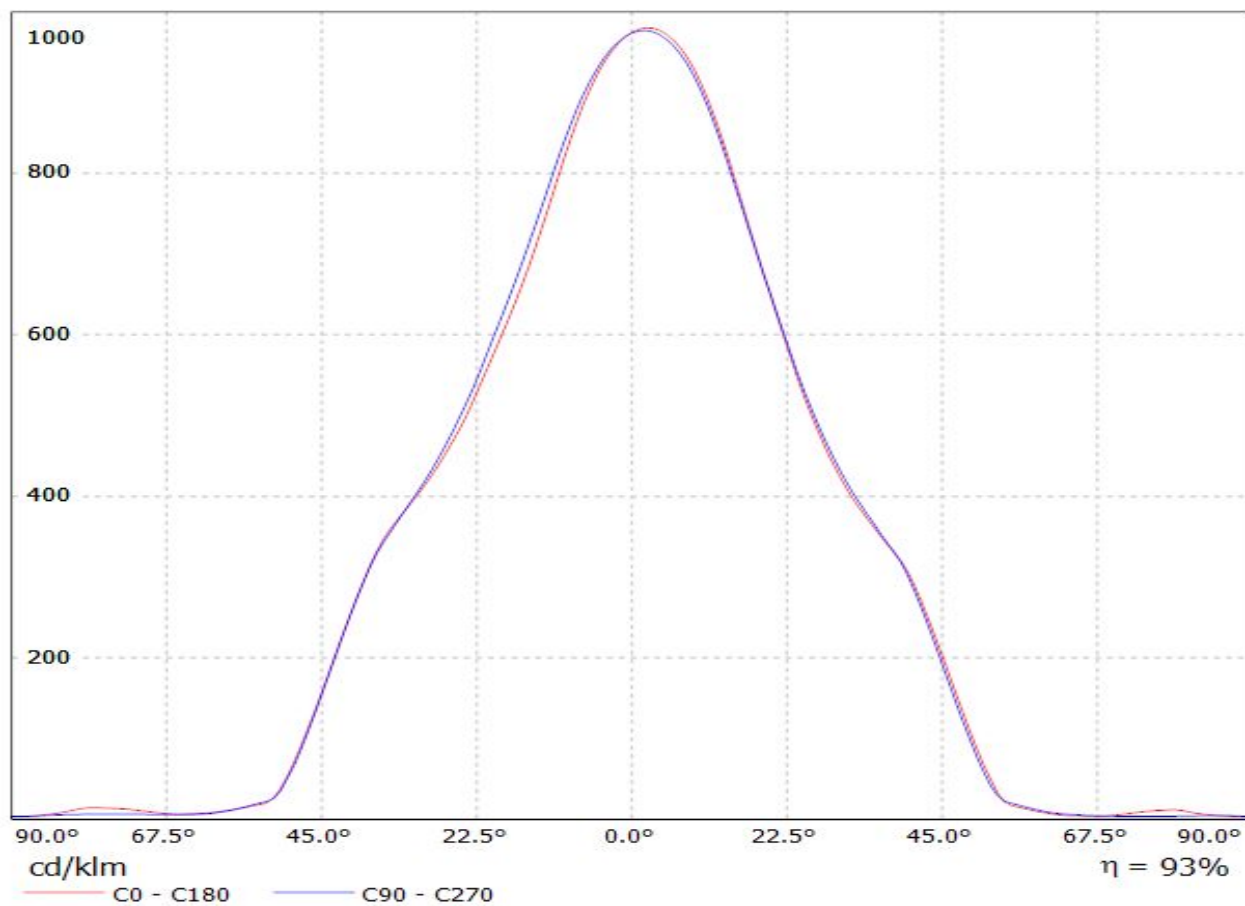

Luminaire: LEDiL Oy F13402_ANGELINA-W_(CXA1816) Eff. 94%
Lamps: 1 x CREE_CXA1816_1042.78lm@250mA_P=8.65157W_I=249.9mA

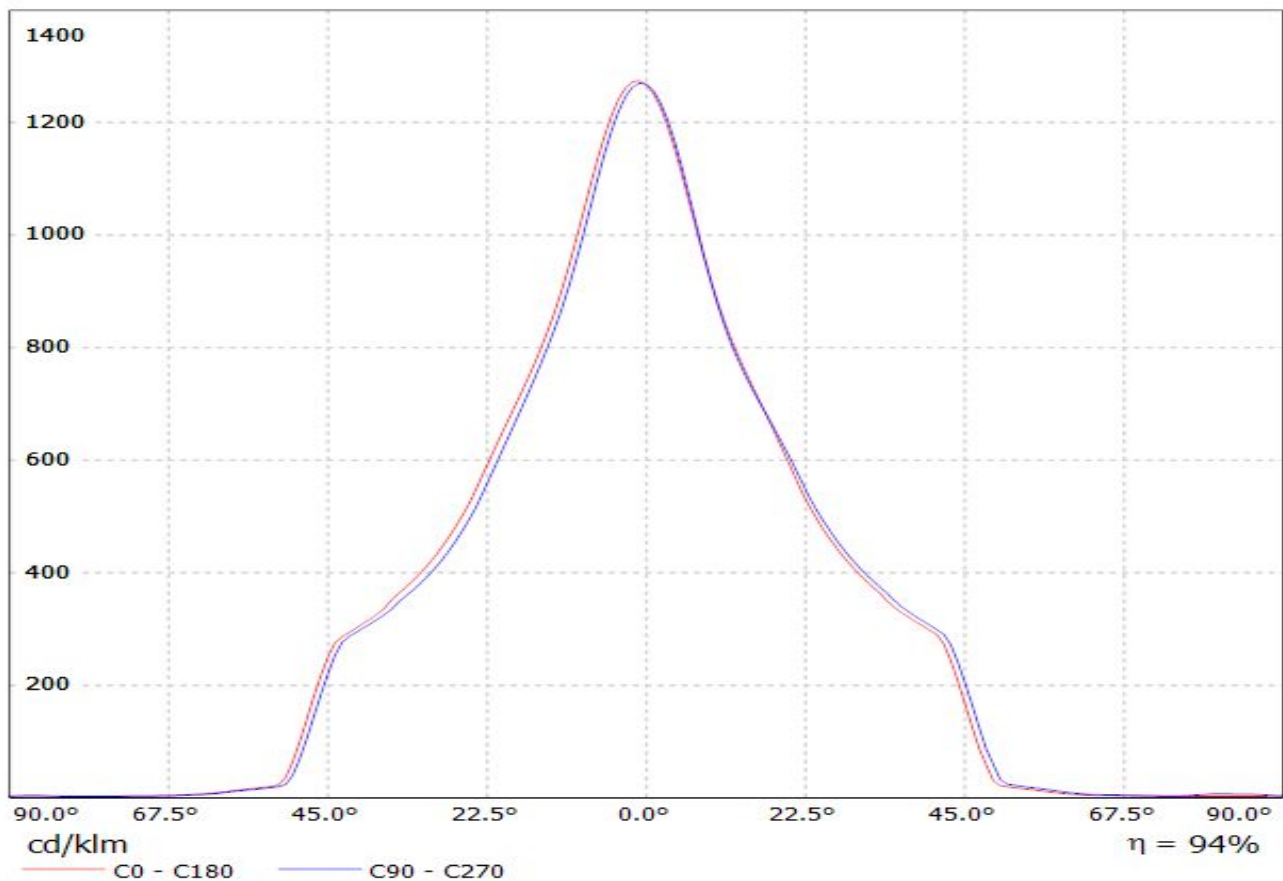

Luminaire: LEDiL Oy F13402_ANGELINA-W_(CXA3590)

Lamps: 1 x CREE_CXA3590_(CXA3590-30F-BD-R0H-0002)_2640.14lm@250mA_CCT=3000K_P=16.3941W_I=249.8mA

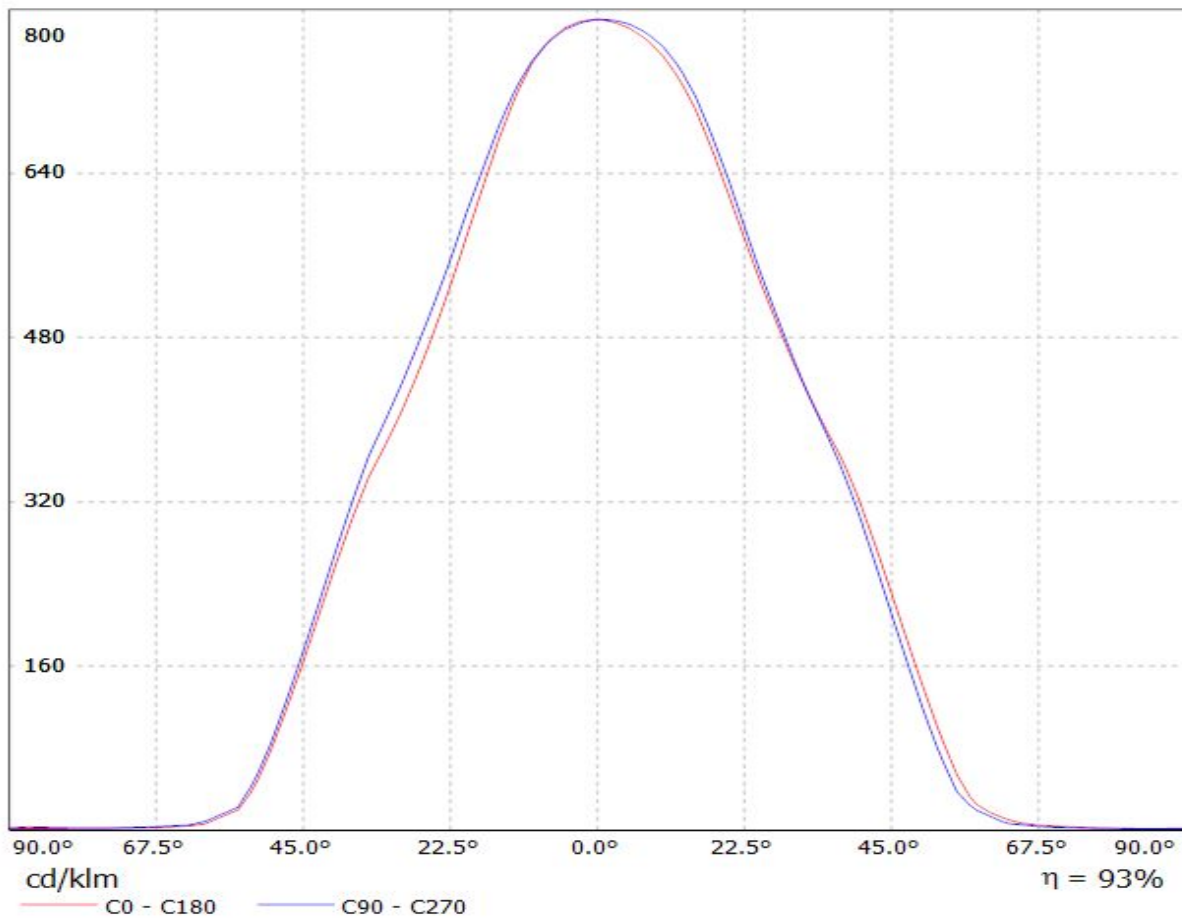

Luminaire: LEDiL Oy F13402_ANGELINA-W_(LG_COB-10W) Eff.93.1%
Lamps: 1 x LG_COB-10W_1024lm@250mA_CCT=5090K_P=9W_I=250mA

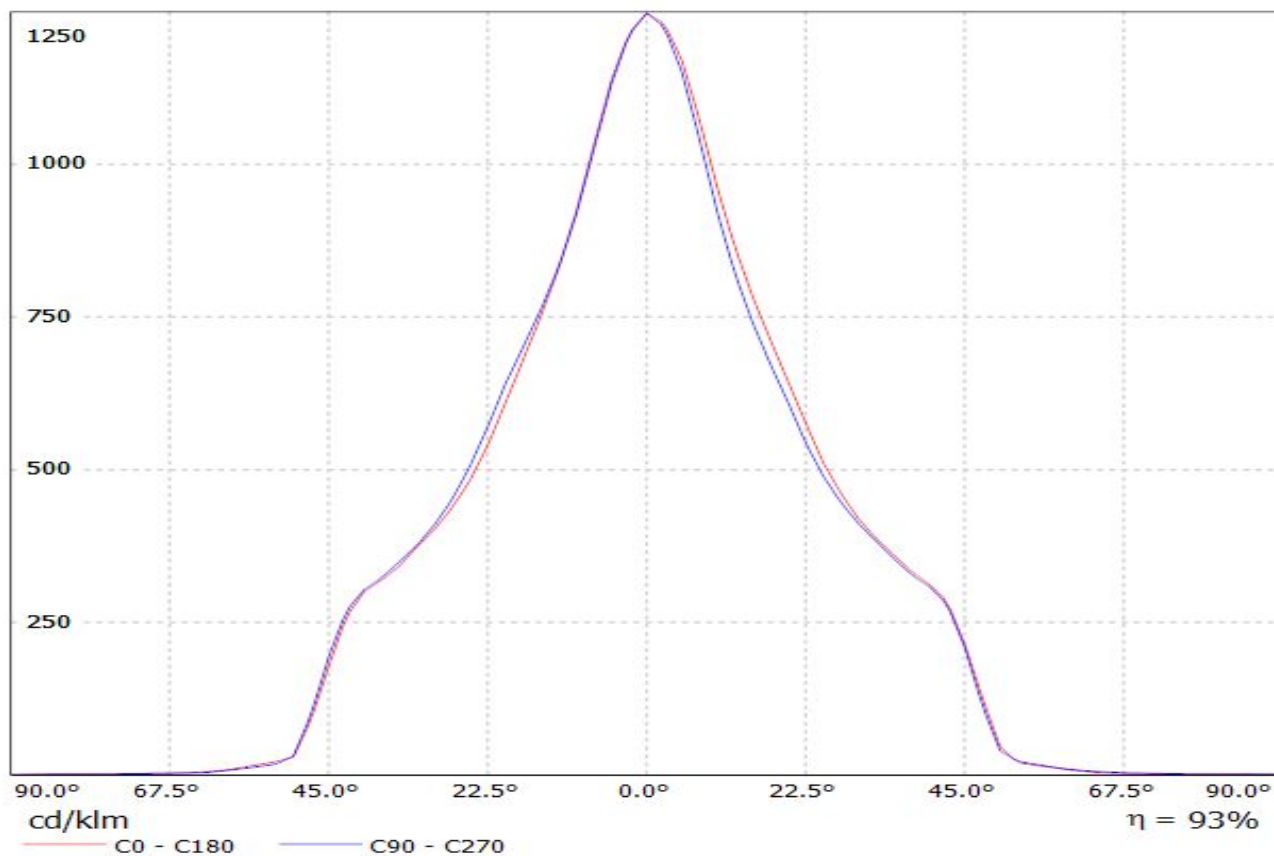

LEDiL Oy C13402_ANGELINA-W_(LUXEON_K16) Eff.93.7% / LDC (Linear)

Luminaire: LEDiL Oy C13402_ANGELINA-W_(LUXEON_K16) Eff.93.7%
Lamps: 1 x LUXEON_K16 (1204.33lm@250mA)

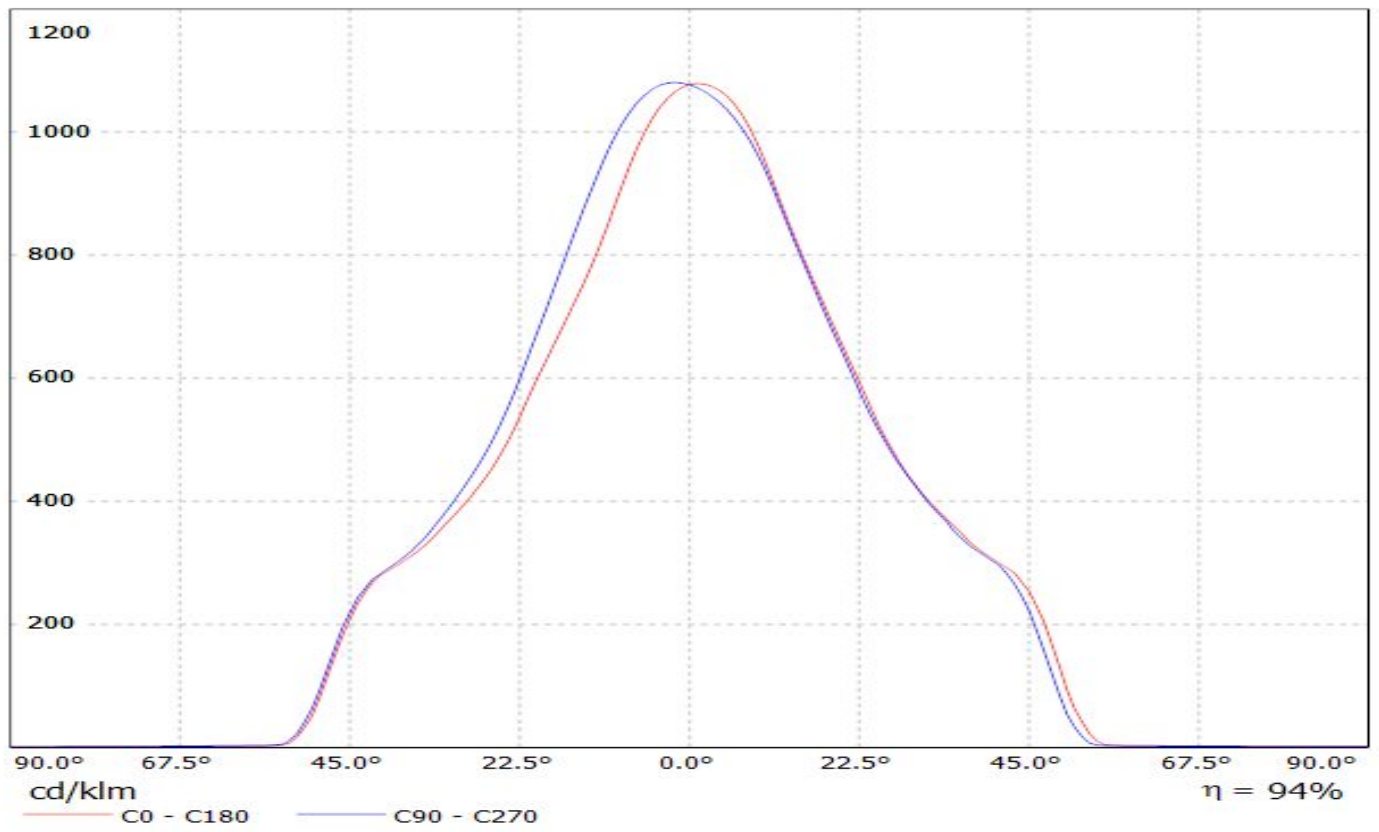

LEDiL Oy C13402_ANGELINA-W_(LUXEON_K12) Eff.94.0% / LDC (Linear)

Luminaire: LEDiL Oy C13402_ANGELINA-W_(LUXEON_K12) Eff.94.0%
Lamps: 1 x LUXEON_K12 (929.543lm@250mA)

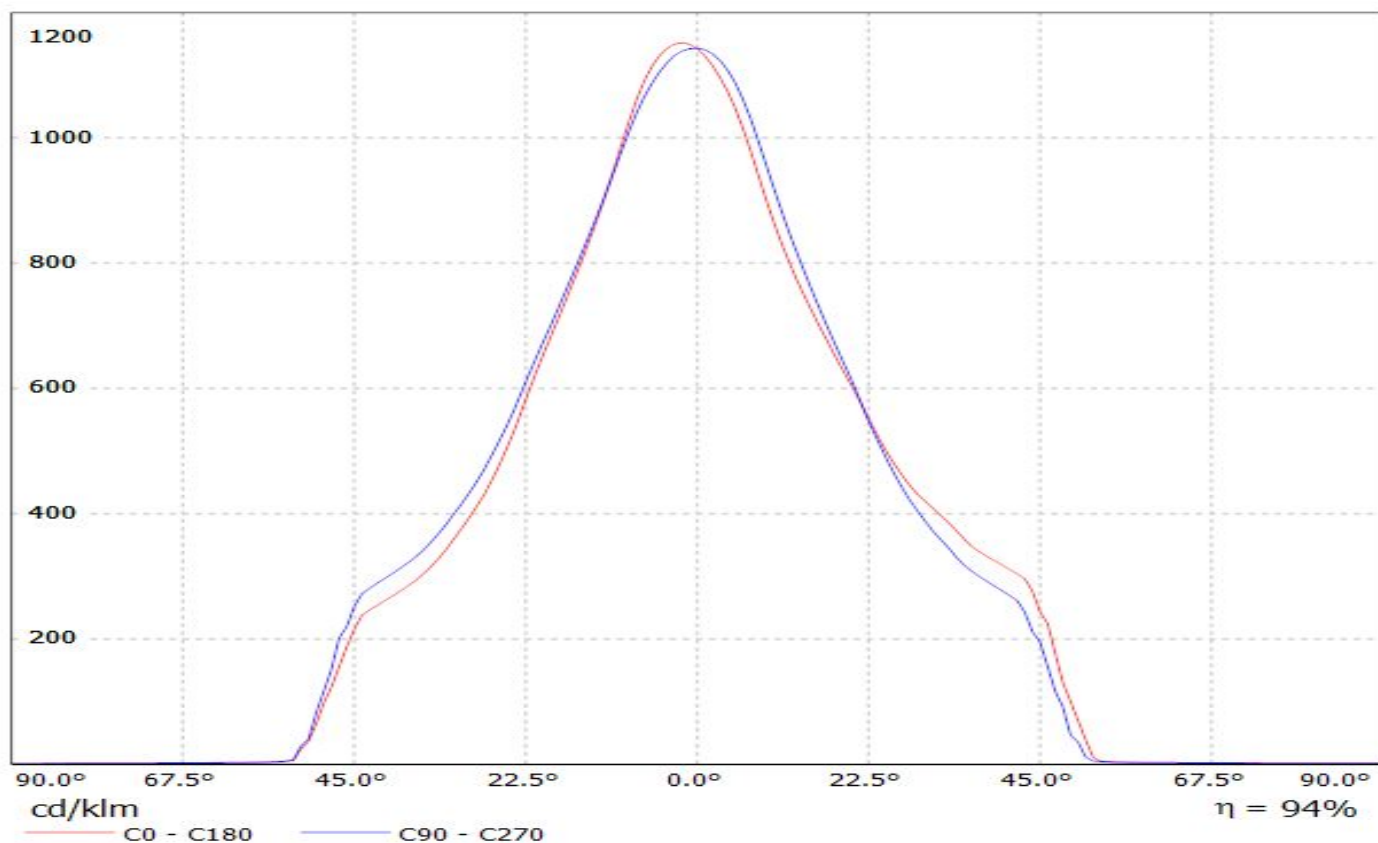

Luminaire: LEDiL Oy F13402_ANGELINA-W_(LUXEON_CoB_1205) Eff: 94 %
Lamps: 1 x LUXEON CoB 1205 (LHC1-3080-1205) 1082lm@250mA CCT=3000K P=8.3W I=250mA

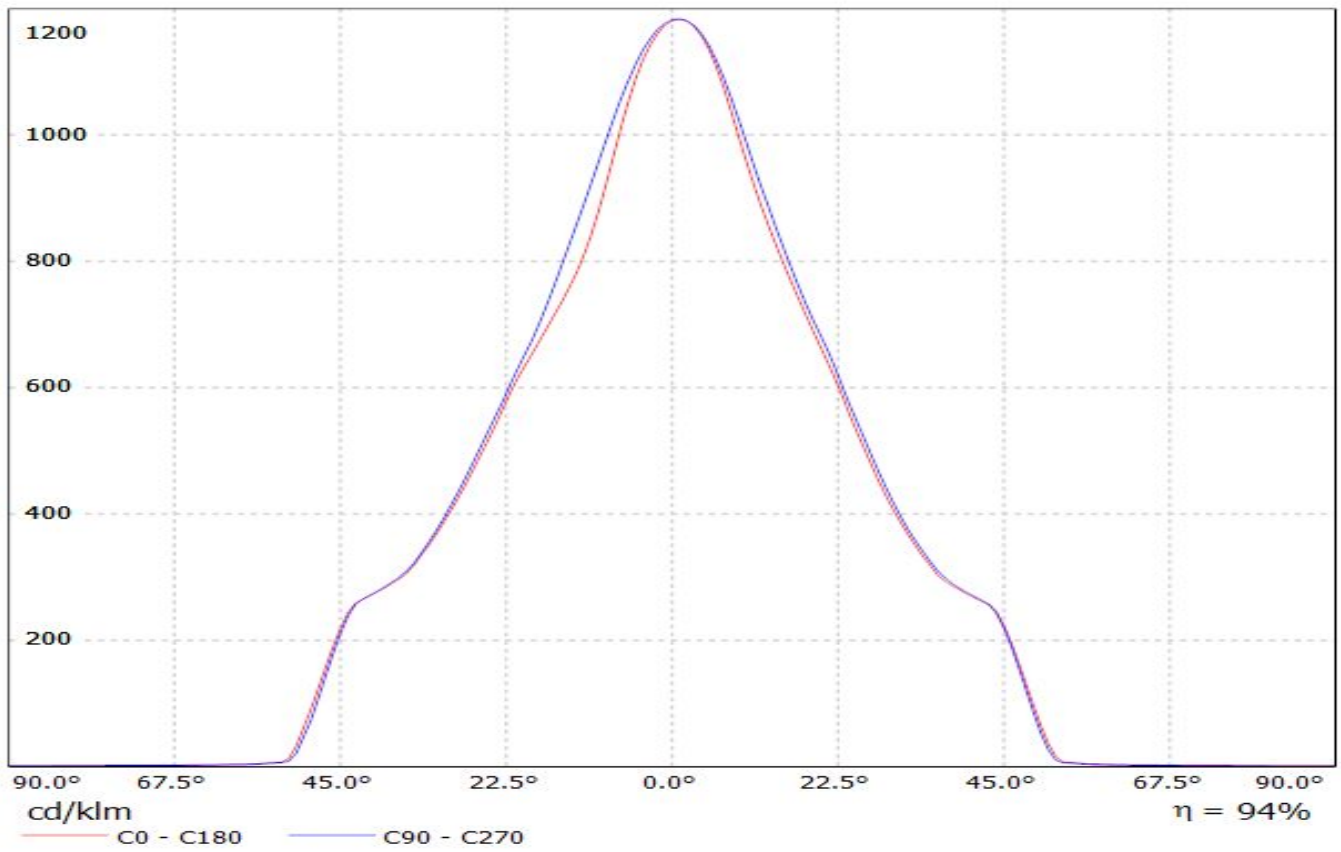

Luminaire: LEDiL Oy F13402_ANGELINA-W_(Luxeon-CoB-1208) Eff: 93 %
Lamps: 1 x Luxeon CoB 1208 (LHC1-3080-1208) 1029lm@250mA CCT=3000K P=8.2W I=250mA

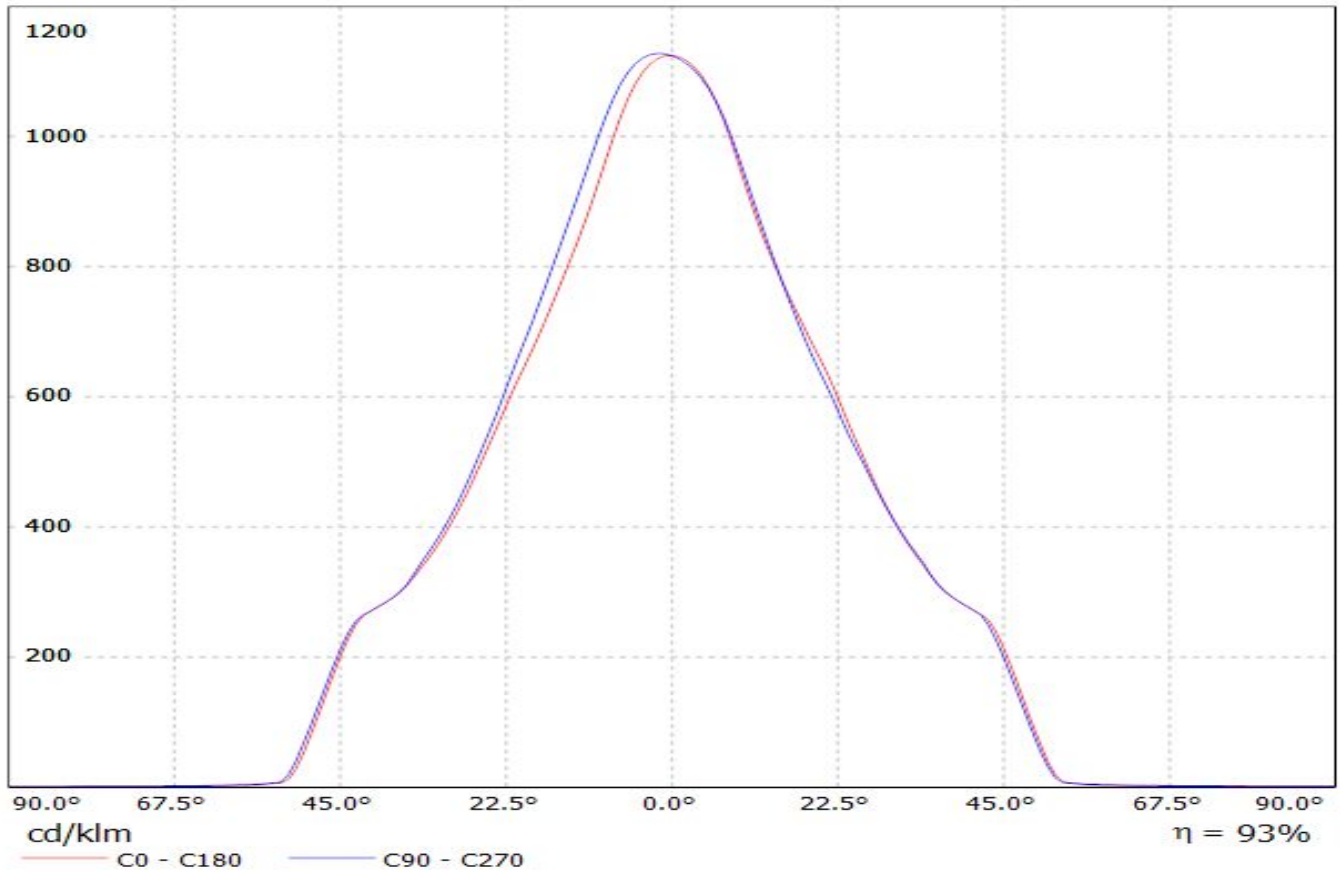

Luminaire: LEDiL Oy F13402_ANGELINA-W_(LUXEON_COB_1205) Eff.93.0%
Lamps: 1 x LUXEON_COB_1205_(LHC1-3080-1205)_1084.49lm@250mA_CCT=3000K_P=8.31784W_I=249.8mA

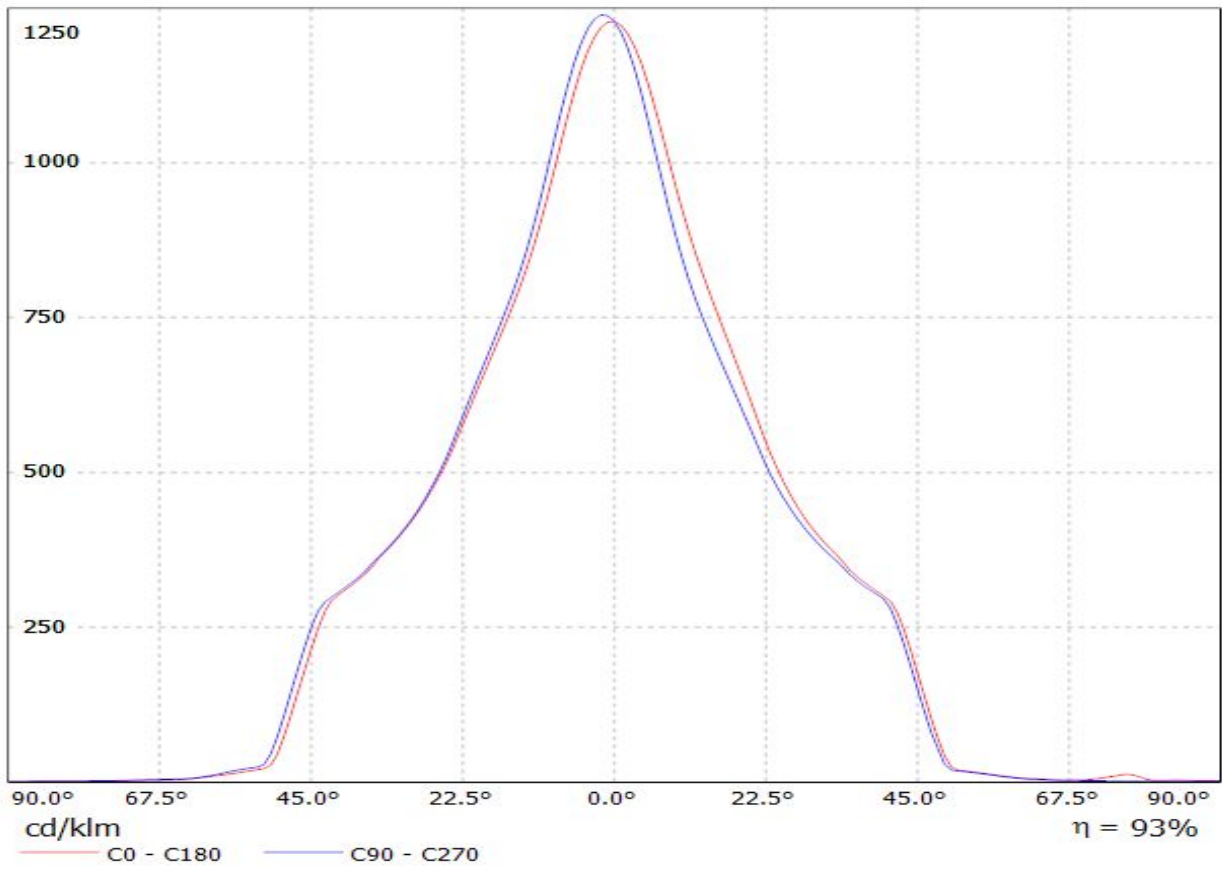

Luminaire: LEDiL Oy F13402_ANGELINA-W_(LUXEON_COB_1208) Eff 93.3%
Lamps: 1 x LUXEON_COB_1208_(LHC1-3080-1208)_1015.13lm@250mA_CCT=3000K_P=8.15972W_I=249.8mA

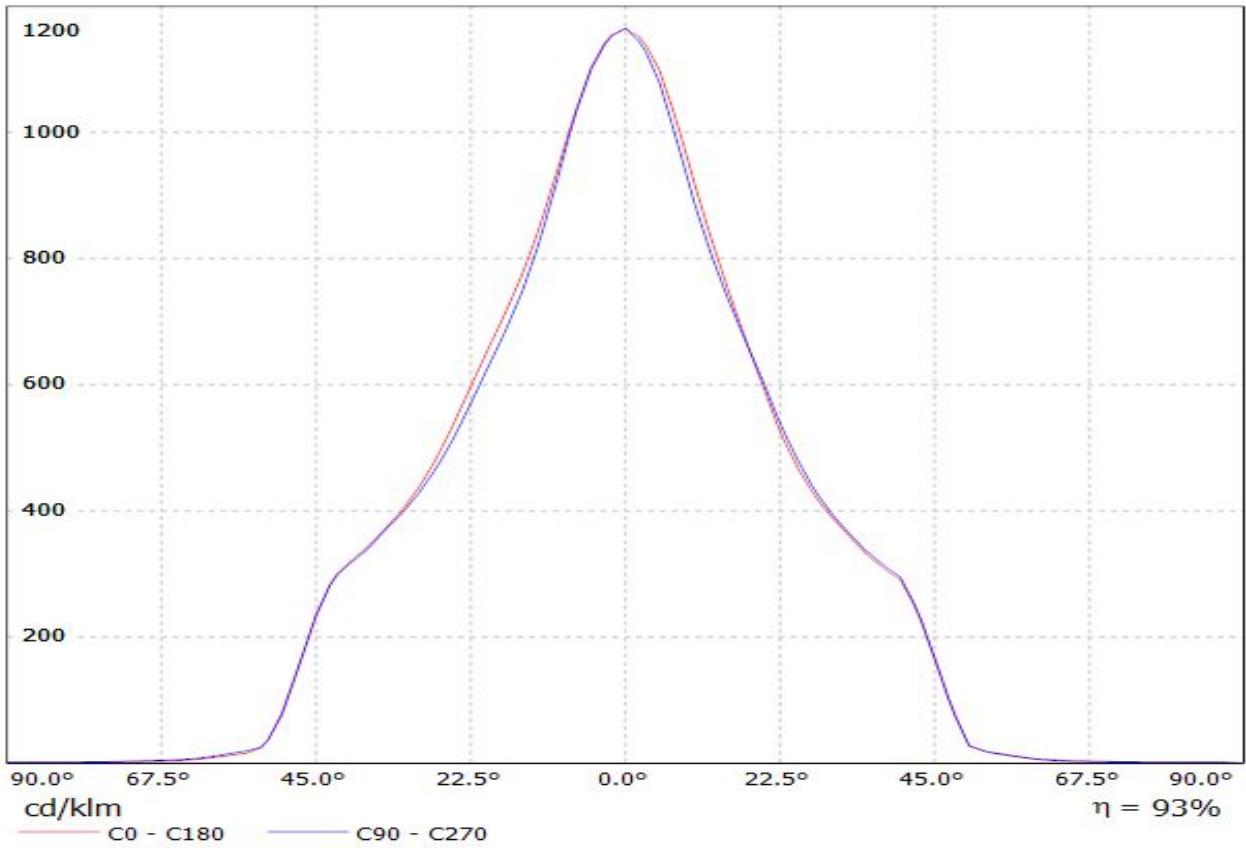

Luminaire: Ledil F13402_ANGELINA-W_(CoB1211+IDEAL)
Lamps: 1 x Luxeon_CoB1211_(L2C2-4080)_50-2204CT+50-2100AN_1376.18lm@250mA_P=7.9988W_I=0.25A

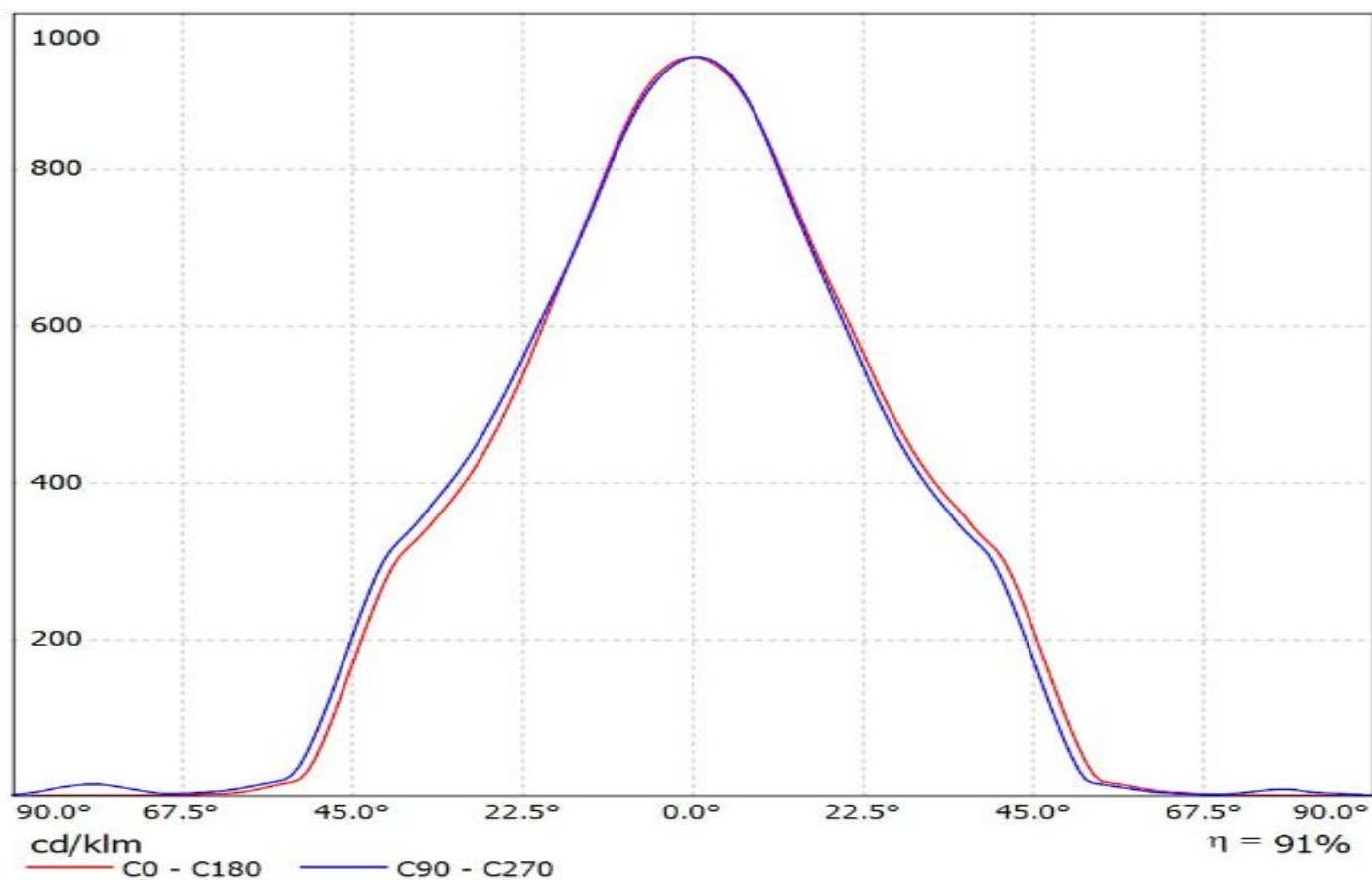

Luminaire: LEDiL Oy F13402_ANGELINA-W_(CXM-14)
Lamps: 1 x LUMINUS_CXM-14_1114.36lm@250mA_P=8.36106W_I=249.8mA

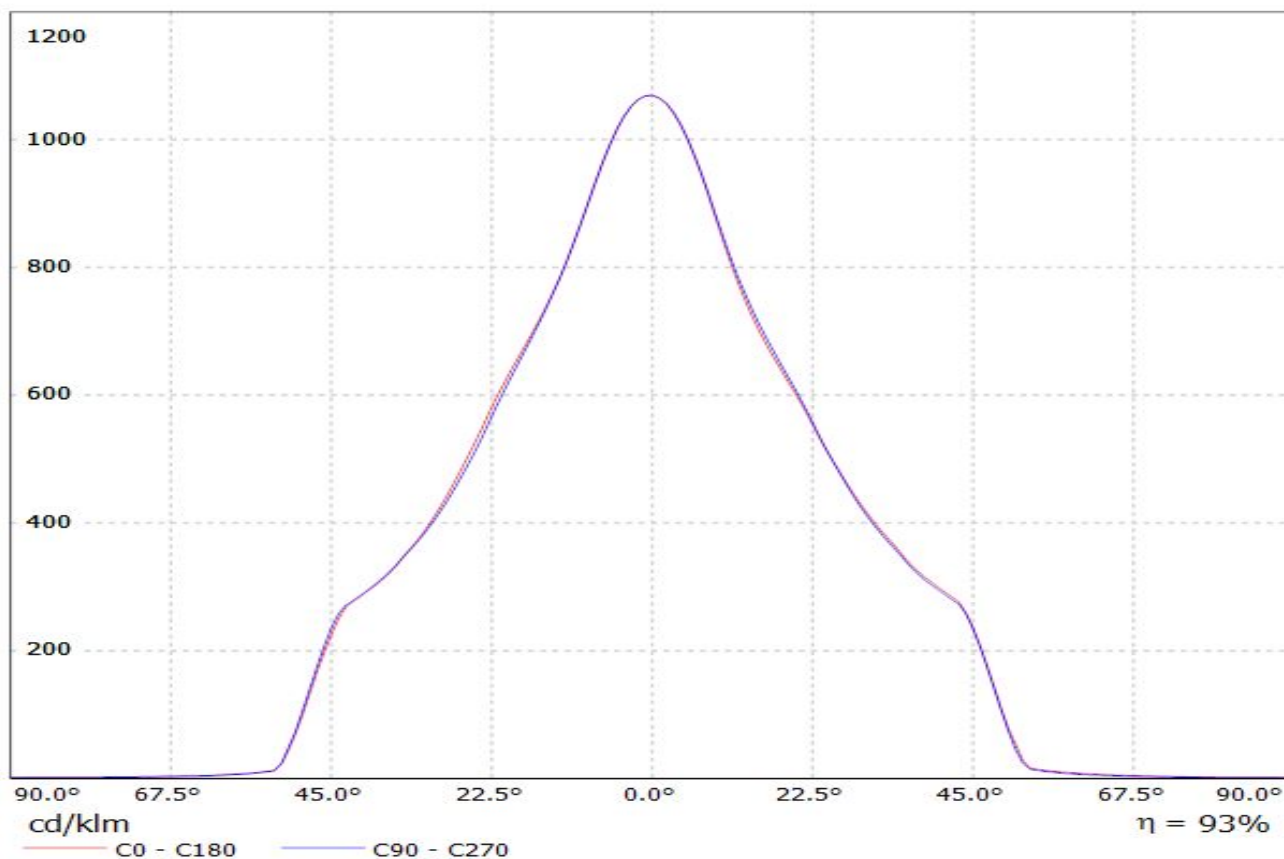

Luminaire: LEDiL Oy F13402_ANGELINA-W_(NSCxJ216A) Eff.93.9%
Lamps: 1 x NICHIA_NSCxJ216A_(NSCLJ216AE)_949.847lm@250mA_CCT=3000K_P=7.96937W_I=249.8mA

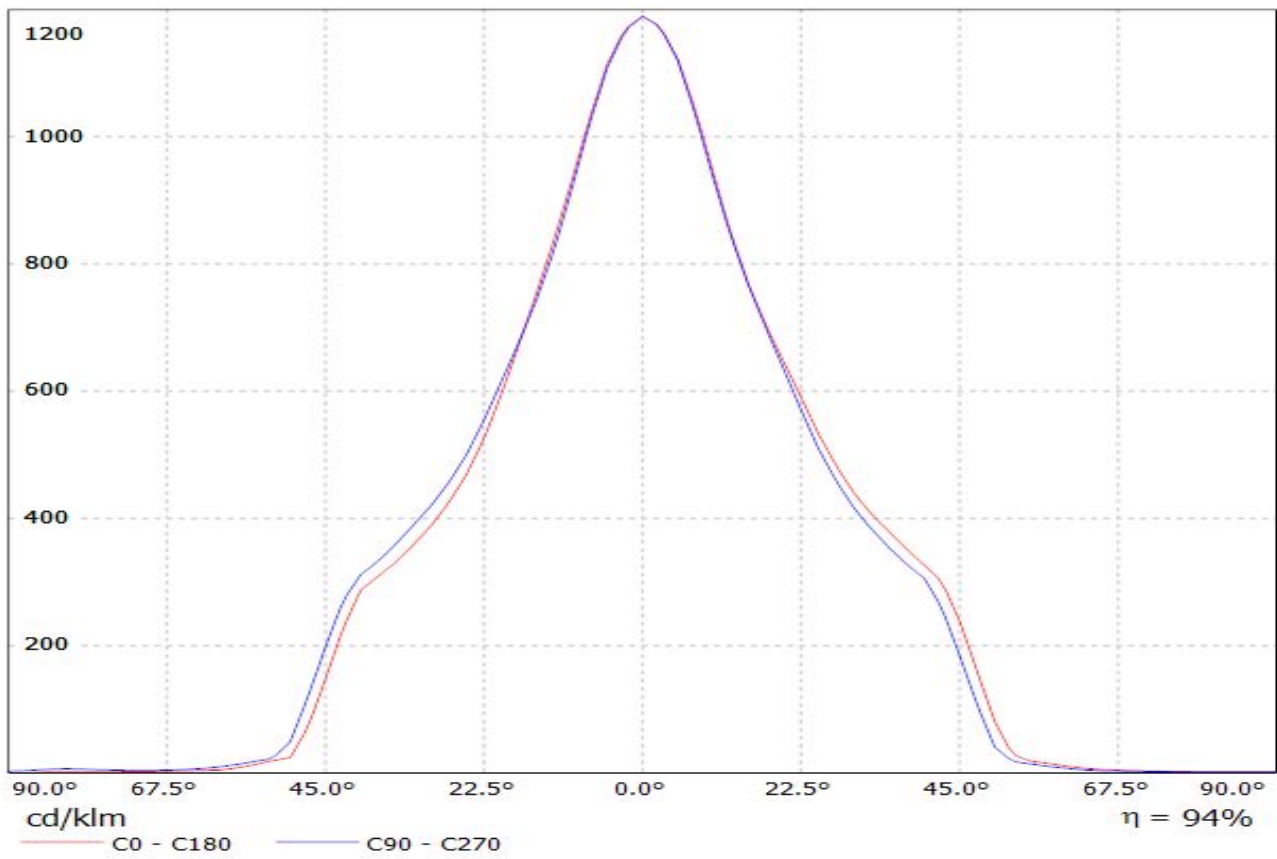

Luminaire: LEDiL Oy F13402_ANGELINA-W_(NSBxL121A) Eff.90.9%
Lamps: 1 x NICHIA_NSBxL121A_(NSBLL121AE)_805.561lm@250mA_CCT=3000K_P=7.3681W_I=249.8mA

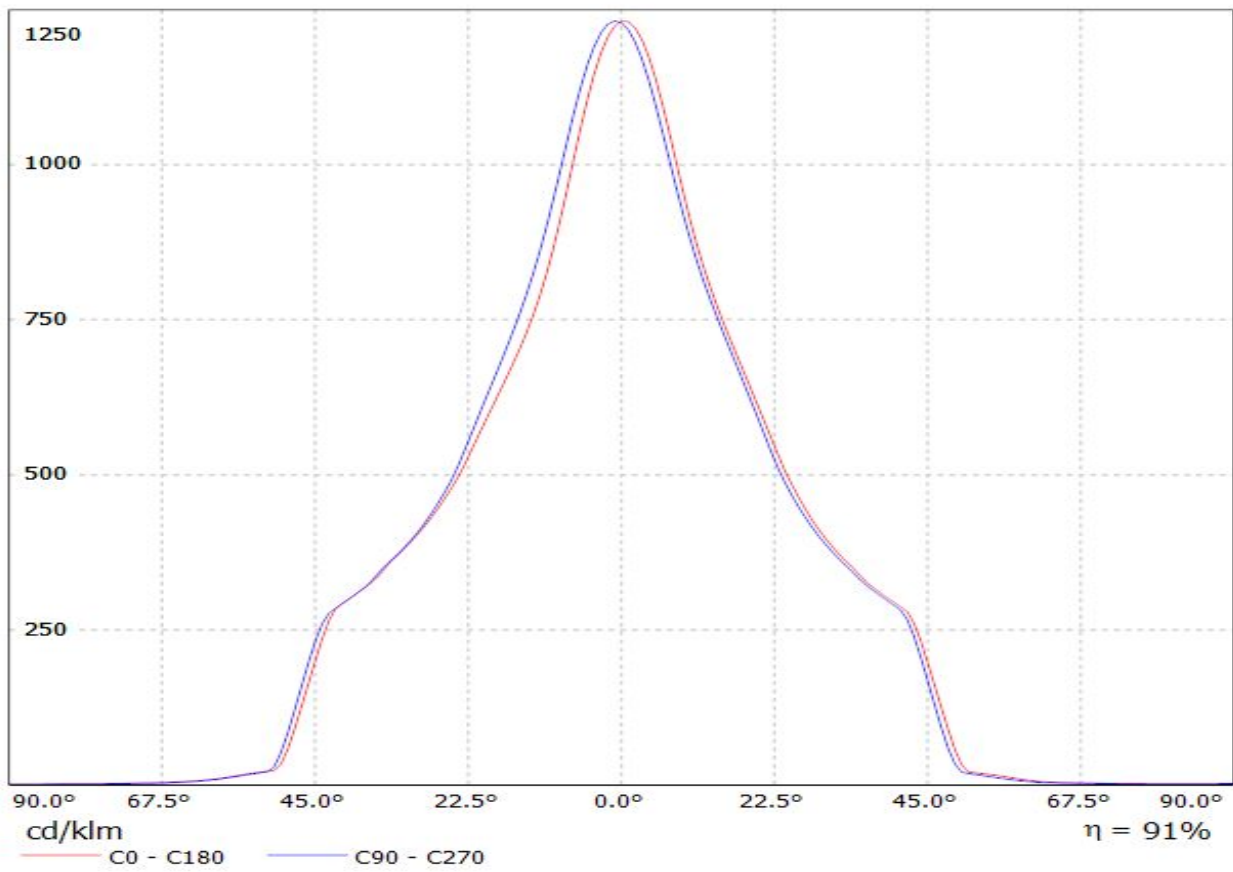

Luminaire: LEDiL Oy F13402_ANGELINA-W_(NSBxL121A)
Lamps: 1 x Nichia_NSBxL121A_914.478lm@250mA_P=7.56872W_I=249.9mA

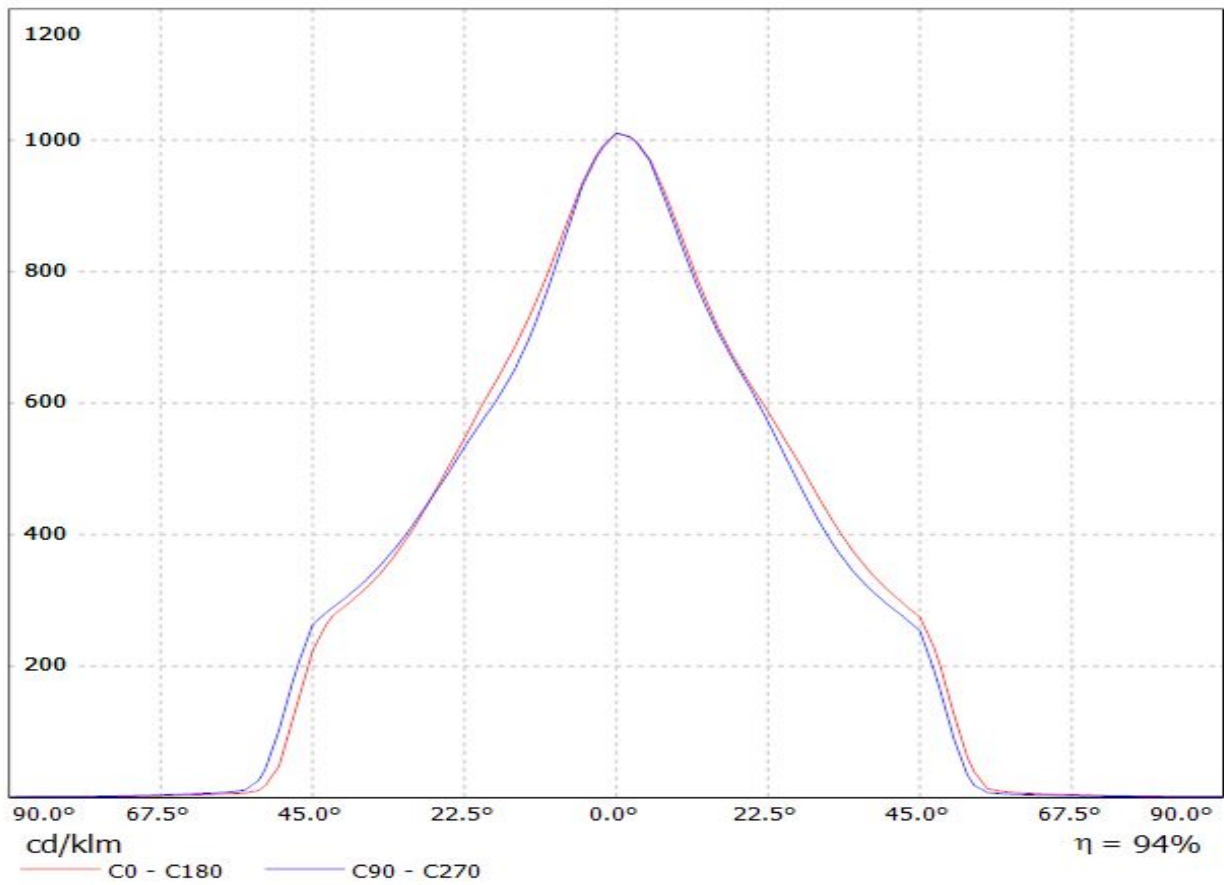

Luminaire: Ledil F13402_ANGELINA-W_(NVCLL024Z+TE)

Lamps: 1 x Nichia_NVCLL024Z_+2213382-2_+2213194-1_971.485lm@250mA_CCT=3000K_P=8W_I=0.25A

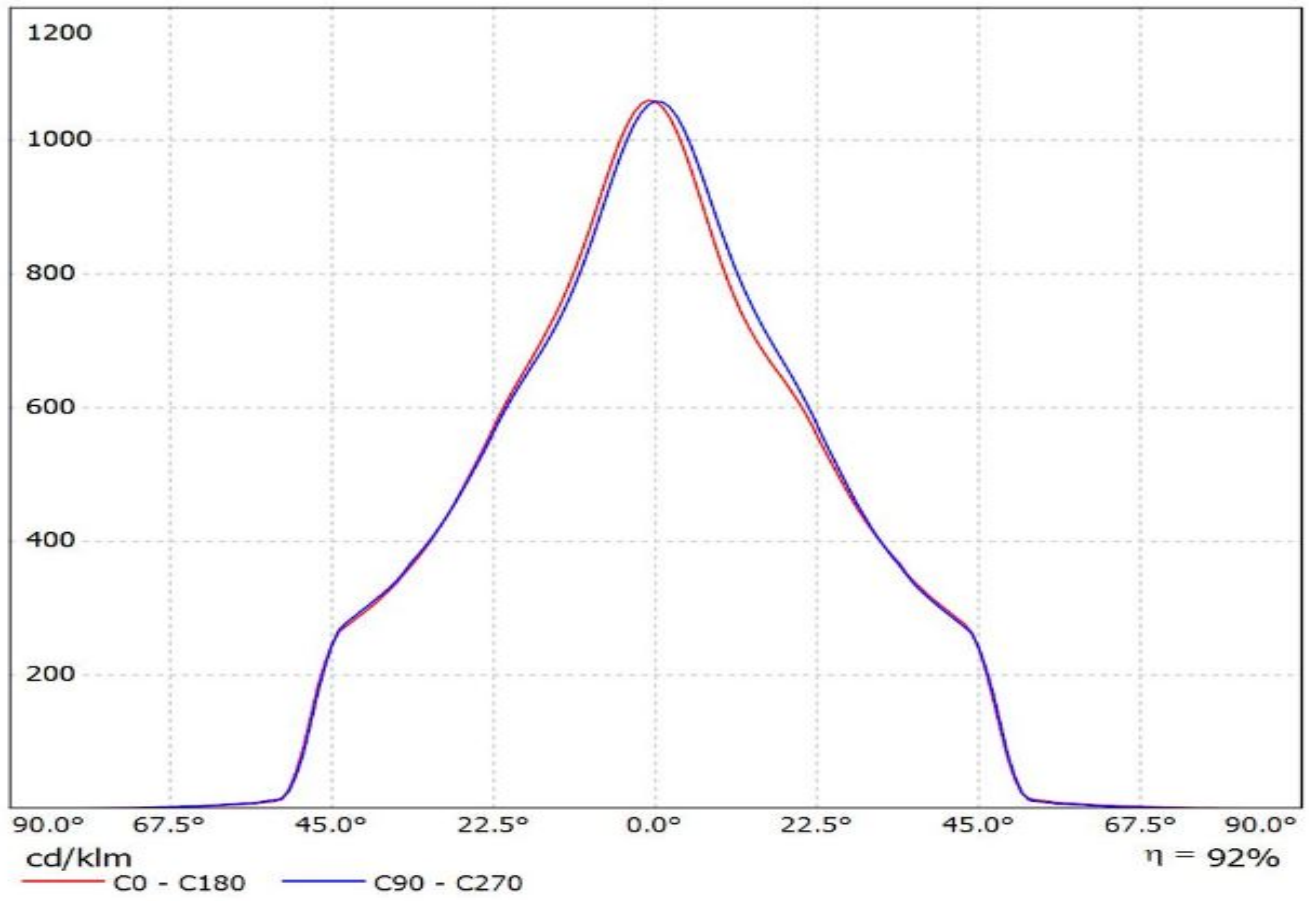

Luminaire: LEDiL Oy F13402_ANGELINA-W_(PrevaLED_LES9) Eff. 93%
Lamps: 1 x PrevaLED_LES9_(PL-CORE-1100-830-Z3)_507.9lm@100mA_P=4.5039W_I=100.1mA

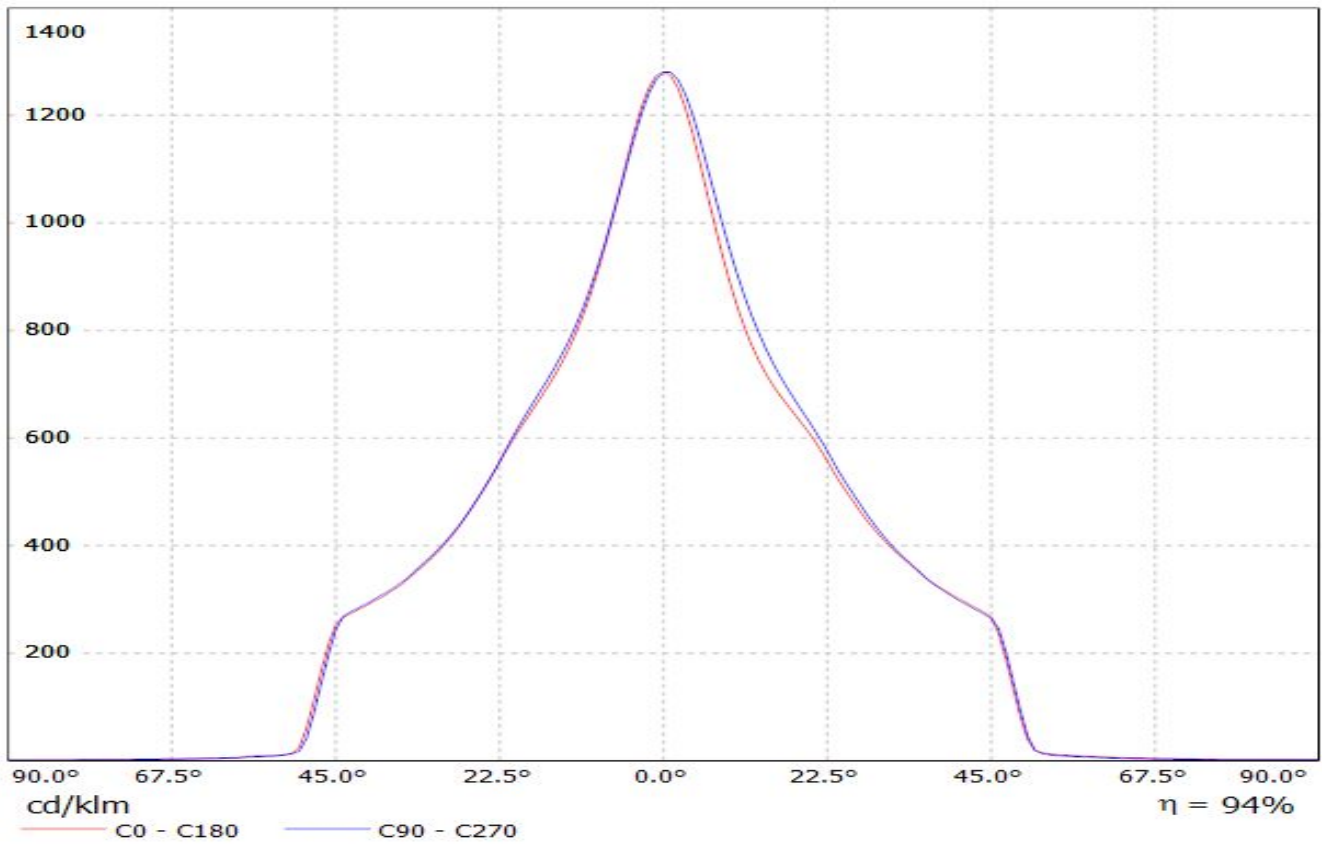

Luminaire: LEDiL Oy F13402_ANGELINA-W_(PrevaLED_LES23) Eff. 94%
Lamps: 1 x OSRAM PrevaLED_LES23_(PL-CORE-5000-930-Z3)_1102.2lm@250mA_P=9.93654W_I=249.8mA

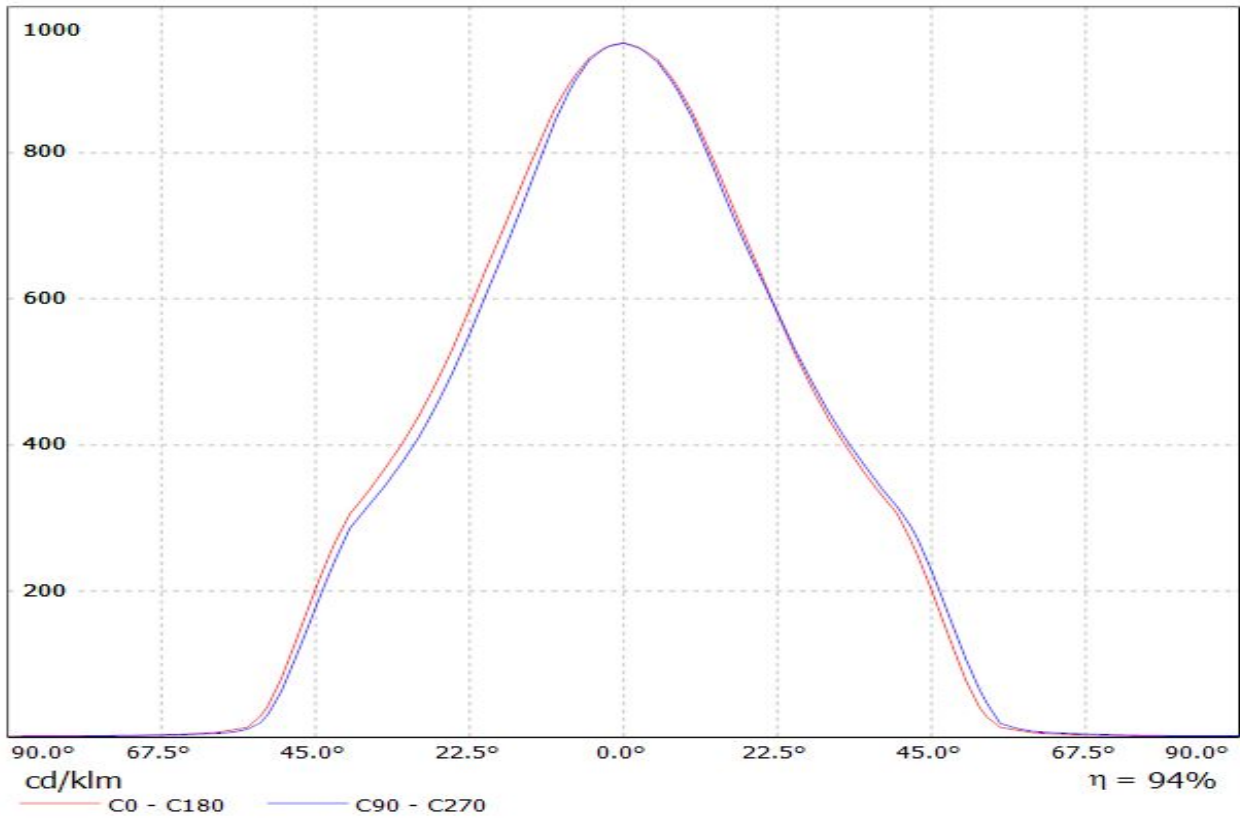

Luminaire: LEDiL Oy F13402_ANGELINA-W_(PrevaLED_LES19)

Lamps: 1 x PrevaLED_LES19_(PL-CORE-2000-830-Z3)_1333.47lm@250mA_P=10.4584W_I=249.8mA

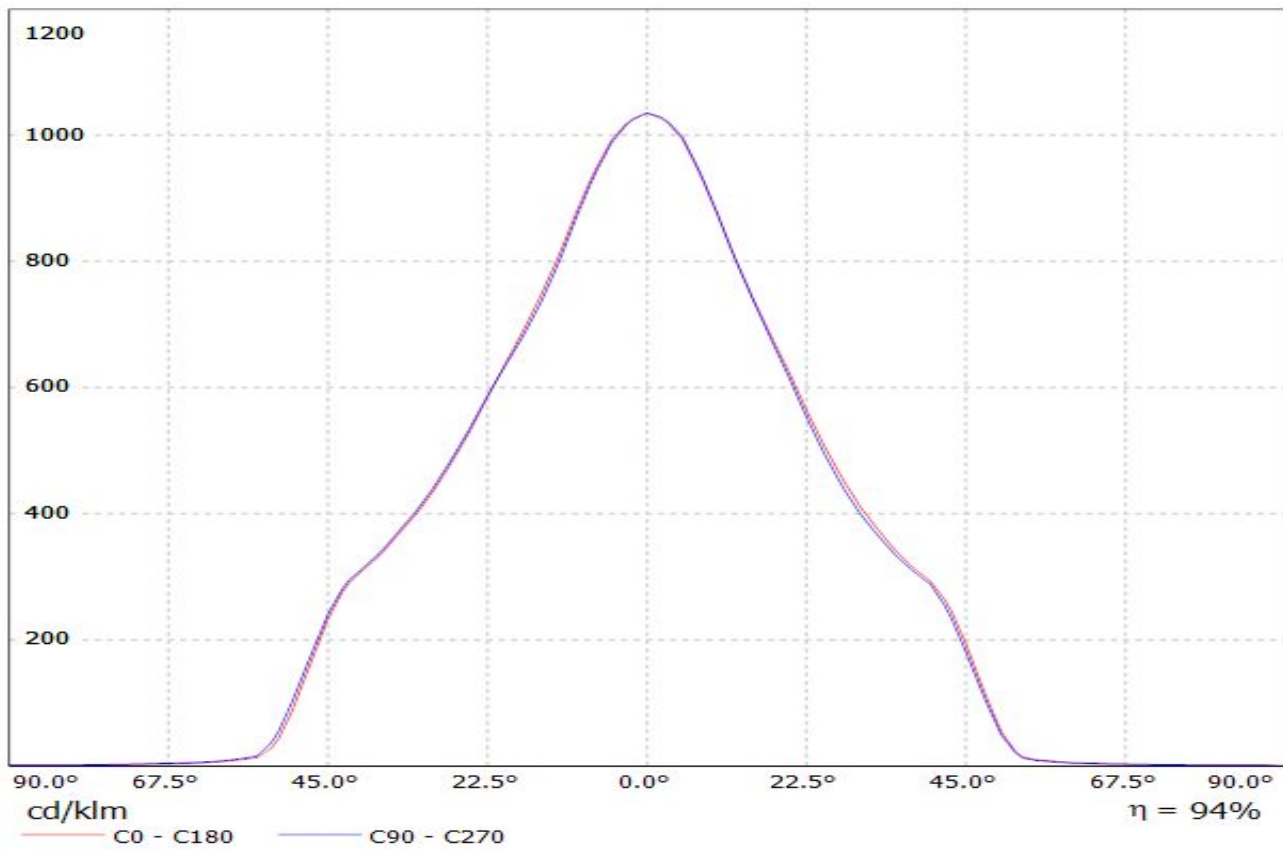

Luminaire: LEDil Oy F13402_ANGELINA-W_(Soleriq_S13) Efficiency=94%
Lamps: 1 x Osram Soleriq S13 (GW KAGHB1.EM) 855lm @ 250mA CCT=3100K P=7.5W I=250mA

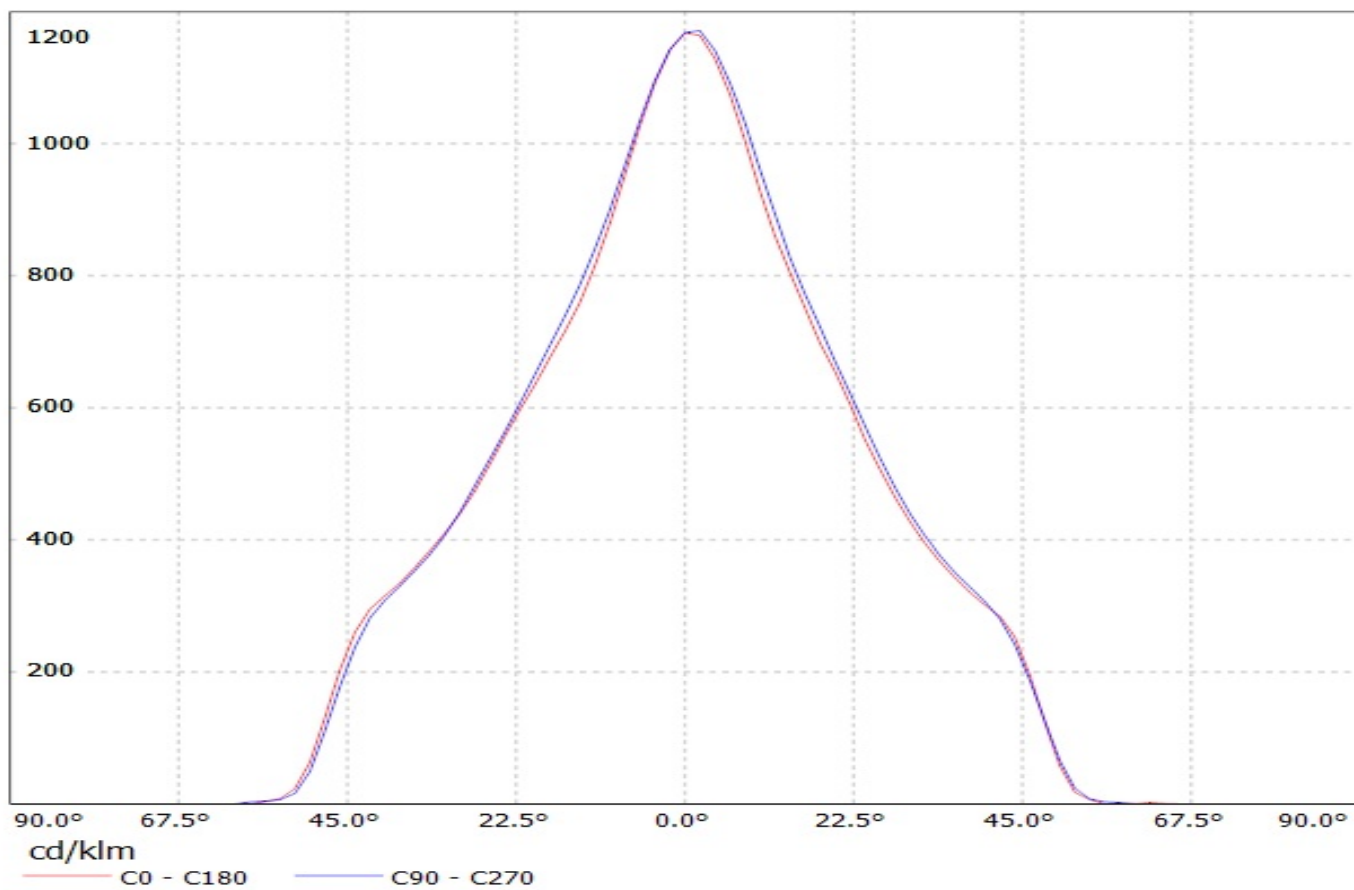

Luminaire: LEDiL Oy F13402_ANGELINA-W_(SOLERIQ_S19_&_TE_2213407-2)
Lamps: 1 x OSRAM_SOLERIQ_S19_(GW_KAHJB1.EM)_1393.62lm@250mA_CCT=3000K_P=10.5683W_I=249.8mA

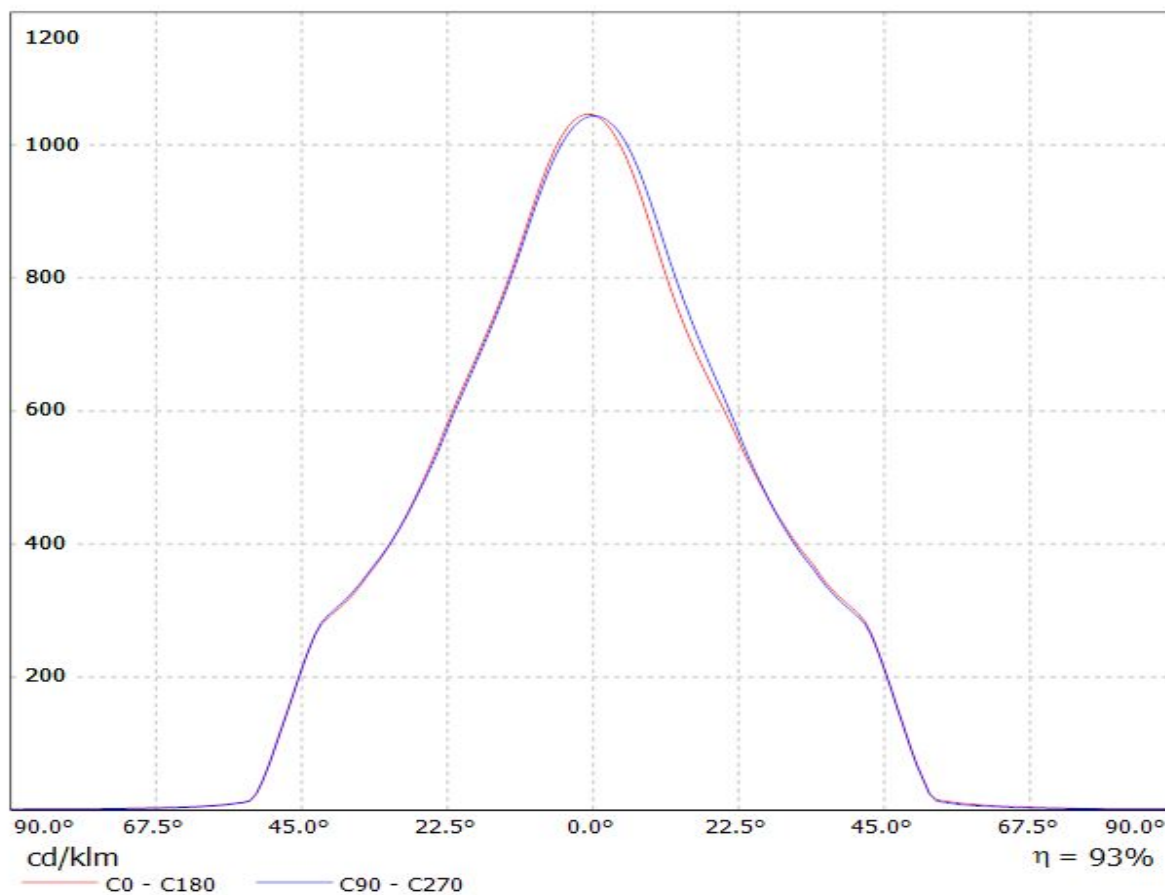

Luminaire: LEDiL Oy F13402_ANGELINA-W (LEP-800-827-C-AC)

Lamps: 1 x OSRAM PrevaLED Core AC (LEP-800-827-C-AC) 910lm@60mA U:230V P:14W

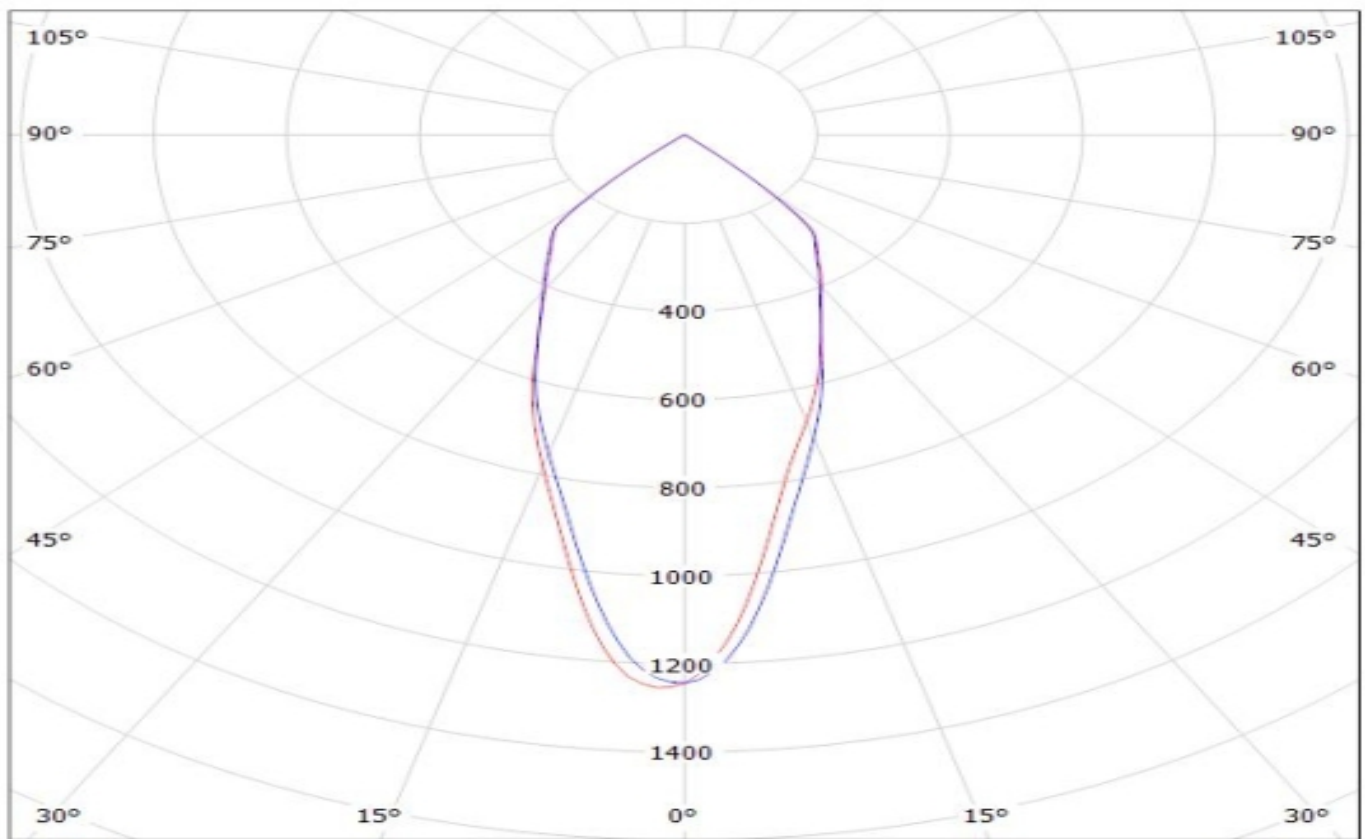

cd/klm

C0 - C180

C90 - C270

$\eta = 93\%$

Luminaire: LEDiL Oy F13402_ANGELINA-W (LEP-2000-827-C-AC)
Lamps: 1 x OSRAM PrevaLED Core AC (LEP-2000-827-C-AC)

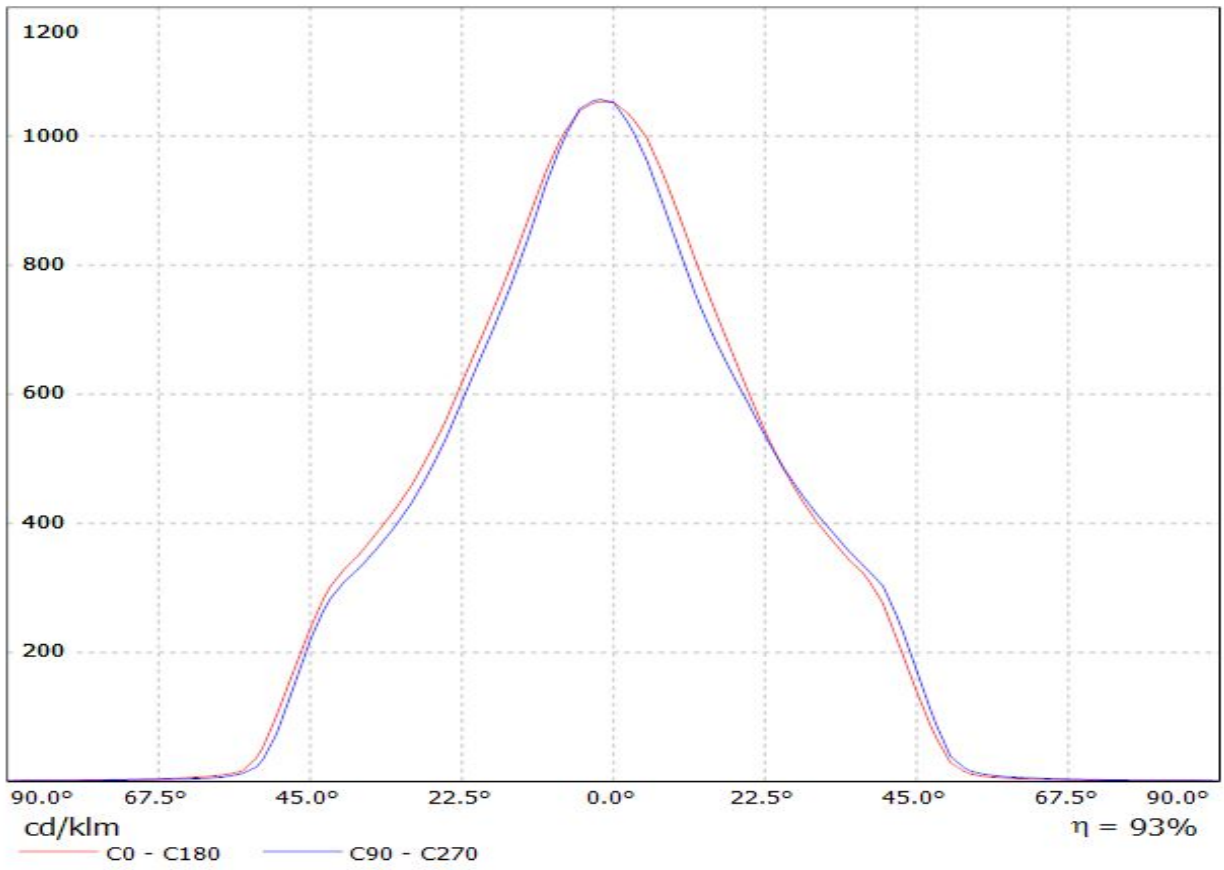

Luminaire: LEDiL Oy F13402_ANGELINA-W_(PrevaLED_Z4) Eff: 93%
Lamps: 1 x Osram_PrevaLED_CORE_Z4_(PL-CORE-3000-830-Z4)_1423.93lm@250mA_P=10.7652W_I=249.9mA

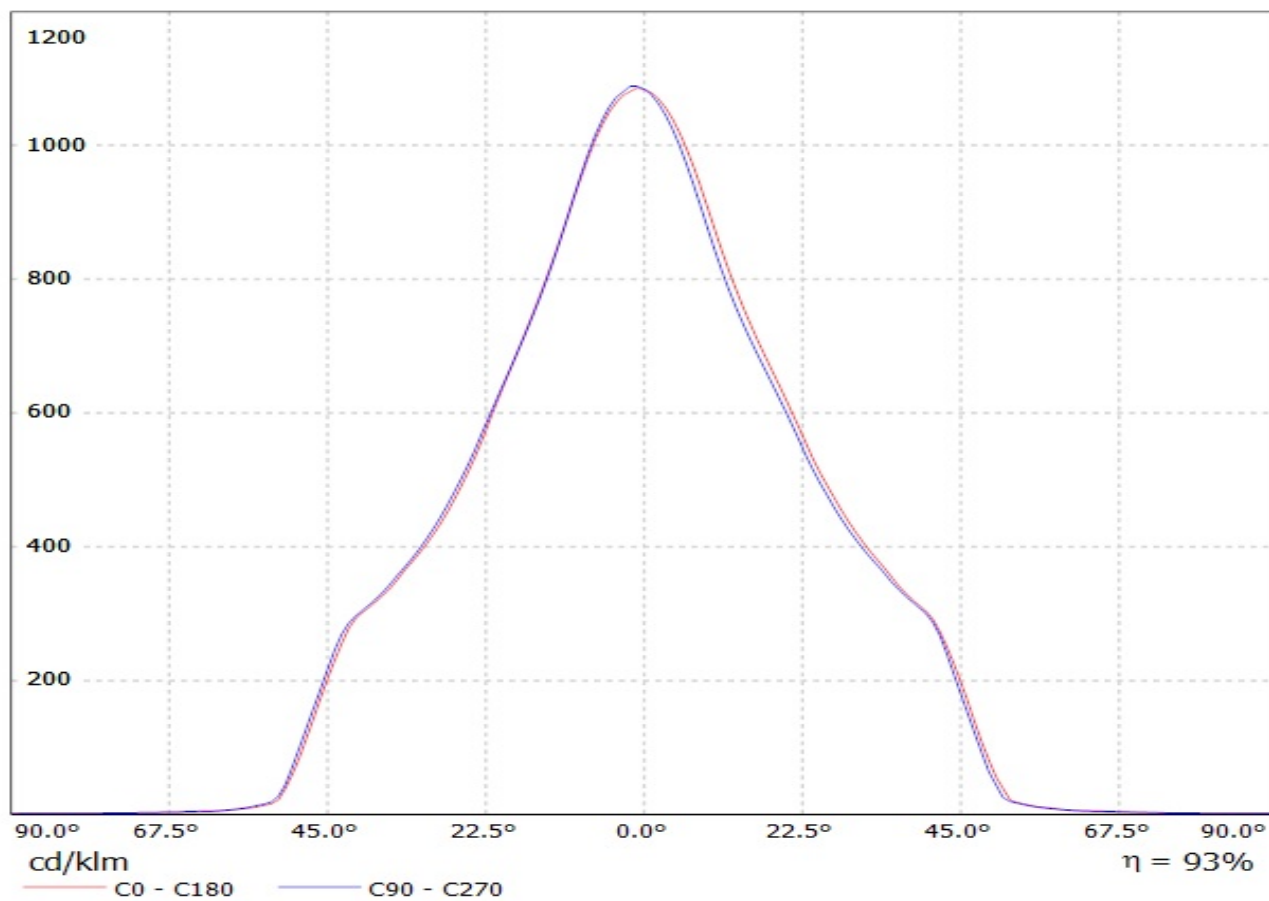

Luminaire: LEDiL Oy F13402_ANGELINA-W (SOLERIQ_P13)

Lamps: 1 x SOLERIQ_P13_(GW_MAGMB1.EM)_1038.25lm@250mA_CCT=3000K_P=8.77223W_I=249.8mA

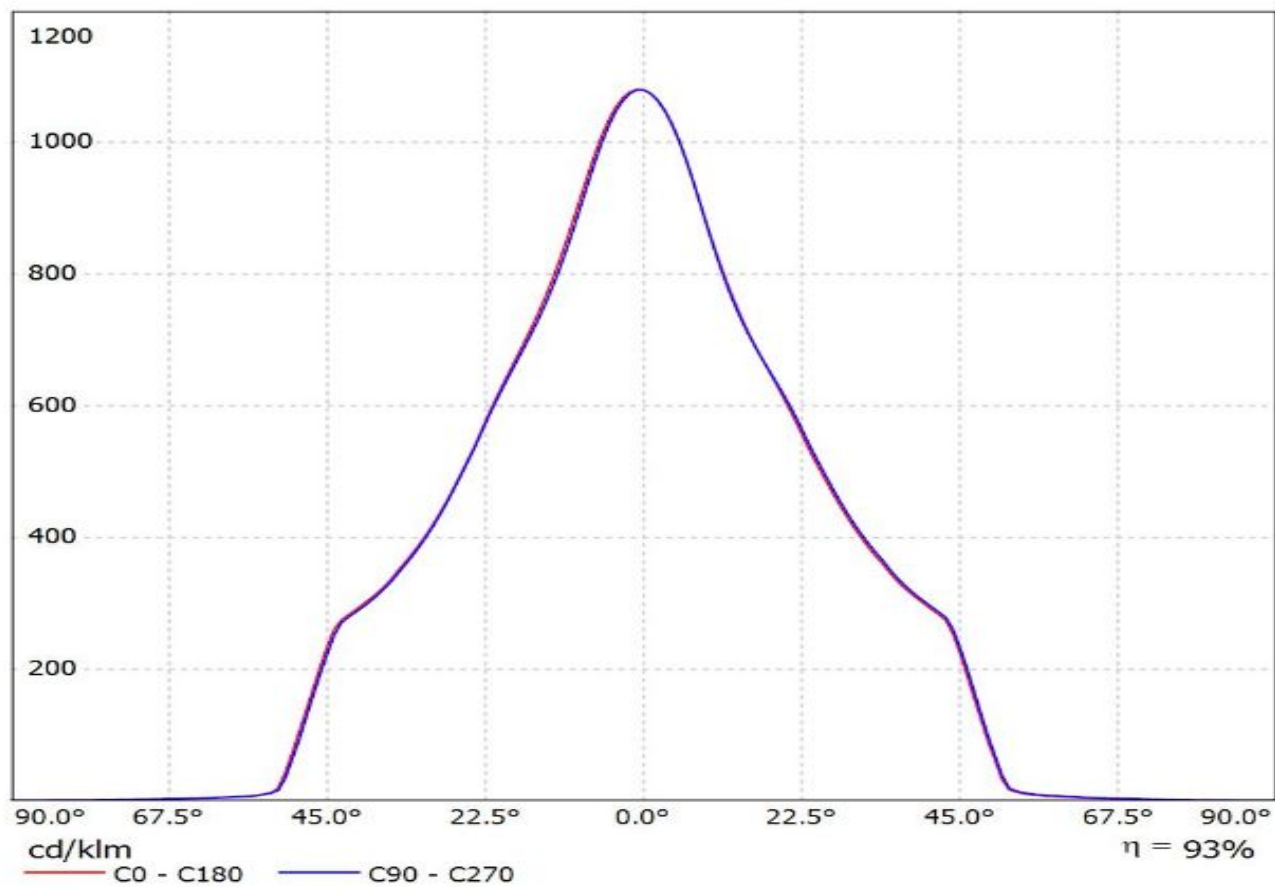

Luminaire: Ledil F13402_ANGELINA-W (S13_Gen2+TE)

Lamps: 1 x Soleriq_S13_Gen2+_2213254-2+_2213194-1_1309.23lm@250mA_P=8.7840W_I=0.250A

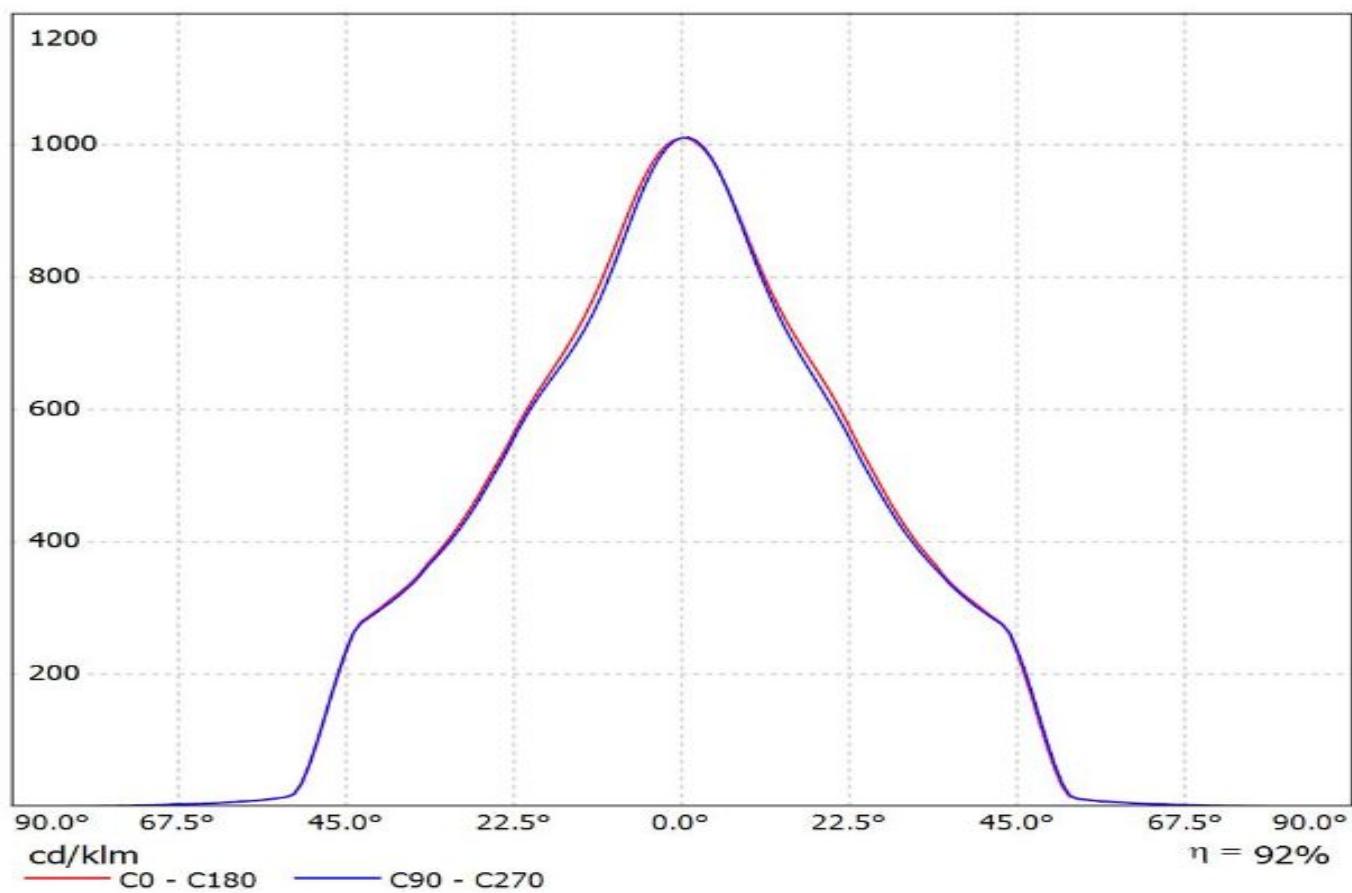

Luminaire: Ledil F13402_ANGELINA-W_(S13_Gen2+IDEAL)

Lamps: 1 x Soleriq_S13_Gen2+_50-2103CT+_50-2100AN_1327.38lm@250mA_P=8.7850W_I=0.250A

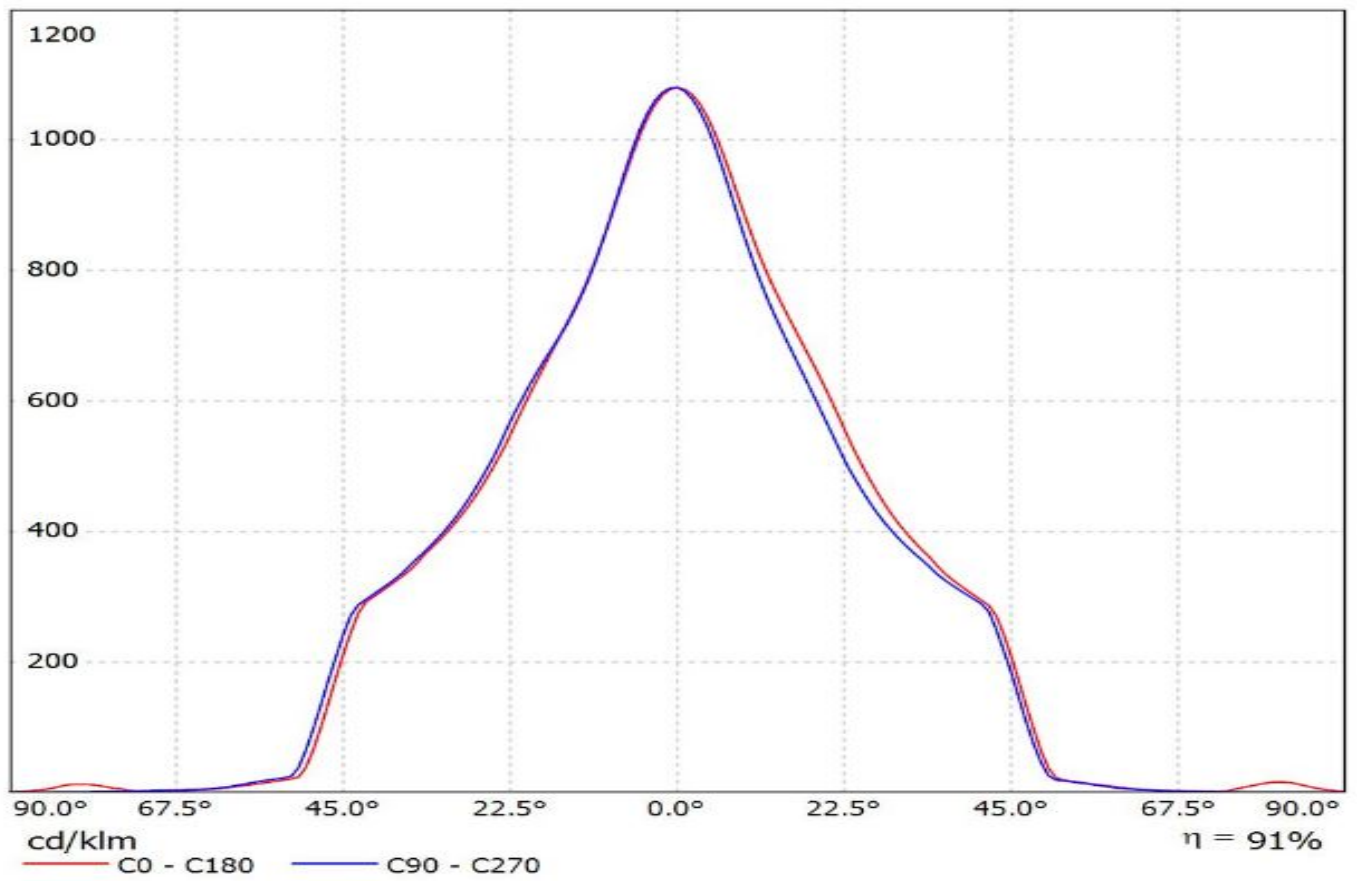

Luminaire: LEDiL Oy F13402_ANGELINA-W_(FORTIMO_2000) Eff.90.5%
Lamps: 1 x PHILIPS Fortimo LED SLM 3000 28W/830 L19 G3 665.774lm@250mA CCT=3000K P=6W I=250mA

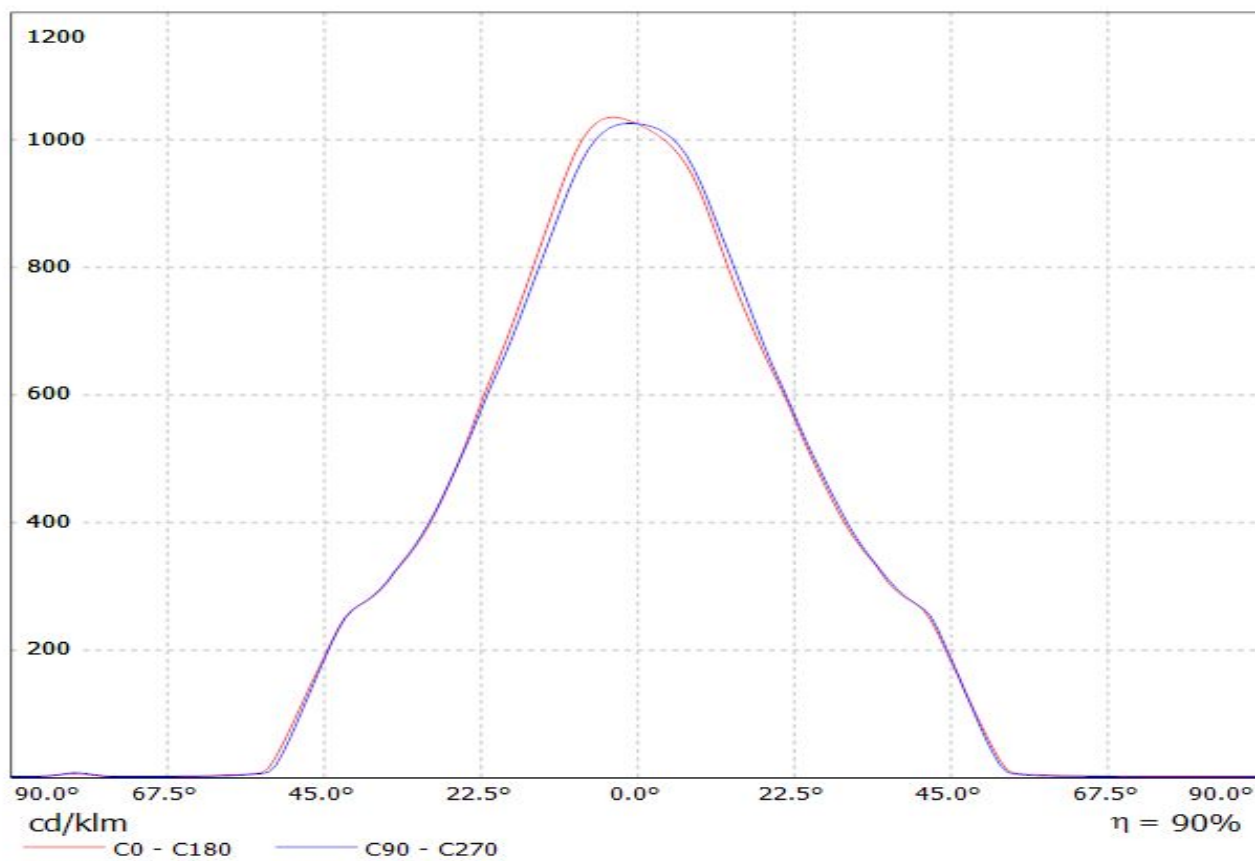

Luminaire: LEDiL Oy F13402_ANGELINA-W_(FORTIMO_3000) Eff.90.2%
Lamps: 1 x PHILIPS Fortimo LED SLM 3000 28W/830 L19 G3 1046.76lm@250mA CCT=3000K P=9W I=250mA

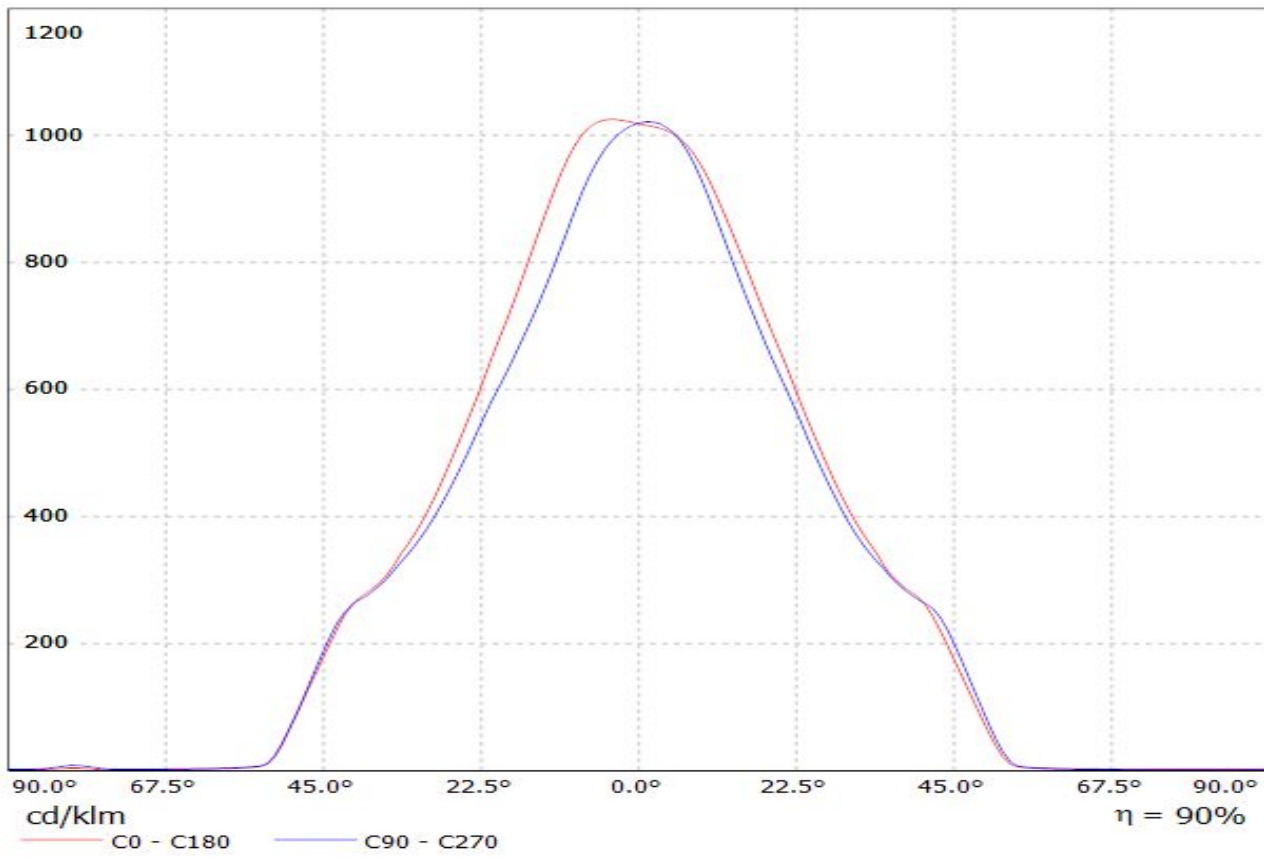

Luminaire: LEDiL Oy F13402_ANGELINA-W_(FORTIMO_4500) Eff.89.0%
Lamps: 1 x PHILIPS Fortimo 4500

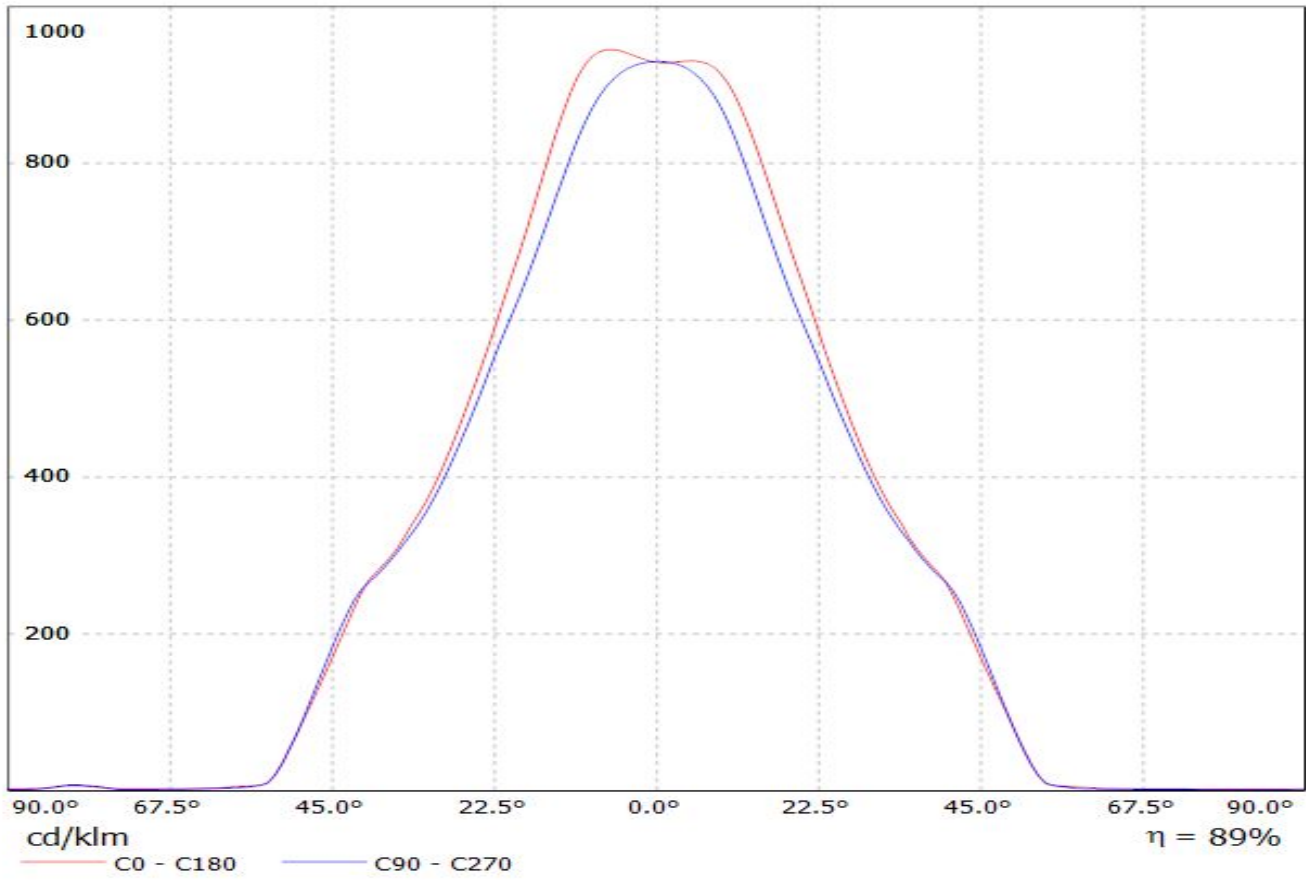

Luminaire: Ledil F13402_ANGELINA-W_(SLM_1211_L19_G6_+TE)

Lamps: 1 x Philips_Fortimo_SLM_1211_L19_G6_Standard_+_TE_OPTIC_CLIP_Z50_TYPE1:_2213194-1_1146.84lm@250mA_P=8.13175W_I=0.25A

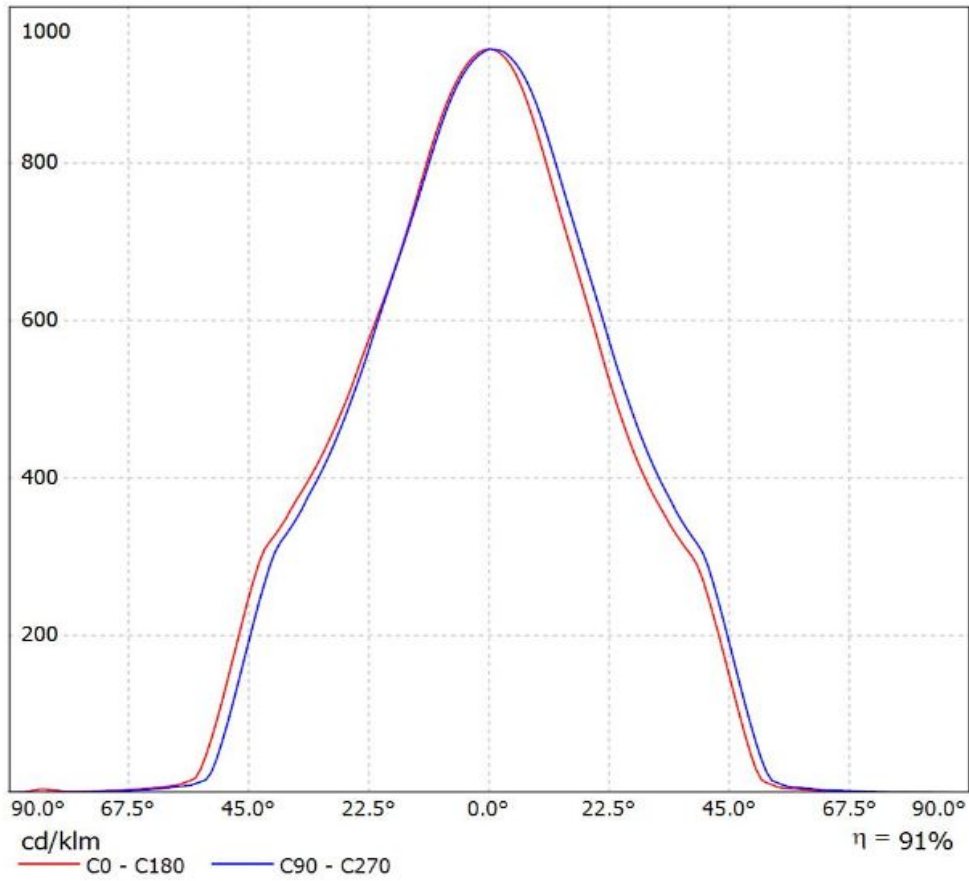

Luminaire: LEDiL Oy F13402_ANGELINA-W_(Fortimo LED SLM 1100 lm 830 L9 G4)
Lamps: 1 x Fortimo LED SLM 1100 lm 830 L9 G4_1021.27lm@250mA_P=9.2431W_I=0.2498A

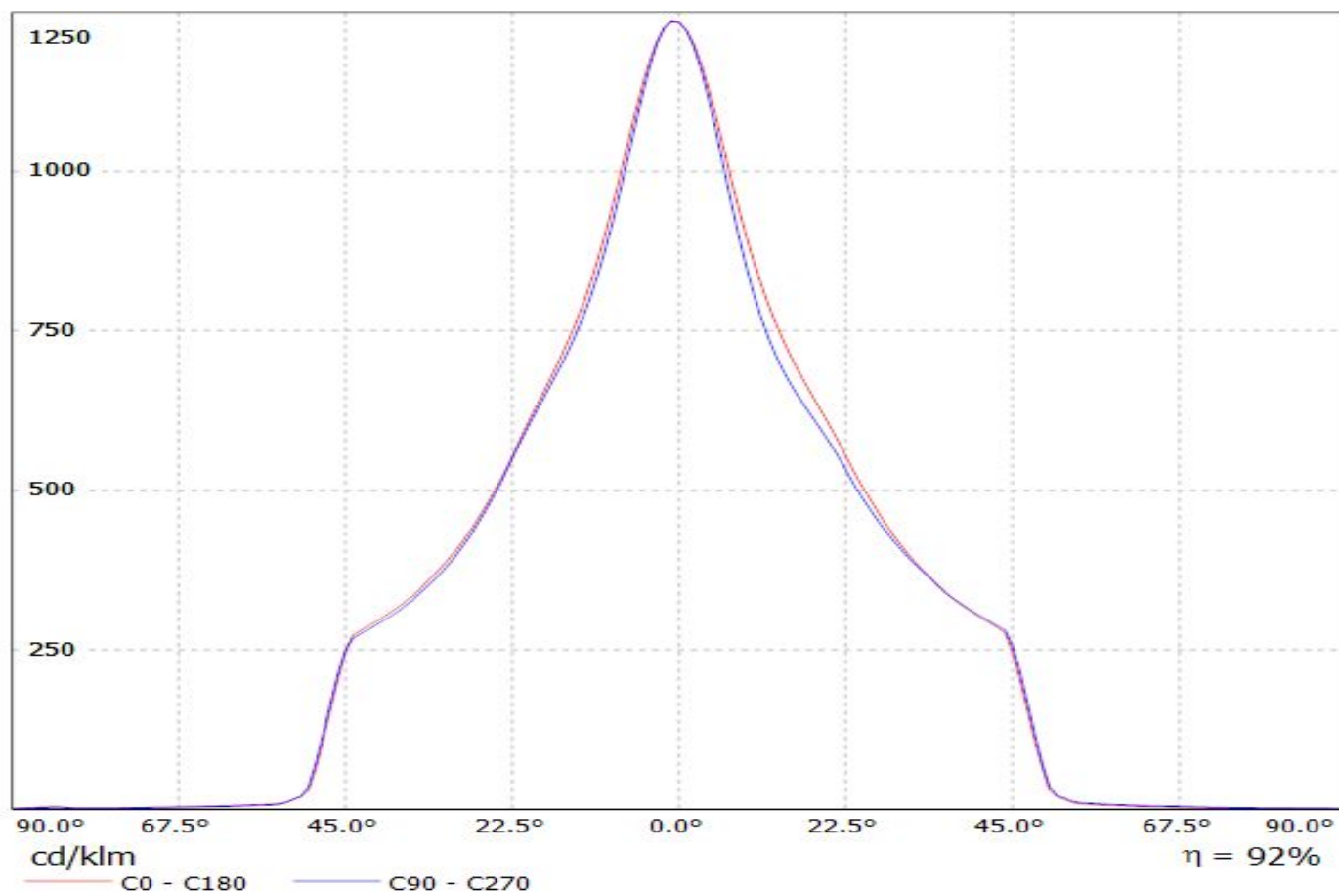

Luminaire: LEDiL Oy F13402_ANGELINA-W_(Fortimo LED SLM L13 G4)
Lamps: 1 x Fortimo LED SLM L13 G4_1110.38lm@250mA_P=8.38454W_I=0.2498A

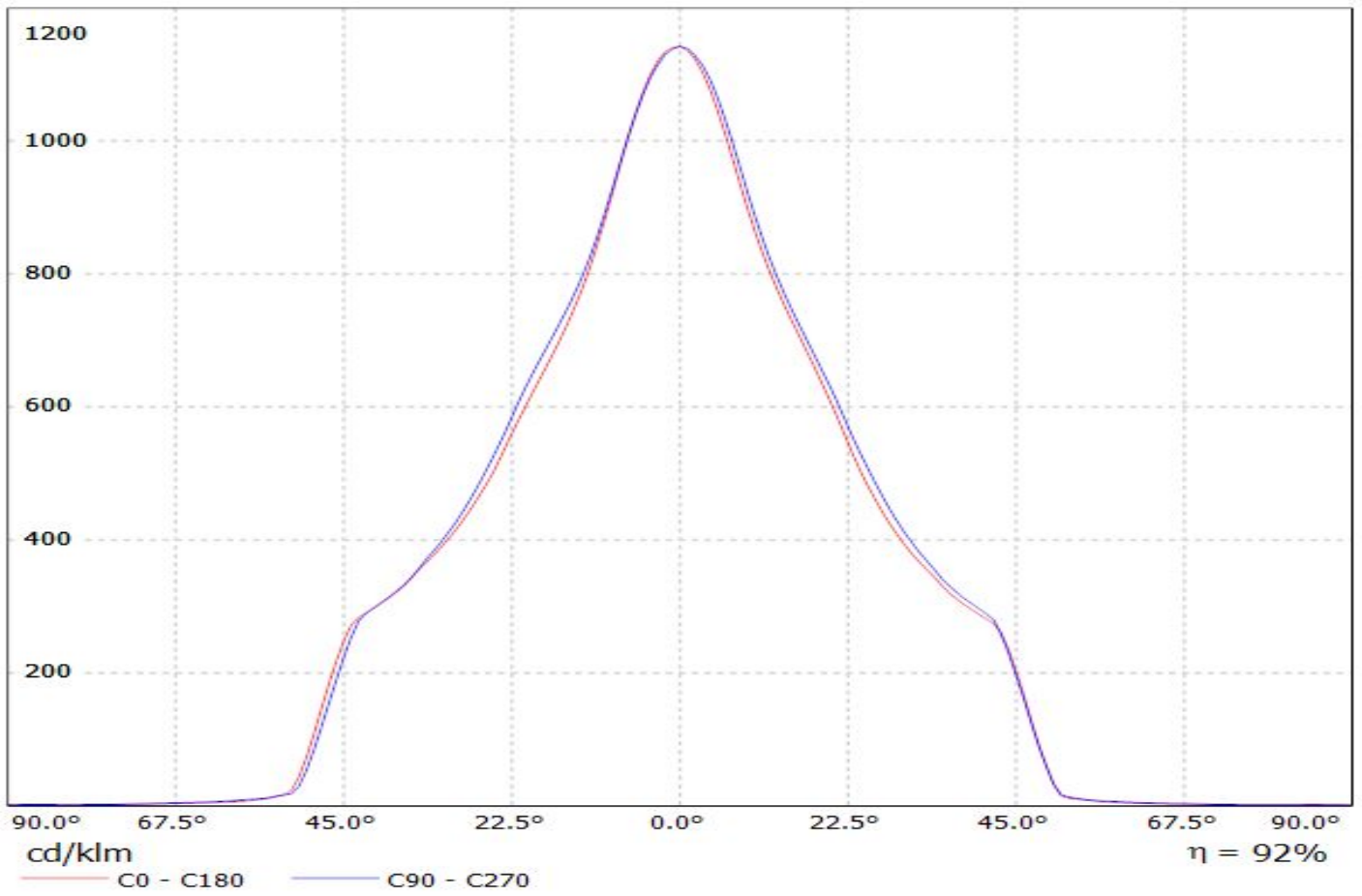

Luminaire: LEDiL Oy F13402_ANGELINA-W_(Fortimo LED SLM L15 G4)
Lamps: 1 x Fortimo LED SLM L15 G4_1116.47lm@250mA_P=8.21168W_I=0.2498A

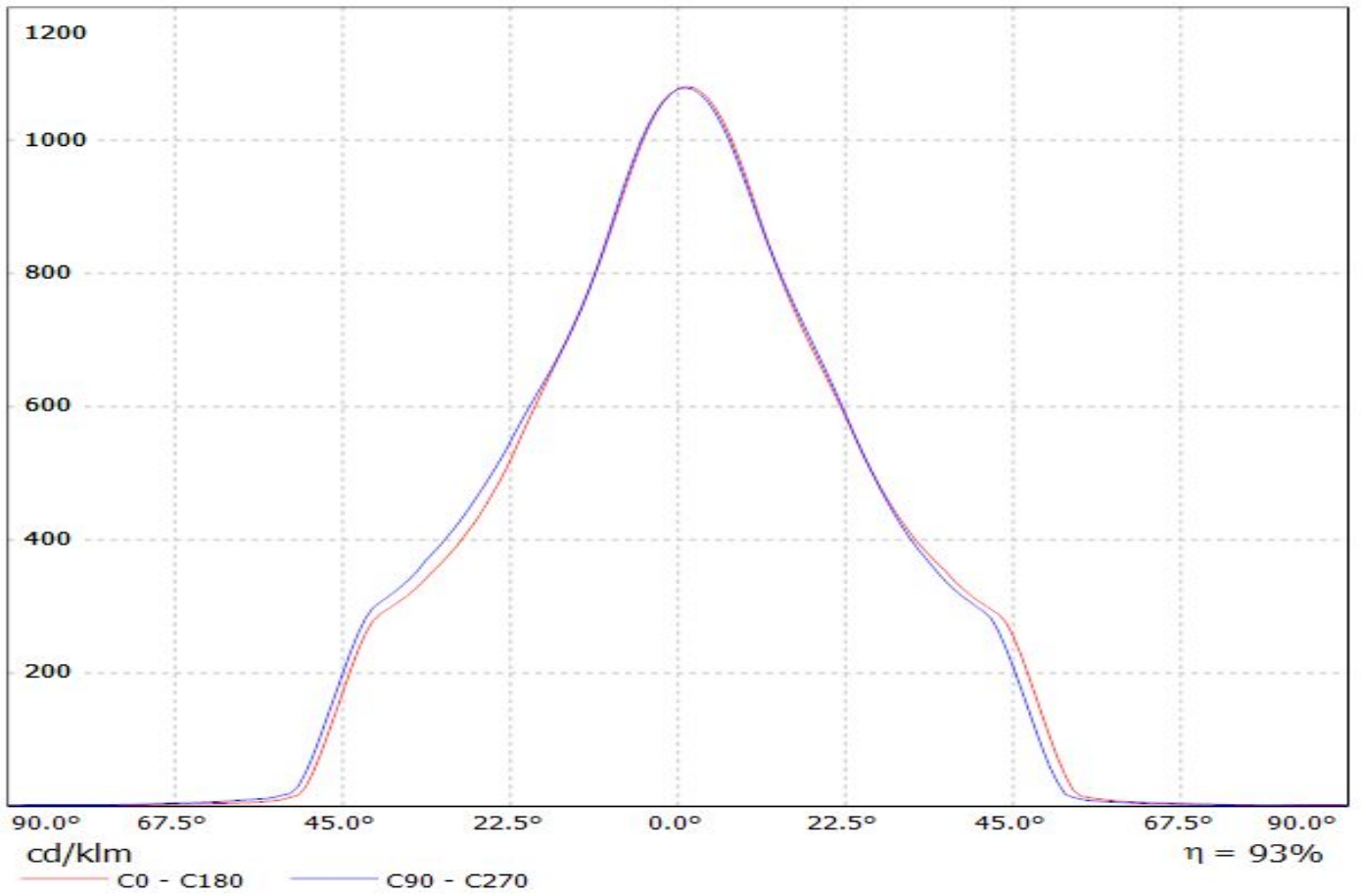

Luminaire: LEDiL Oy F13402_ANGELINA-W_(Fortimo LED SLM L19 G4)
Lamps: 1 x Fortimo LED SLM L19 G4_1114.89lm@250mA_P=8.04906W_I=0.2498A

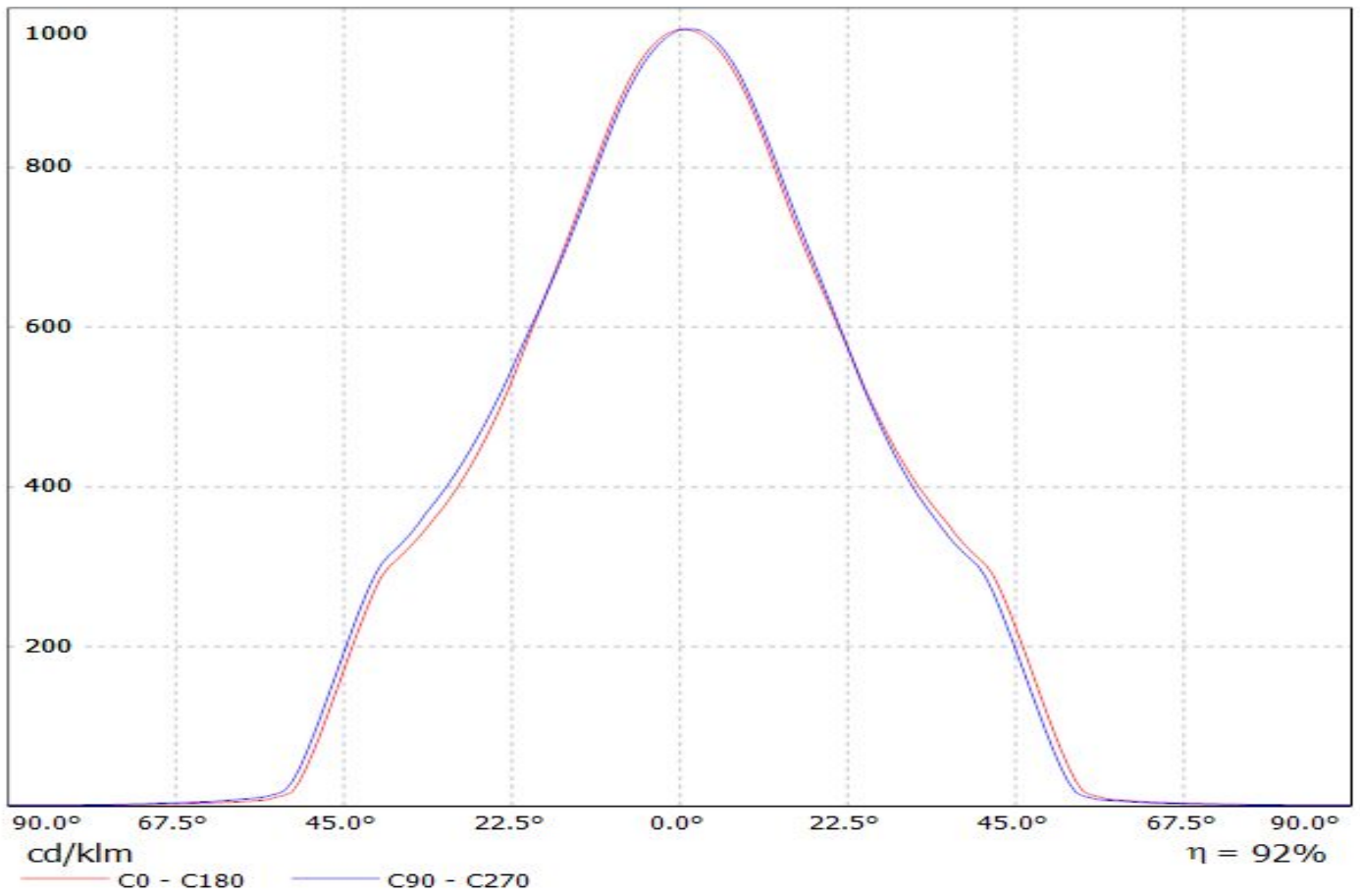

Luminaire: LEDiL Oy F13402_ANGELINA-W_(SLM-G5-LES-9)_(Z50-Optic-Clip)
Lamps: 1 x Fortimo_SLM-G5-LES-9_1182.49lm@250mA_P=8.5848W_I=0.250A

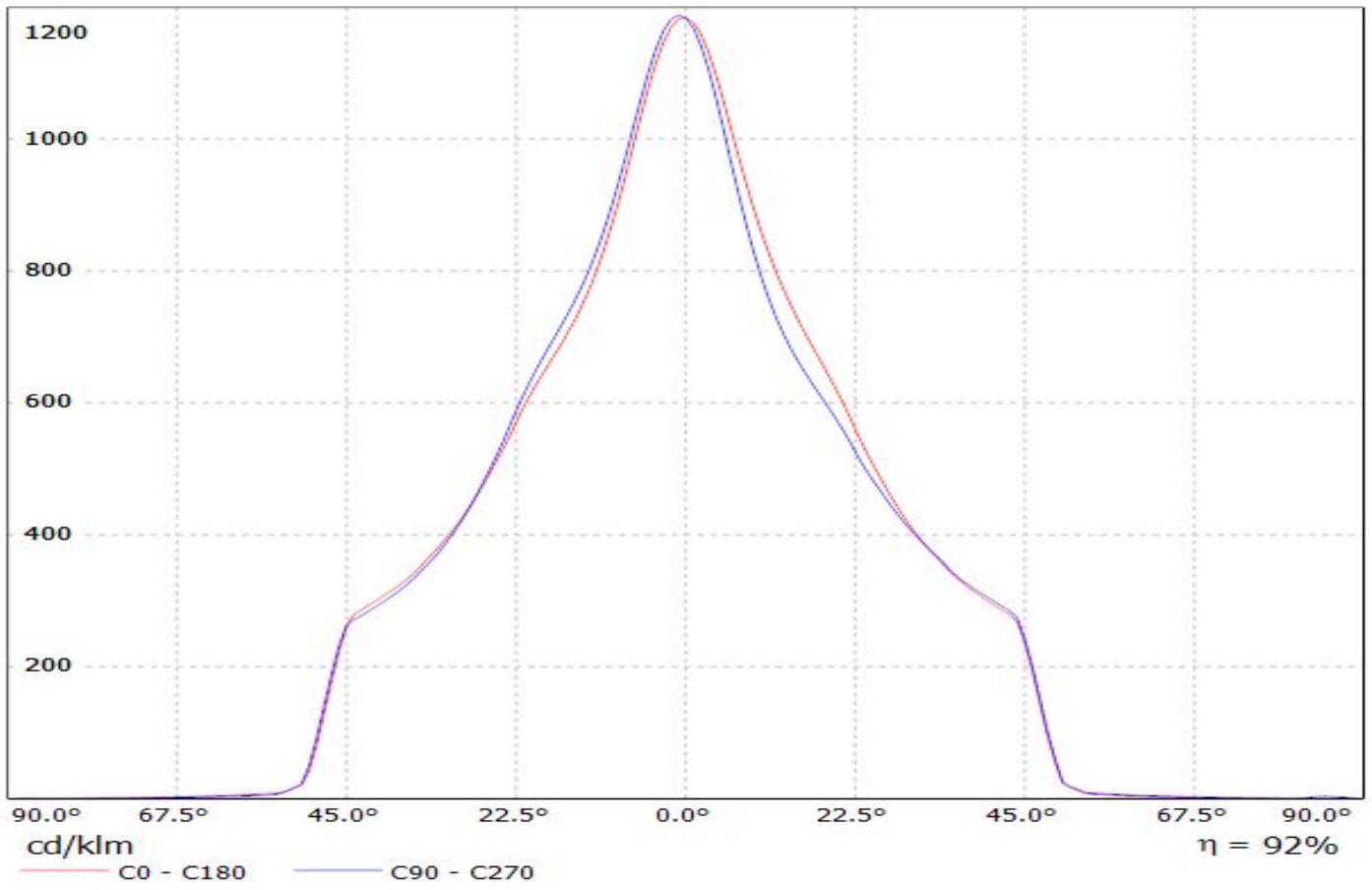

Luminaire: LEDiL Oy F13402_ANGELINA-W_(SLM-G5_LES-15)
Lamps: 1 x Fortimo_SLM-G5_LES-15_1257.61lm@250mA_P=8.1569W_I=0.250A

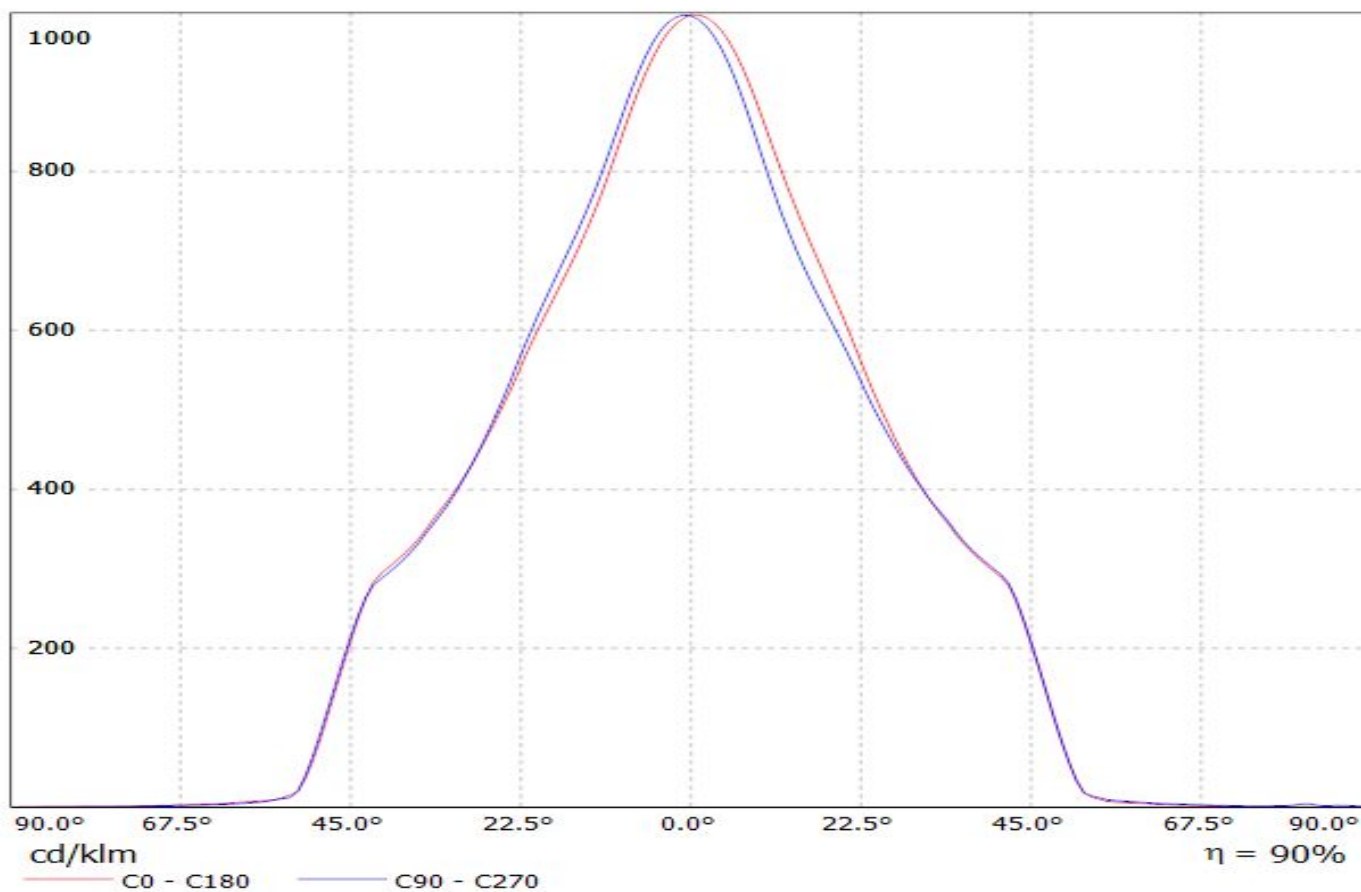

Luminaire: LEDiL Oy F13402_ANGELINA-W_(SLM-G5_LES-19)_(Z50_Optic_Clip)
Lamps: 1 x Fortimo_SLM-G5_LES-19_1397.58lm@250mA_P=8.0385W_I=0.250A

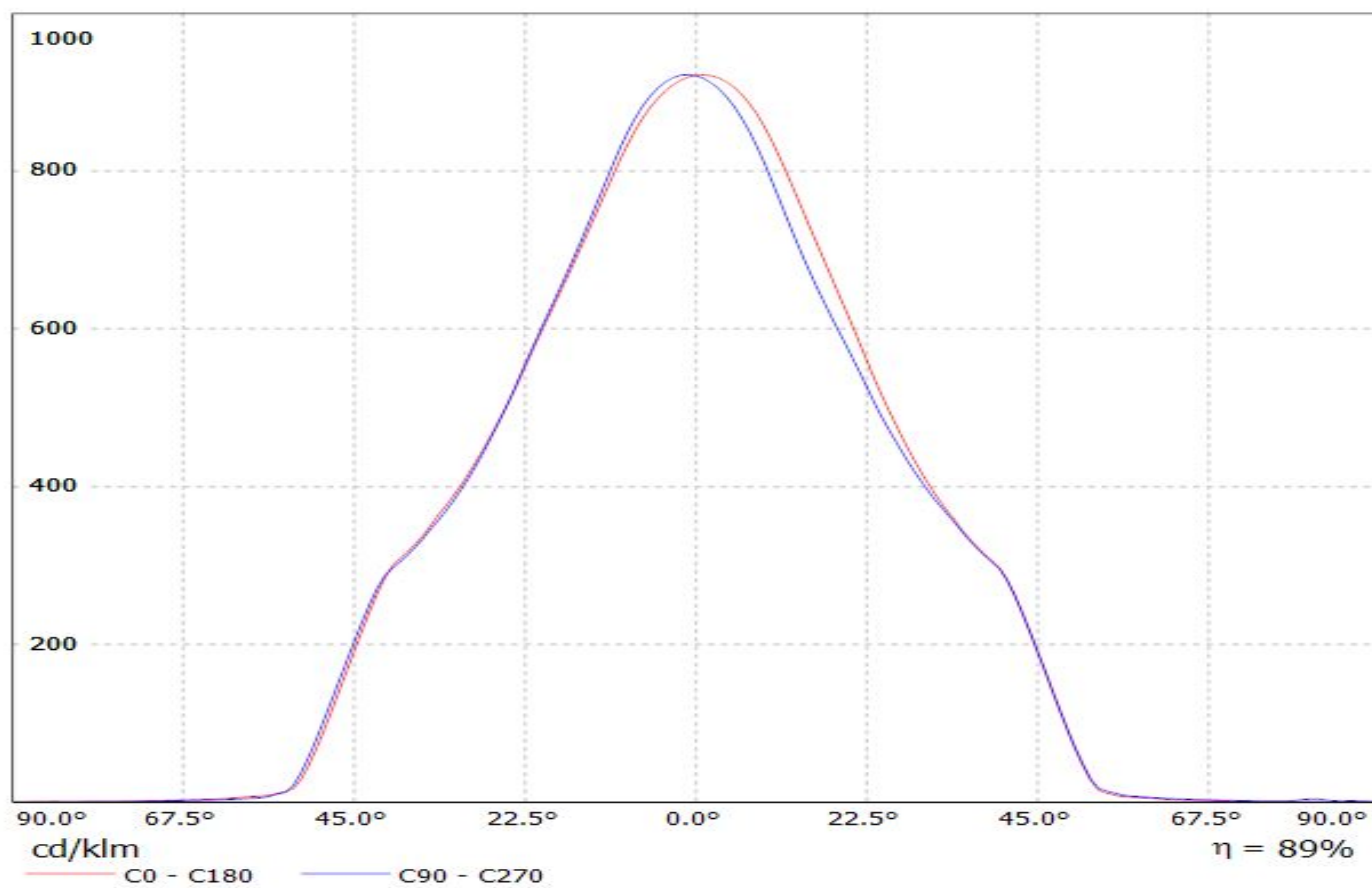

Luminaire: LEDiL Oy F13402_ANGELINA-W_(SLM-G5_LES-13)_ (Z50-Optic-Clip)
Lamps: 1 x Fortimo_SLM-G5_LES-13_1300.47lm@250mA_P=8.4010W_I=0.250A

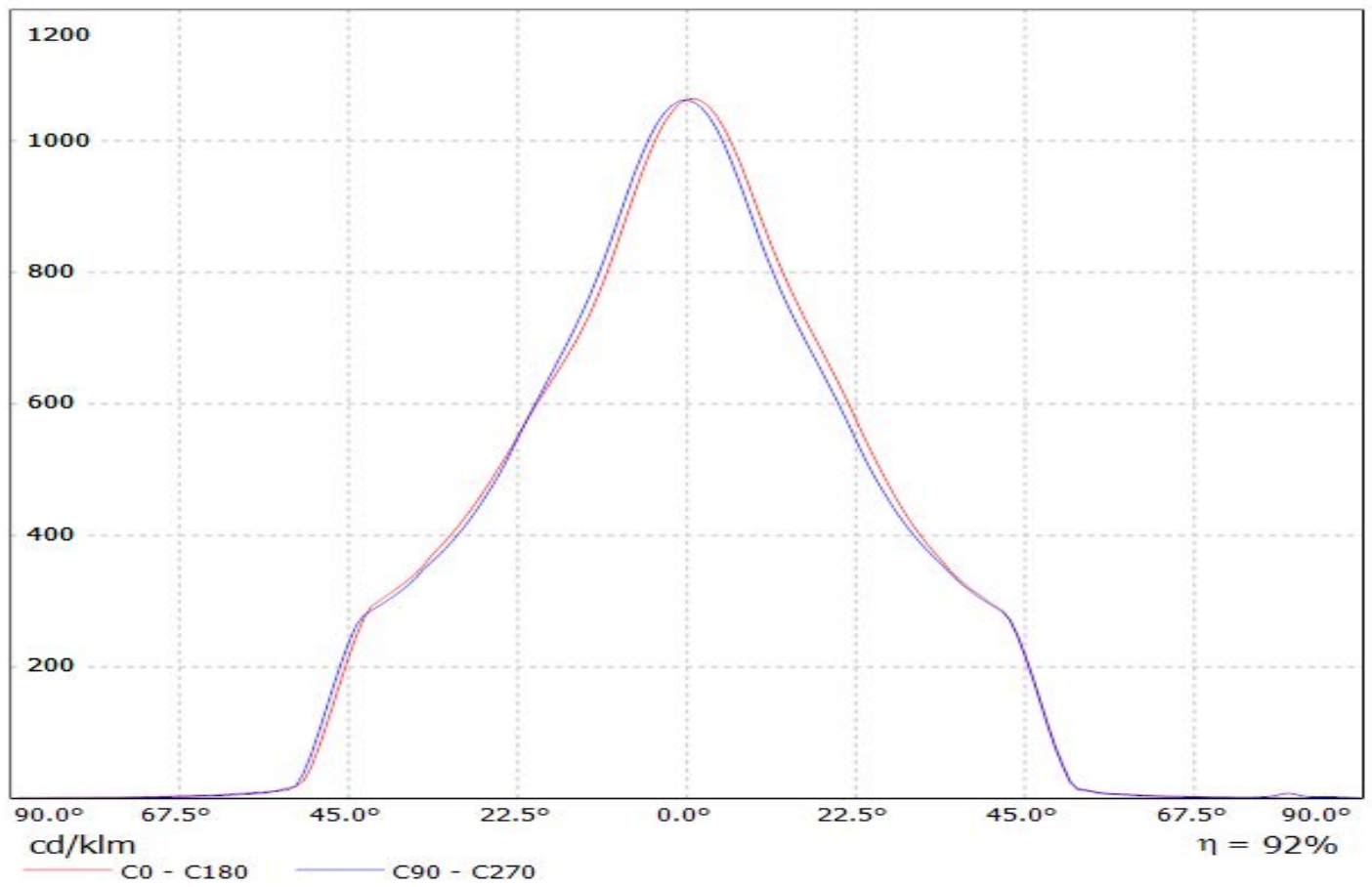

Luminaire: LEDiL Oy F13402_ANGELINA-W_(COB-LC026B) Eff.92.4%
Lamps: 1 x SAMSUNG_COB-LC026B_(SPHWWTHDNC25YHV52F)_1136.23lm@250mA_P=8.23191W_I=249.8mA

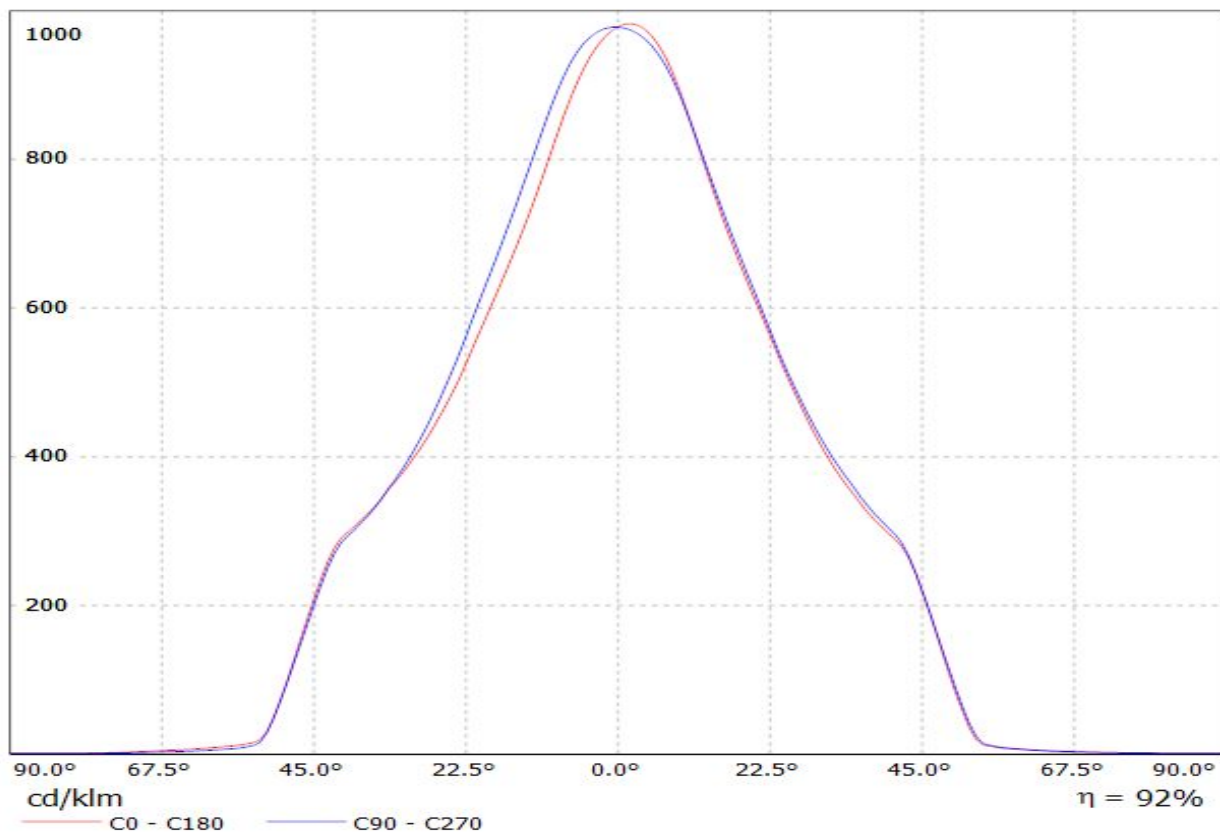

Luminaire: Ledil F13402_ANGELINA-W_(LC040C+TE)

Lamps: 1 x Samsung_LC040C+_2213382-2+_2213194-1_1194.16lm@250mA_CCT=4000K_P=8.137W

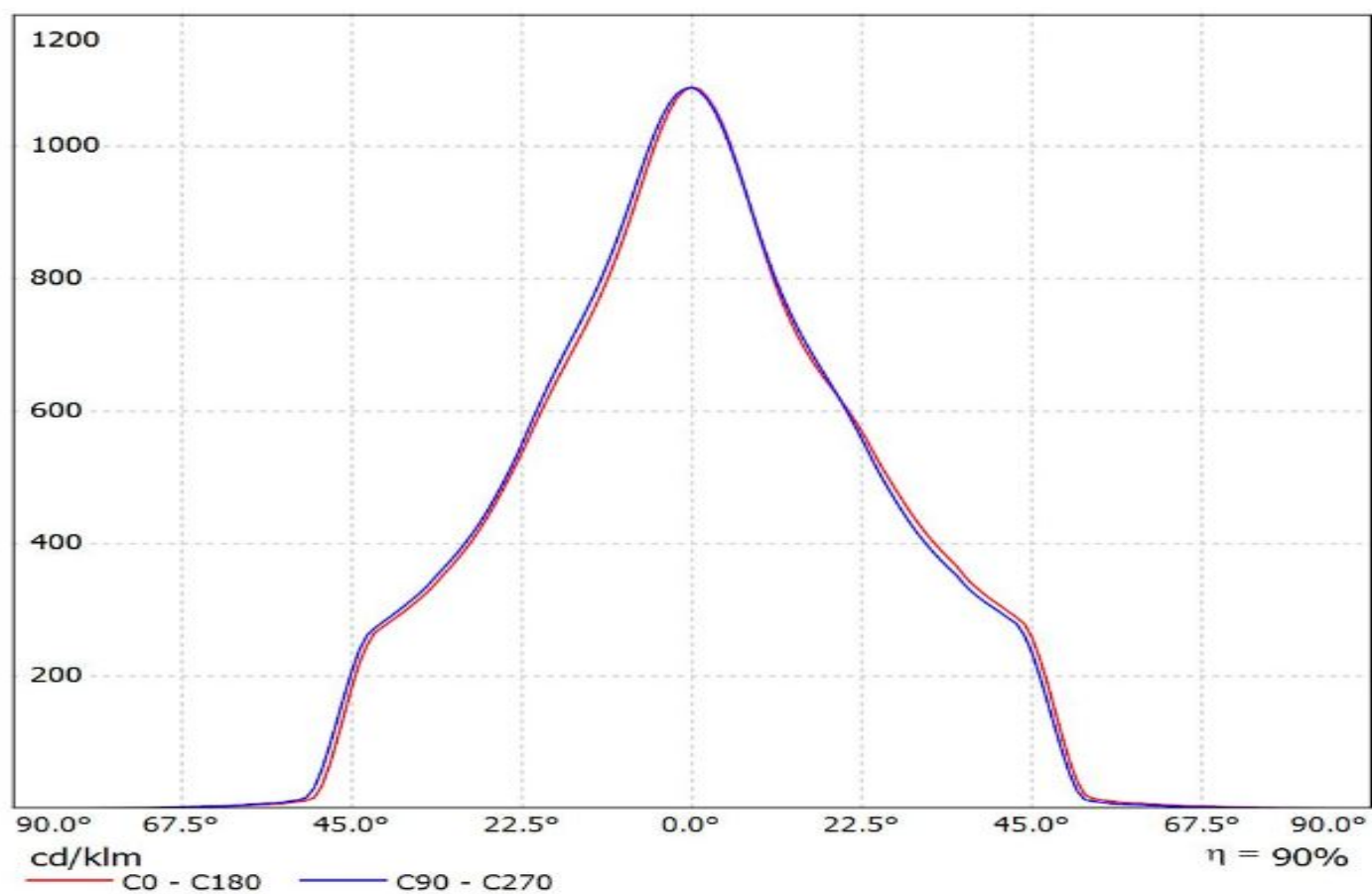

Luminaire: Ledil F13402_ANGELINA-W_(MJT_30W_Les14,5)_TE

Lamps: 1 x Seoul_MJT_30W_Les14,5mm_(SAWx1566A)_+TE_2213254-2+_TE_2213194-1_1328.6lm@250mA_P=8.24025W_I=0.25A

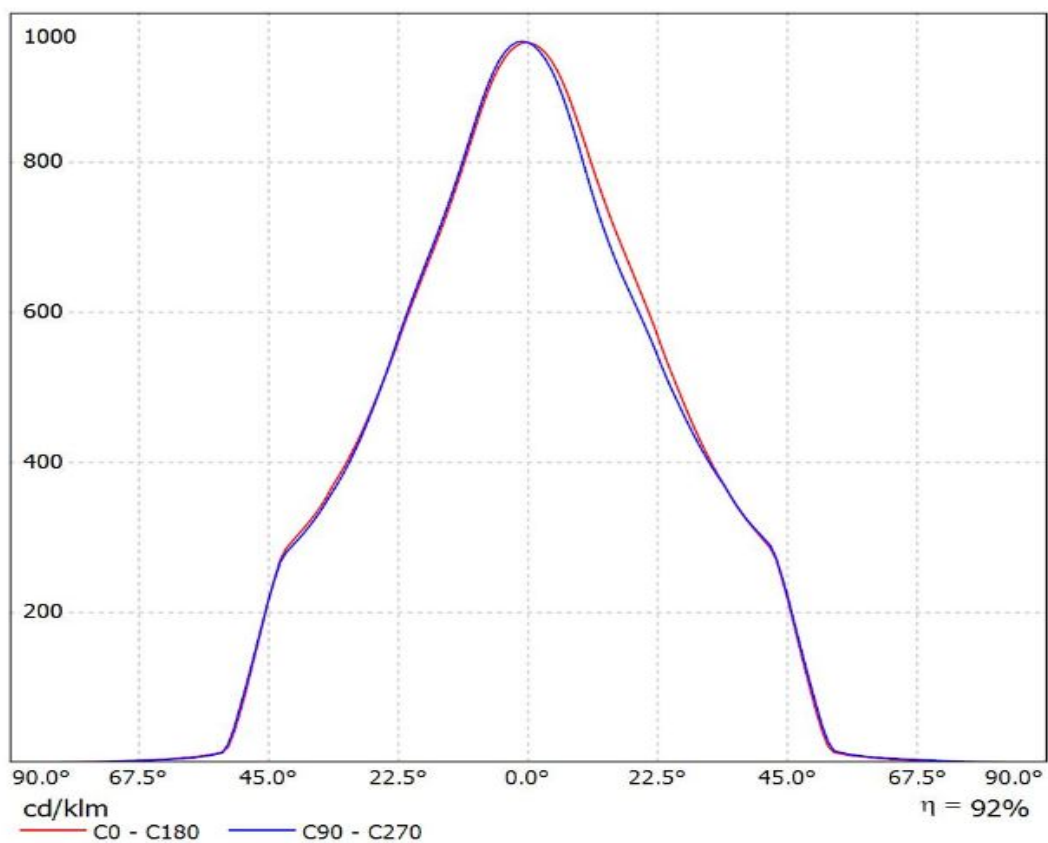

Luminaire: LEDiL Oy F13402_ANGELINA-W_(MegaZenigata) Eff.92.3%
Lamps: 1 x MegaZenigata_GW6DME (518.495lm@100mA)

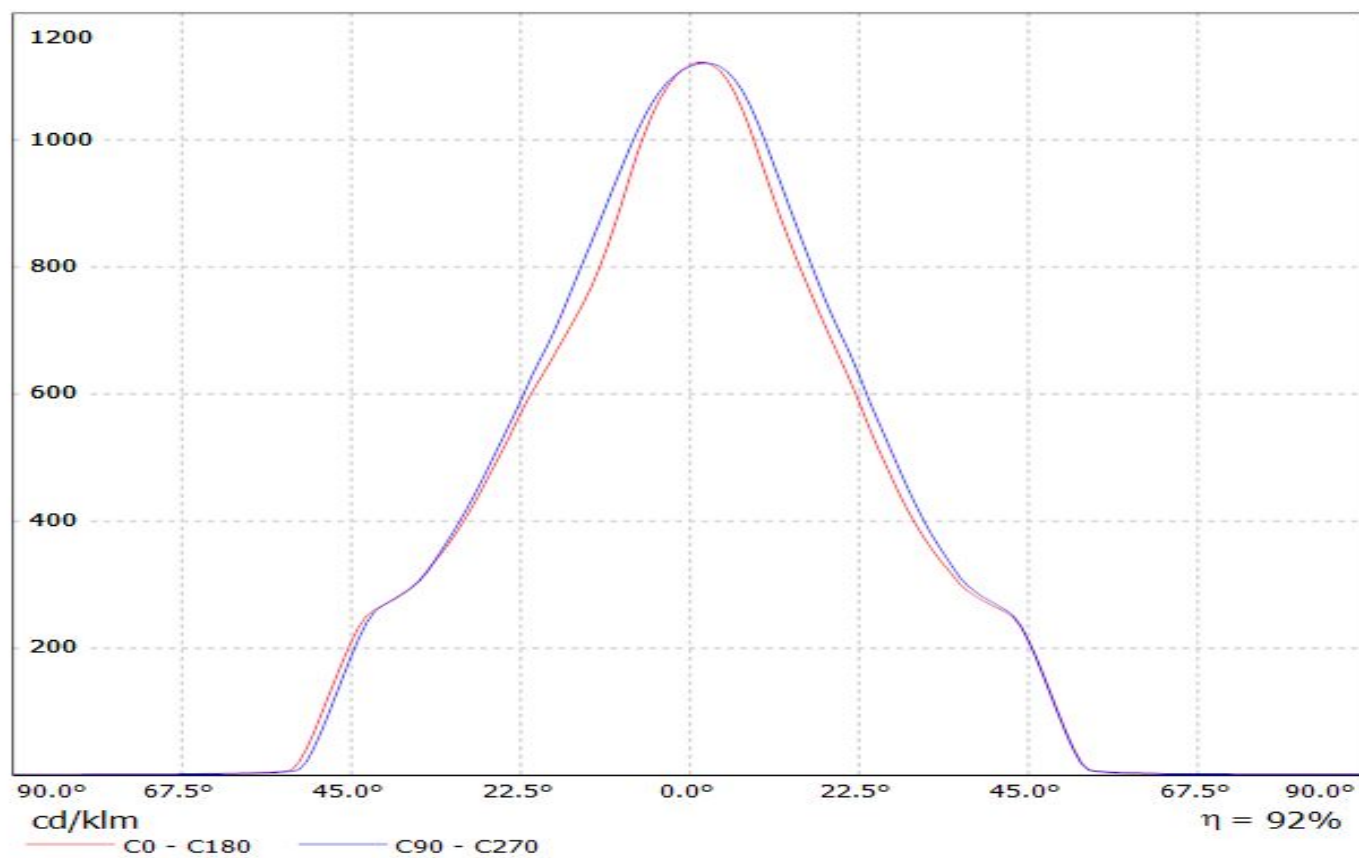

Luminaire: LEDiL Oy F13402_ANGELINA-W_(MEGAZENIGATA) Eff.93.0%
Lamps: 1 x SHARP_MEGAZENIGATA_(GW6DME30NFC)_1238.26lm@250mA_CCT=3000K_P=11.1211W_I=249.8mA

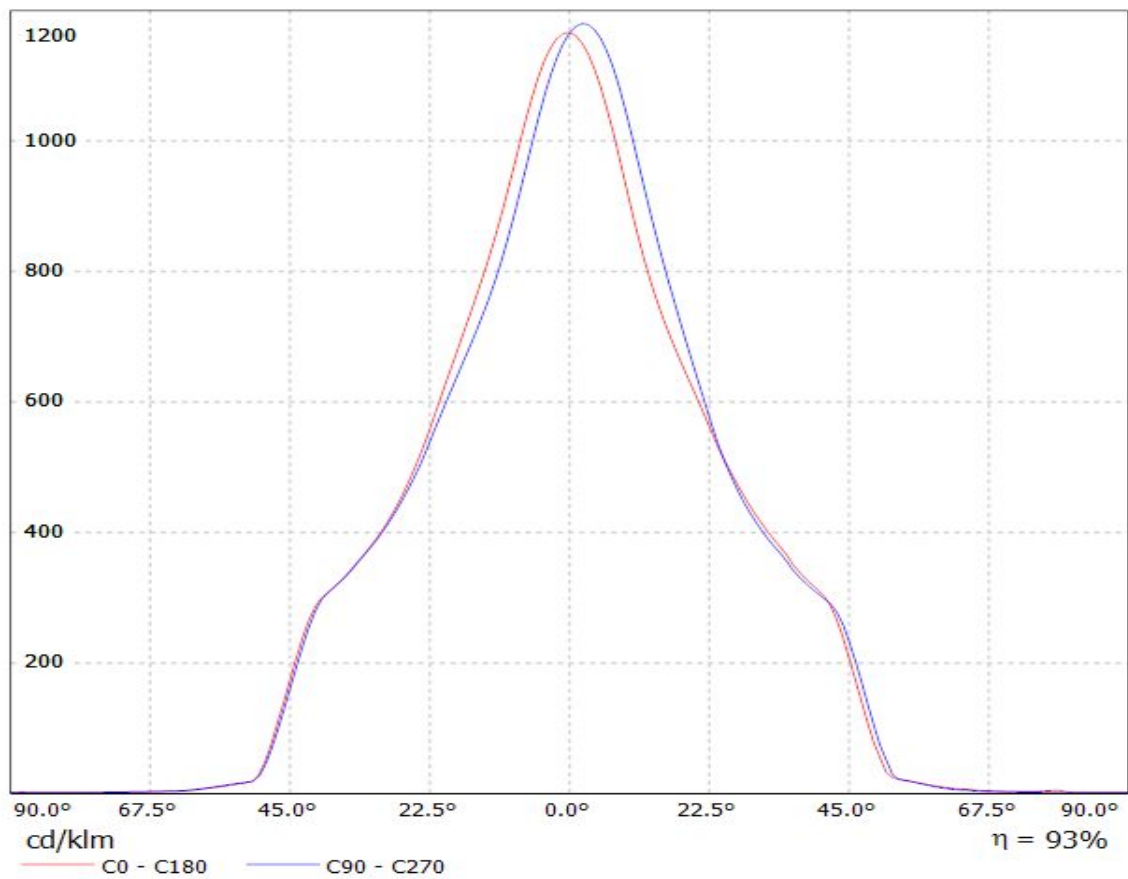

Luminaire: LEDiL Oy F13402_ANGELINA-W_(STARK_SLE_G2_LES19) Eff.91.5%
Lamps: 1 x TRIDONIC STARK SLE G2 LES19 830 CLA 964.643lm@250mA CCT=3000K P=8W I=250mA

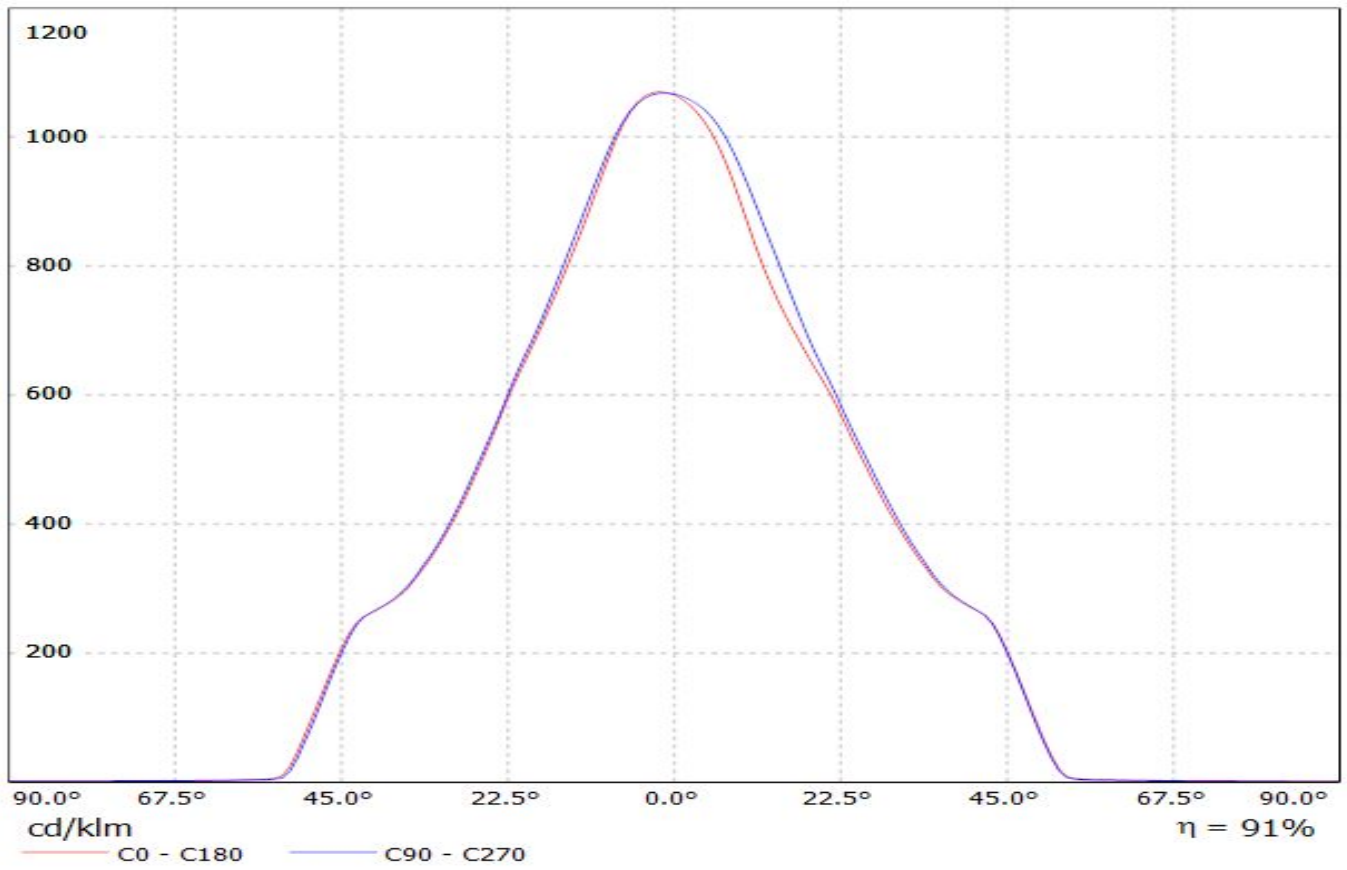

Luminaire: LEDiL Oy F13402_ANGELINA-W_(STARK_SLE_G2_LES23) Eff 90.2%
Lamps: 1 x TRIDONIC STARK SLE G2 LES23 830 CLA 982.73lm@250mA CCT=3000K P=8W I=250mA

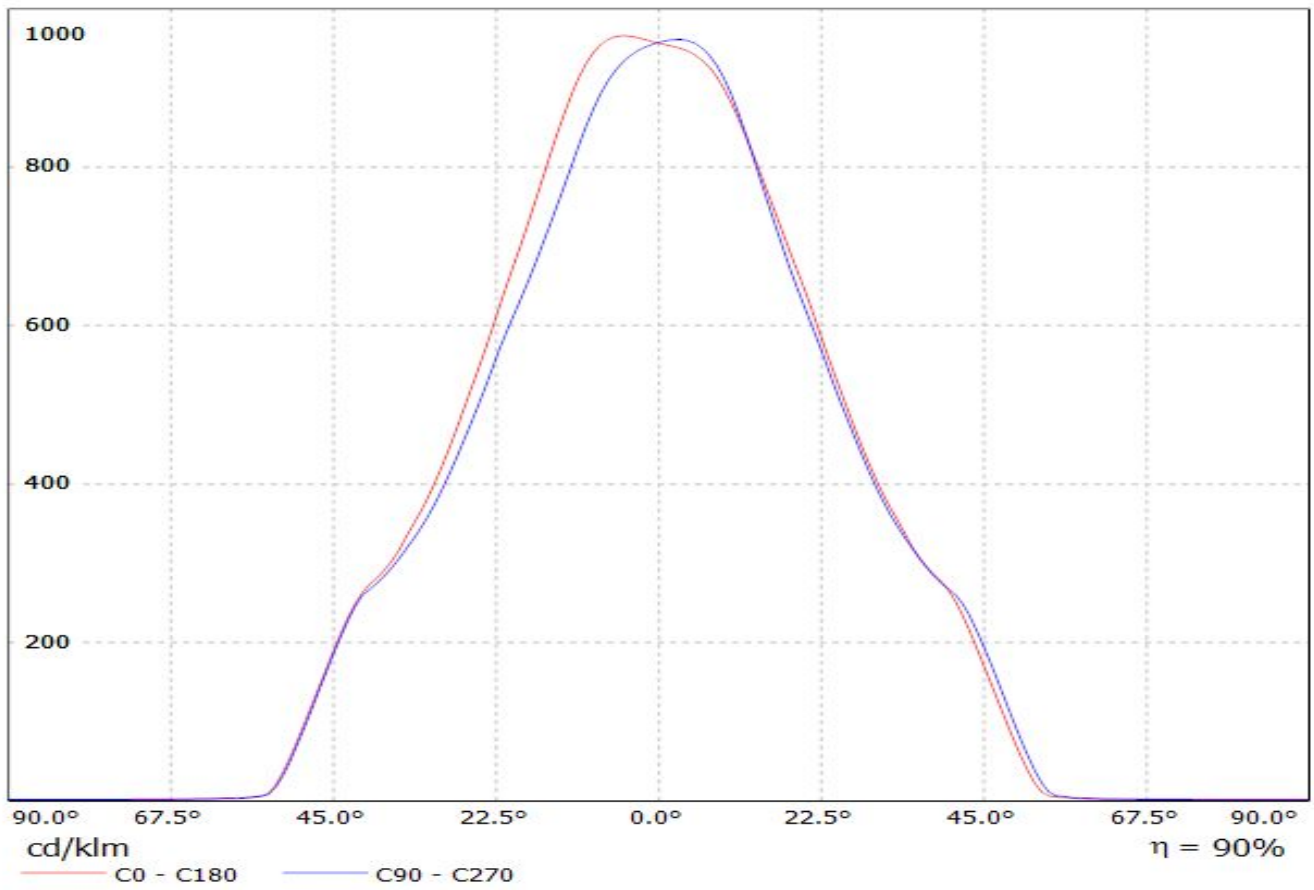

Luminaire: LEDiL Oy F13402_ANGELINA-W_(STARK_SLE_G2_LES26) Eff.89.0%
Lamps: 1 x TRIDONIC STARK SLE G2 LES26 830 CLA 1095.88lm@250mA CCT=3000K P=8W I=250mA

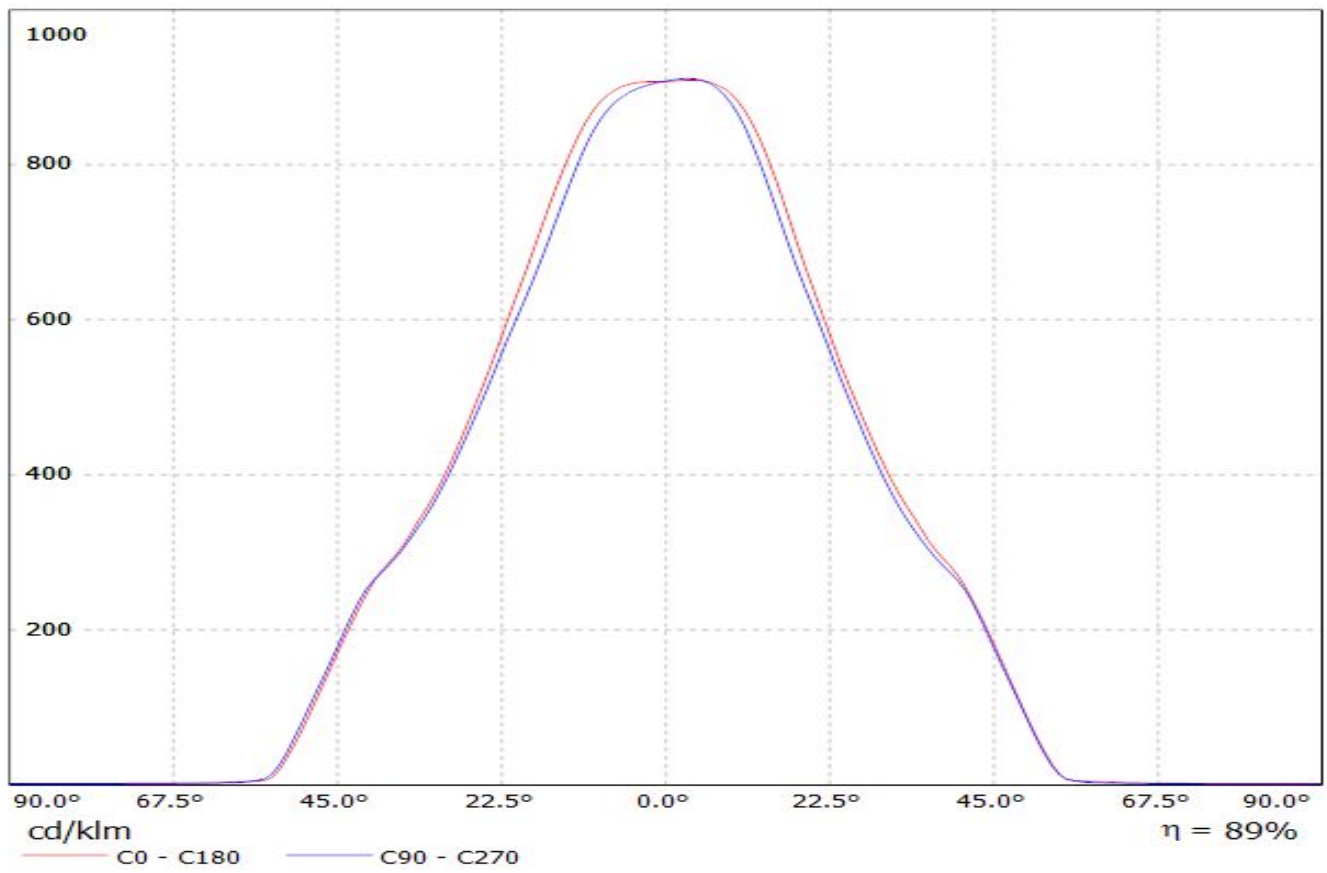

Luminaire: LEDiL Oy F13402_ANGELINA-W_(SLE_G3_LES19) Eff.92.2%

Lamps: 1 x TRIDONIC_STARK_SLE_G3_LES19_(STARK-SLE-G3-LES19-2000-840-CLA)_1058.33lm@250mA_P=8.32833W_I=249.8mA

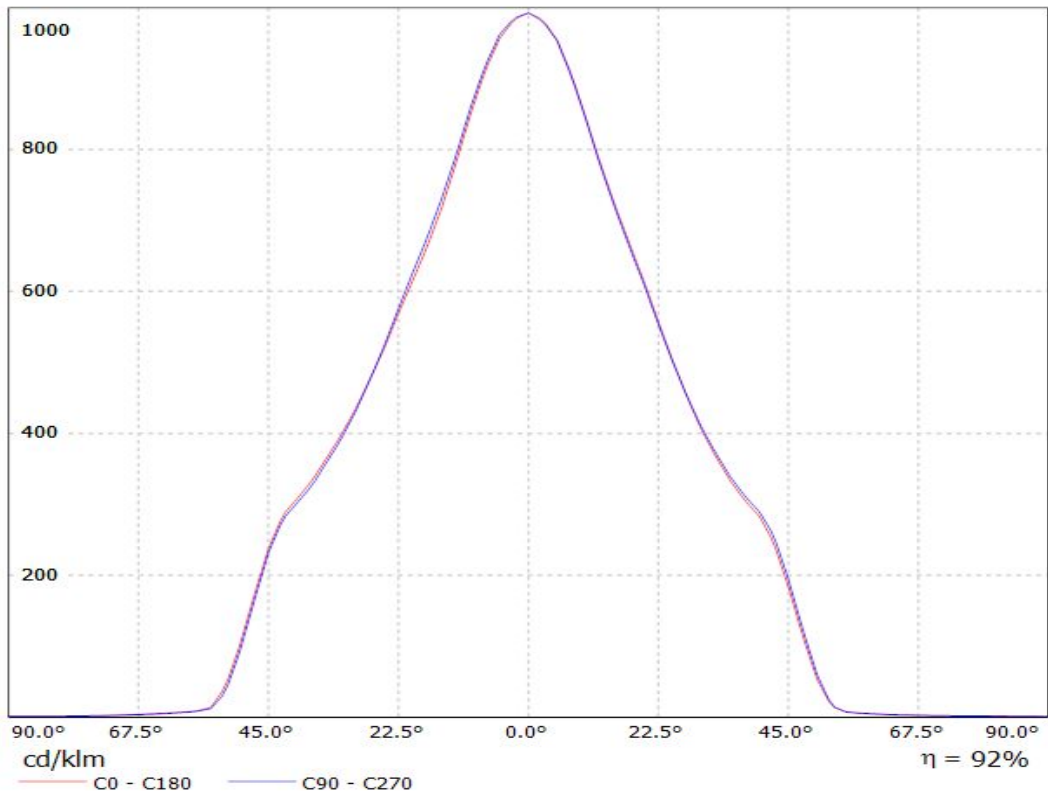

Luminaire: LEDiL Oy F13402_ANGELINA-W_(SLE_G3_LES23) Eff 90.3%

Lamps: 1 x TRIDONIC_STARK_SLE_G3_LES23_(STARK-SLE-PURE_G3-23-3000-930-SEL)_813.196lm@250mA_CCT=3000K_P=8.20018W_I=249.8mA

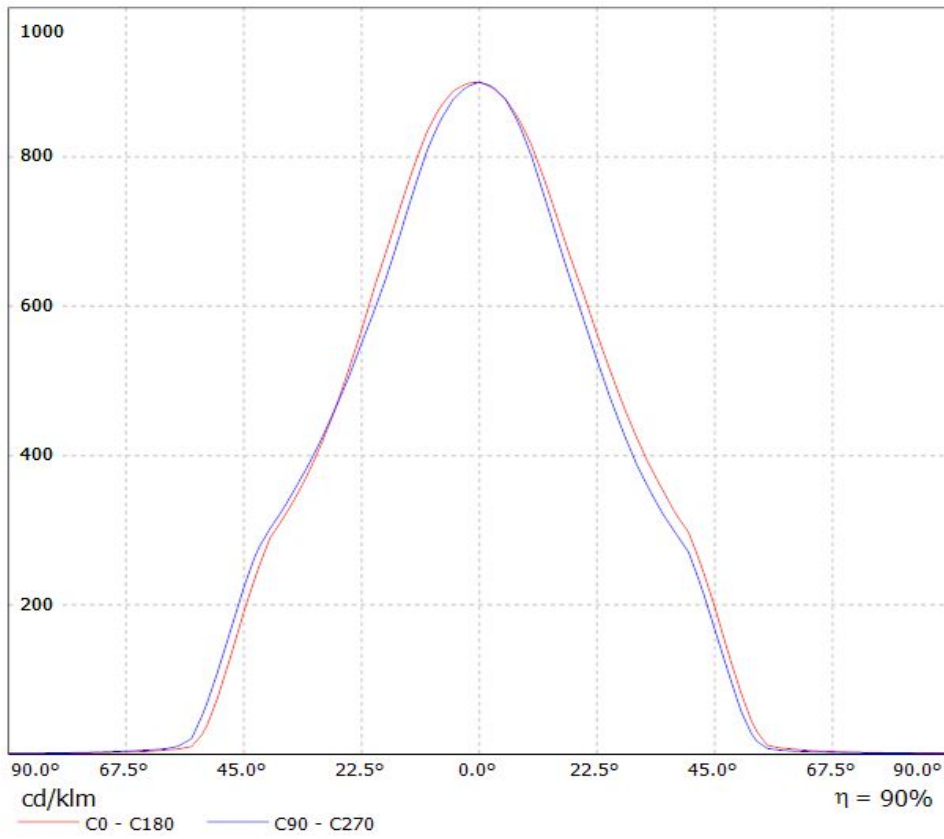

Luminaire: LEDiL Oy F13402_ANGELINA-W_(SLE_G4_LES23)
Lamps: 1 x Tridonic_SLE_G4_LES23_1354.57lm@250mA_P=8.18744W_I=0.2498A

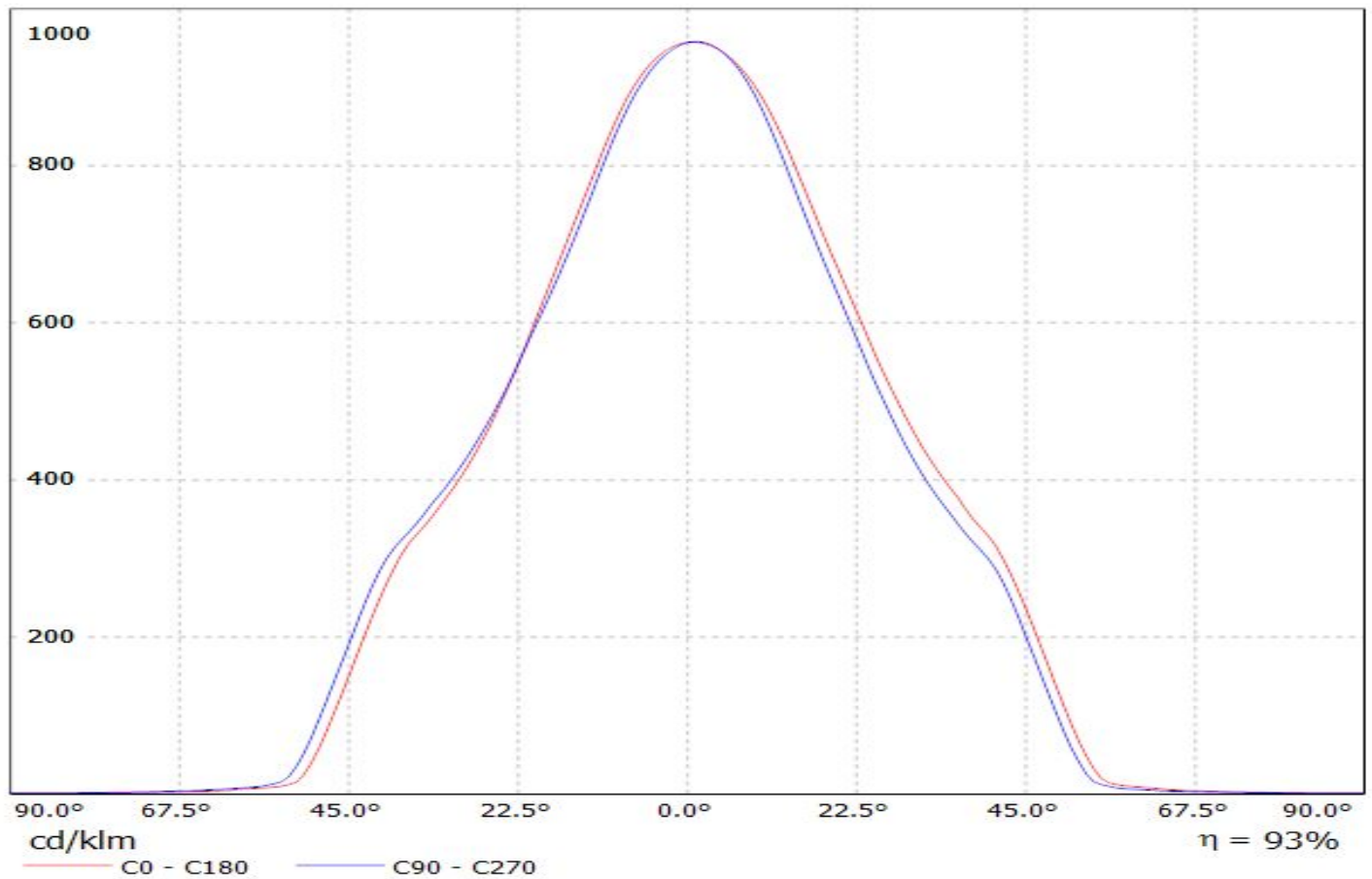

Luminaire: LEDiL Oy F13402_ANGELINA-W_(SLE GEN4 LES19)
Lamps: 1 x SLE GEN4 LES19_1226.28lm@250mA_P=8.21367W_I=0.2498A

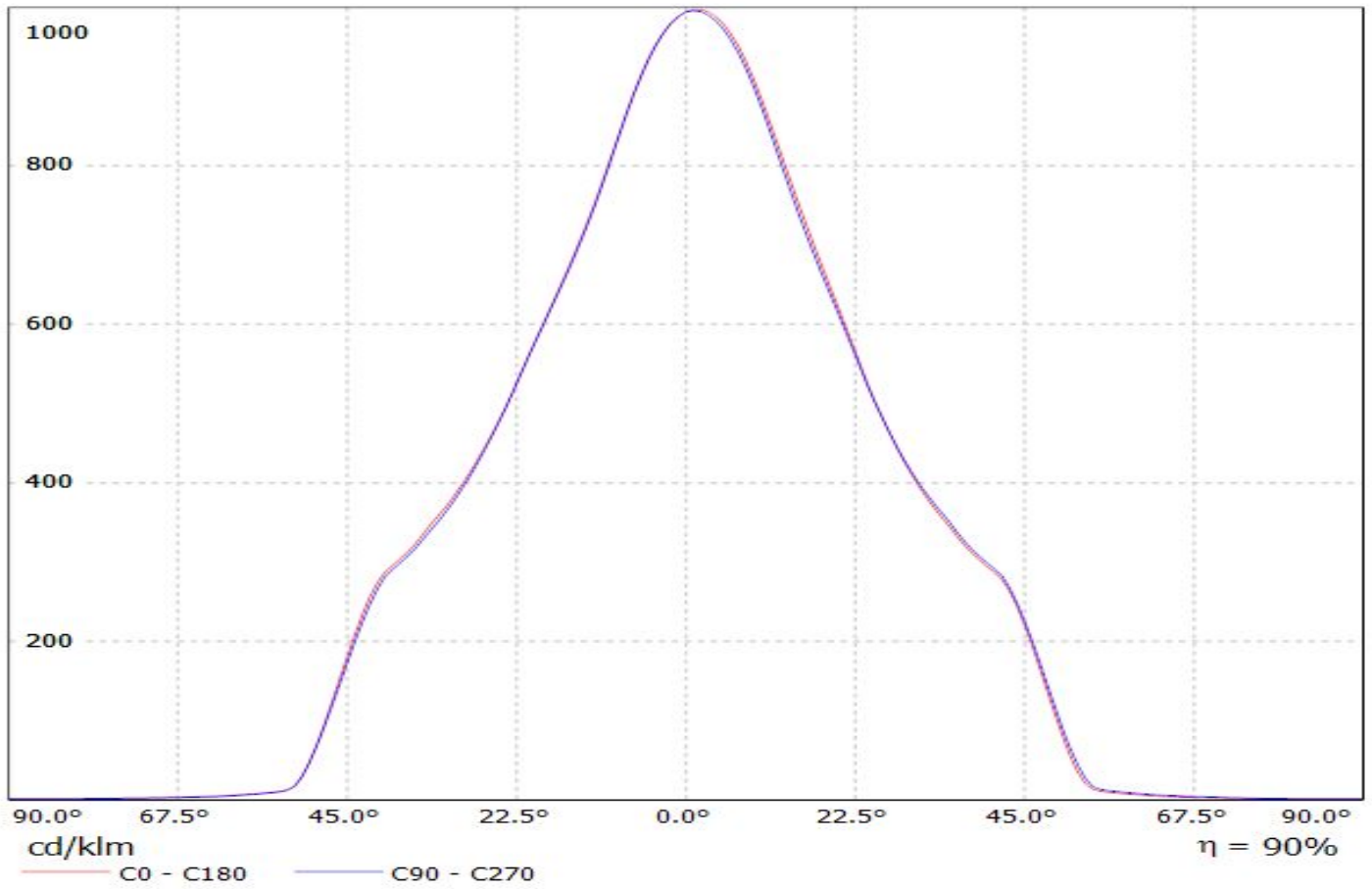

Luminaire: LEDiL Oy F13402_ANGELINA-W_(SLE-G5_LES-15)
Lamps: 1 x Tridonic_SLE-G5_LES-15_1247.09lm@250mA_P=8.6730W_I=0.250A

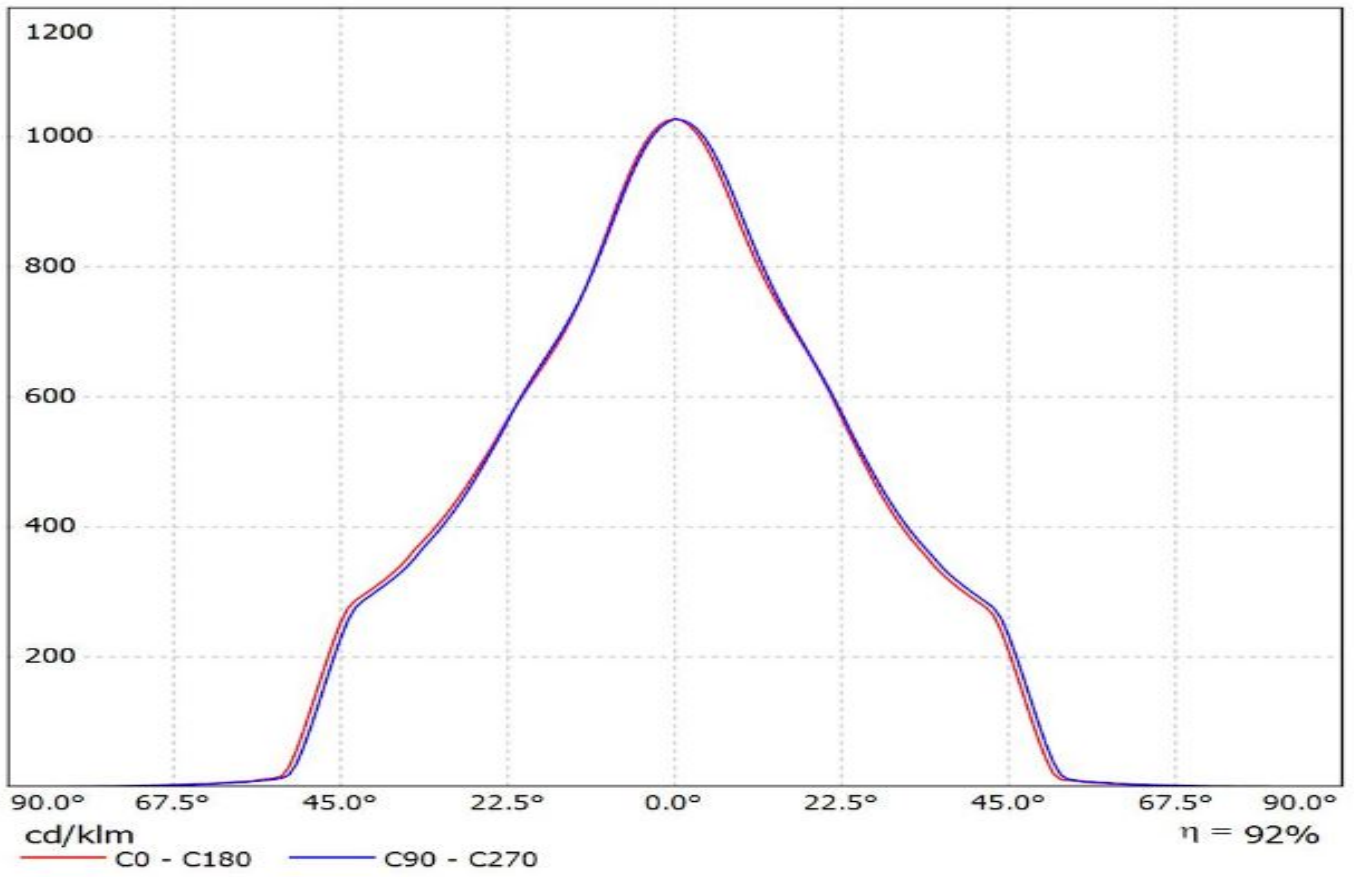

Luminaire: LEDiL Oy F13402_ANGELINA-W (SLE-G5_LES-19)

Lamps: 1 x Tridonic_SLE-G5_LES-19_1287.79lm@250mA_P=8.2274W_I=0.250A

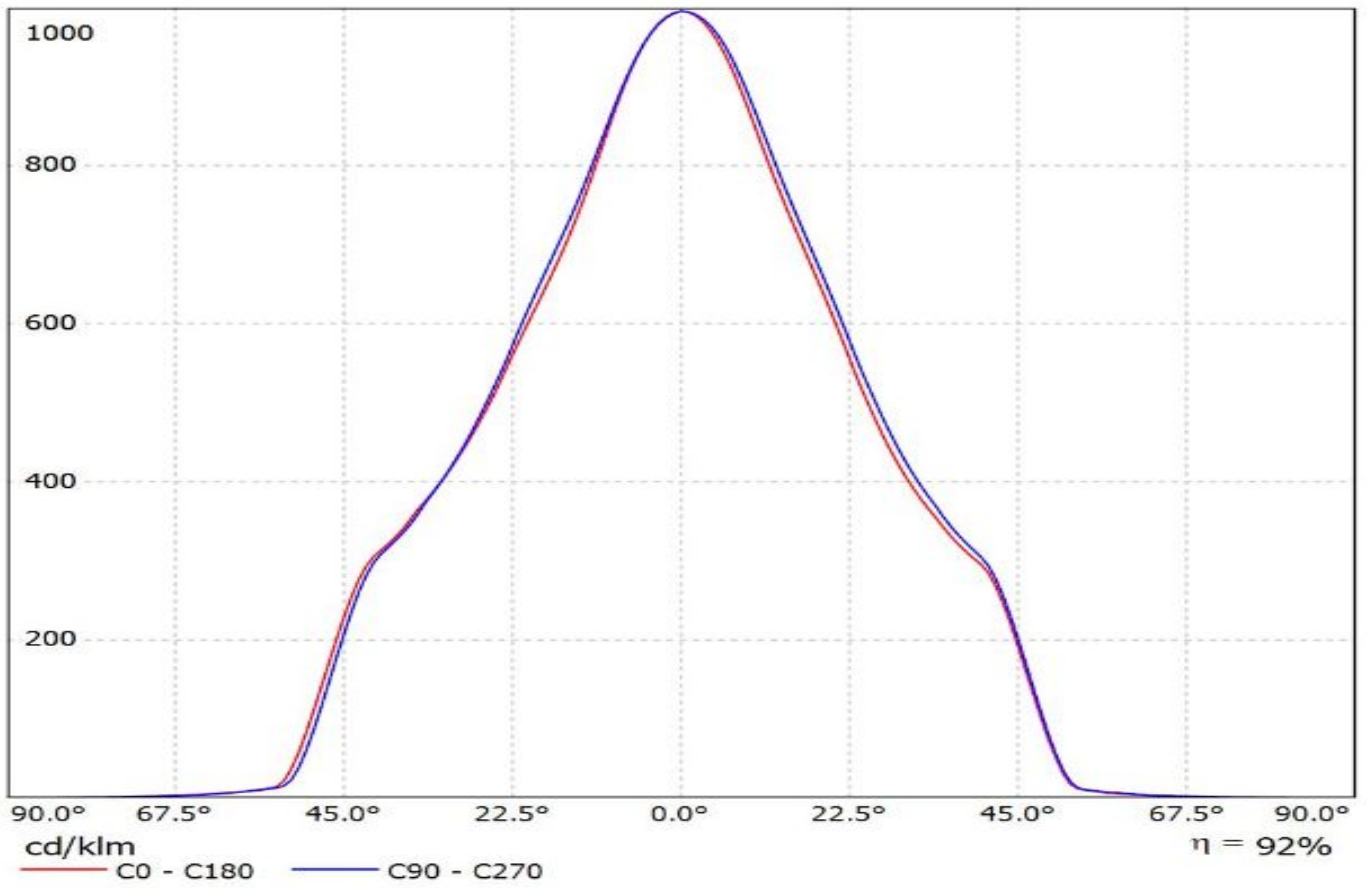

Luminaire: LEDiL Oy F13402_ANGELINA-W_(SLE-G5_LES-23)
Lamps: 1 x Tridonic_SLE-G5_LES-23_1303.96lm@250mA_P=8.1062W_I=0.250A

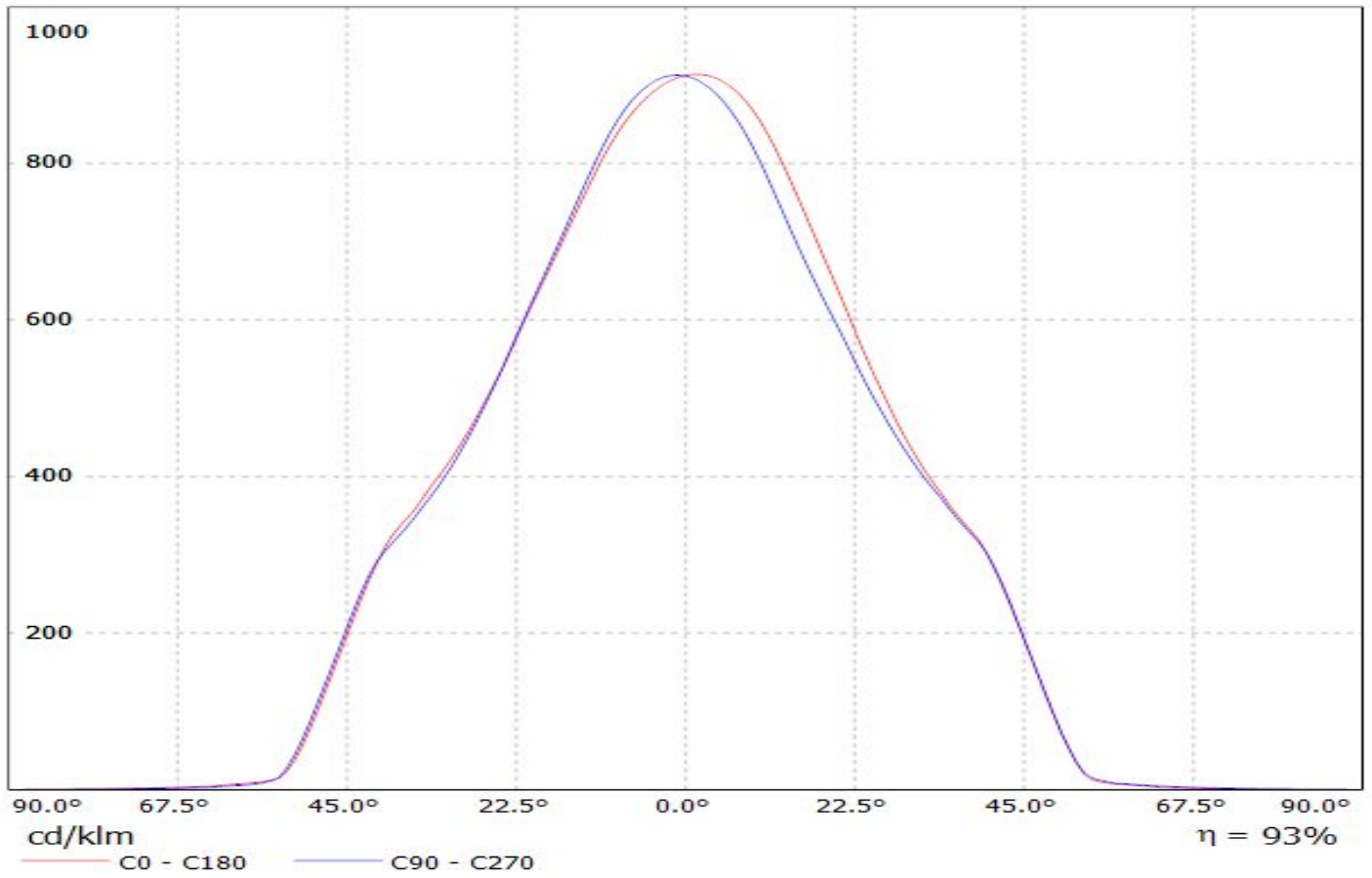

Luminaire: Ledil Oy F13402_ANGELINA-W_(SLE_G6_LES15)_(2213254-2_+_2213194-1)_SIMULATED
Lamps: 1 x Tridonic SLE G5 LES15 + Tyco Electronics 2213254-2 + TE 2213194-1 optic clip

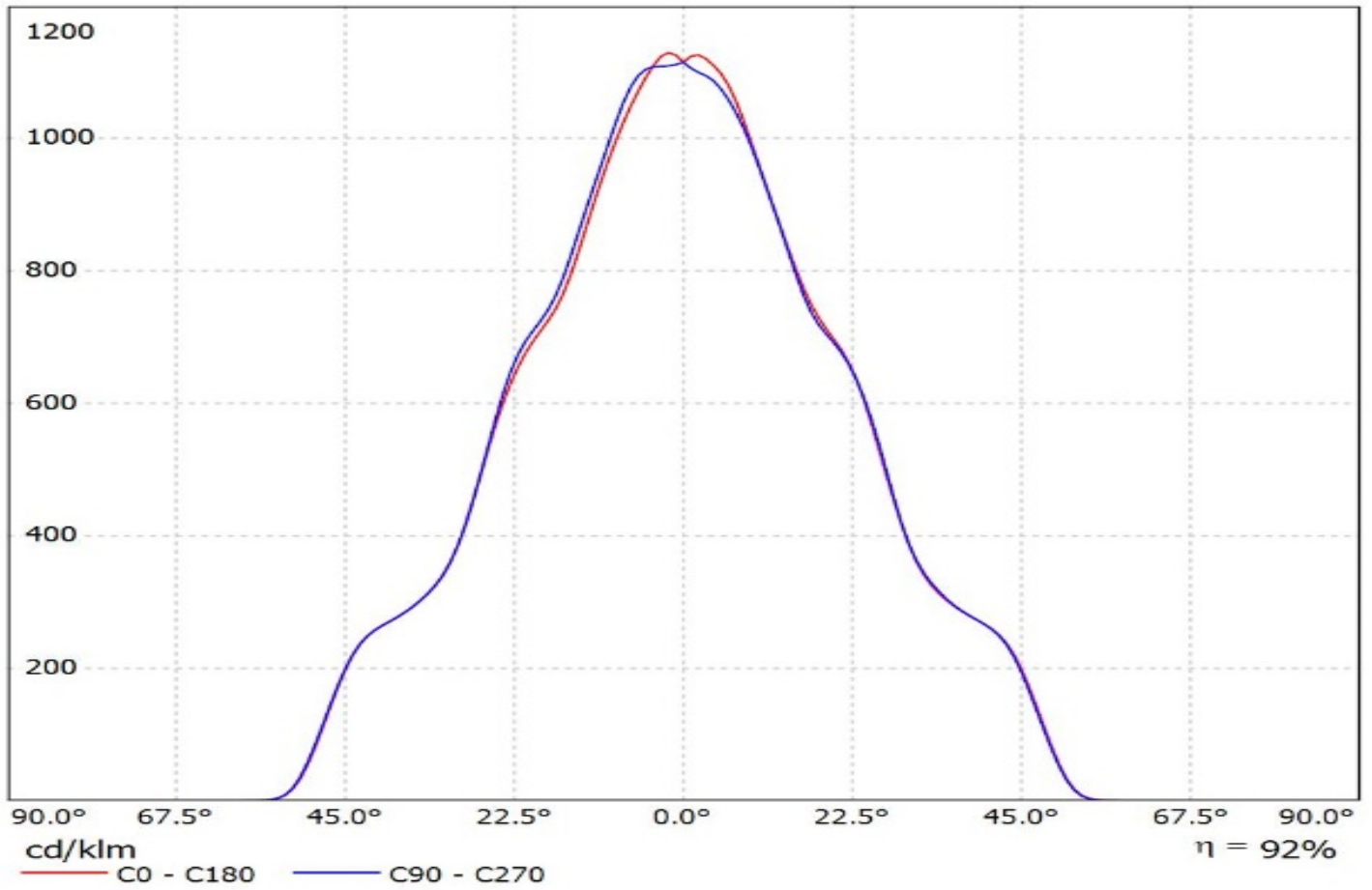

Luminaire: Ledil Oy F13402_ANGELINA-W+_TE_2213254-2+_TE_Z50_Type1_TRIDONIC_SLE_G6_LES17_SIMULATED
Lamps: 1 x TRIDONIC SLE G6 LES17

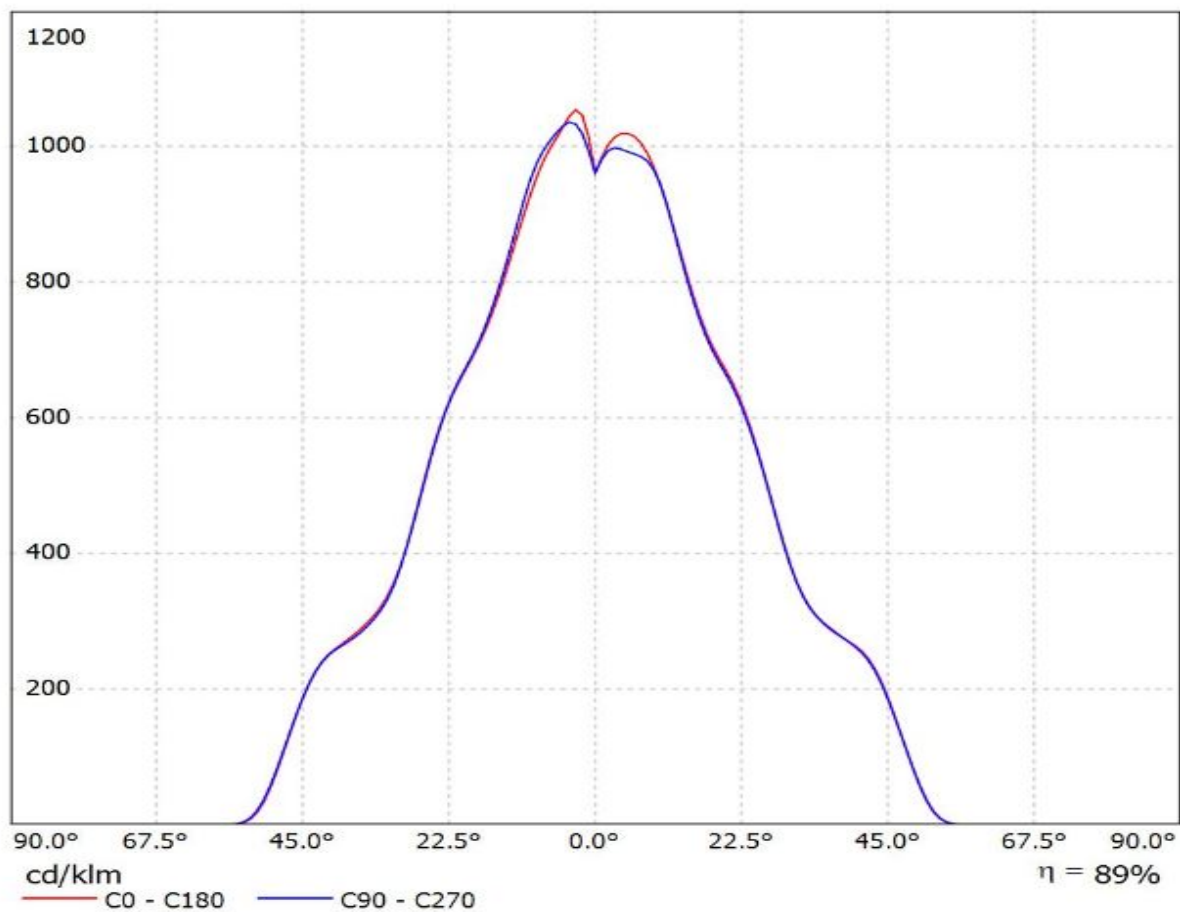

Luminaire: LEDiL Oy F13402_ANGELINA-W_(WU-M-461-827)
Lamps: 1 x Vossloh_WU-M-461-827_773.276lm@250mA_P=6.27423W_I=249.8mA

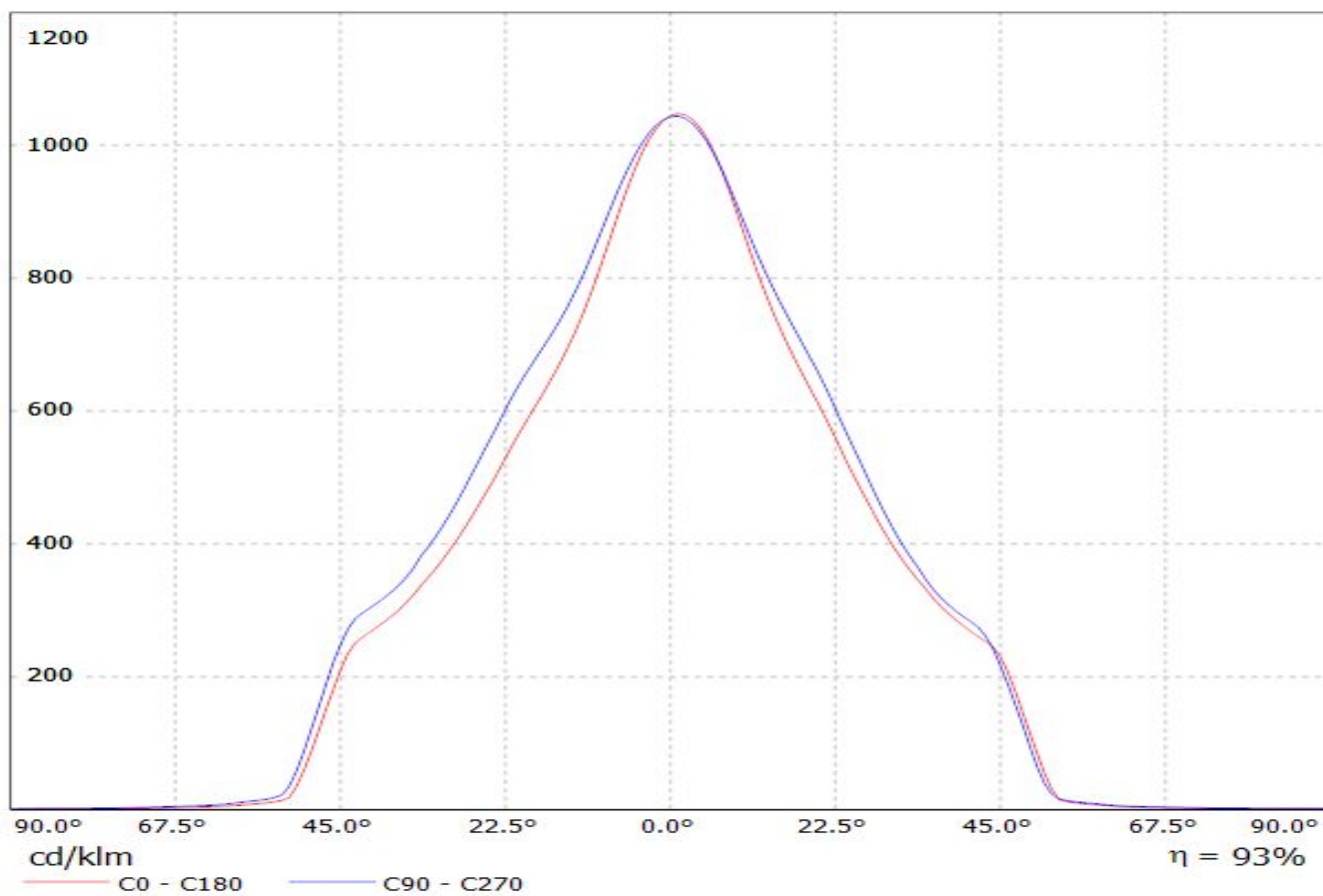

Luminaire: LEDiL Oy F13402_ANGELINA-W_(WU-M-462-827)

Lamps: 1 x Vossloh_WU-M-462-827_1116.7lm@250mA_P=8.9943W_I=249.8mA

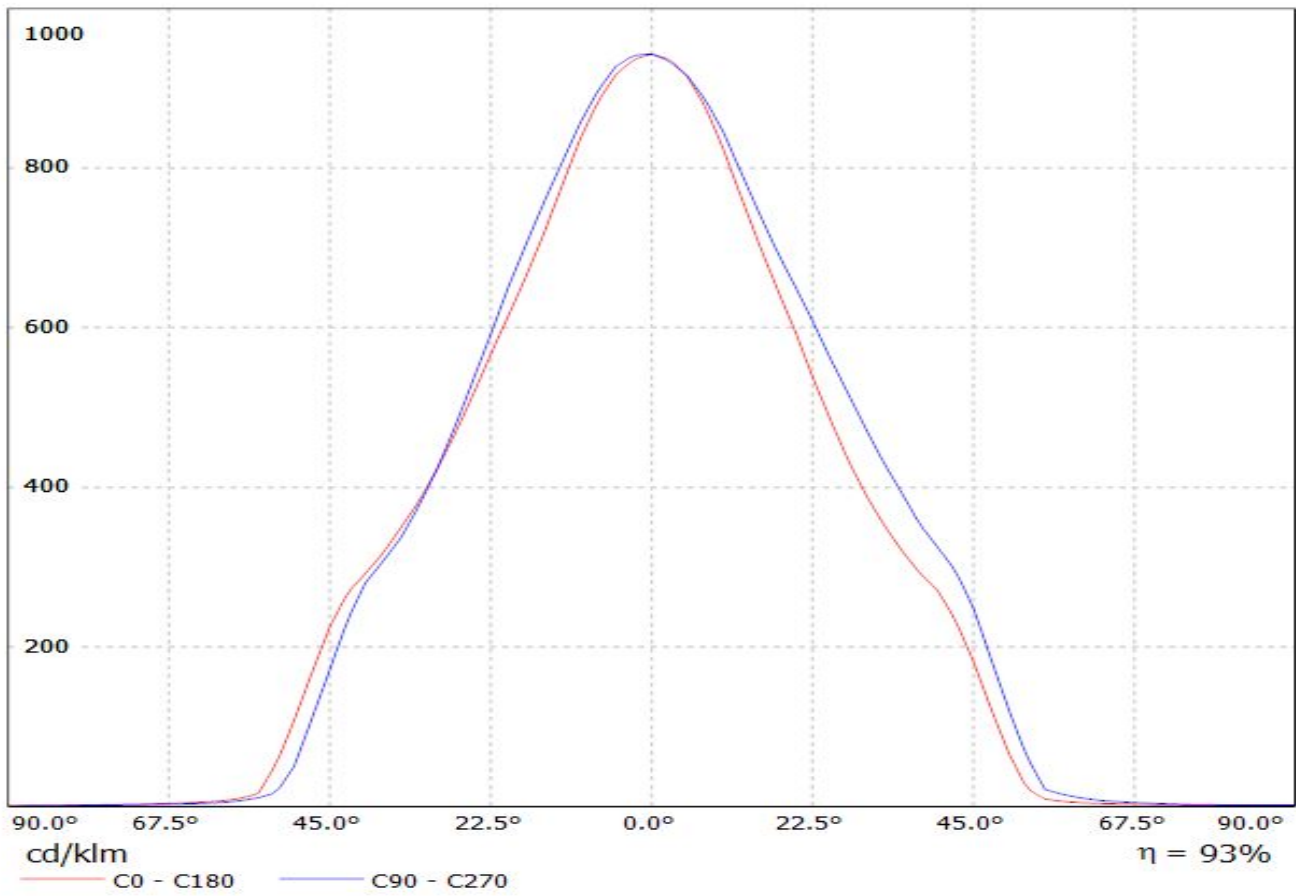

Luminaire: LEDiL Oy F13402_ANGELINA-W_(WU-M-464-827)

Lamps: 1 x Vossloh_WU-M-464-827_1452.93lm@250mA_P=11.6939W_I=249.8mA

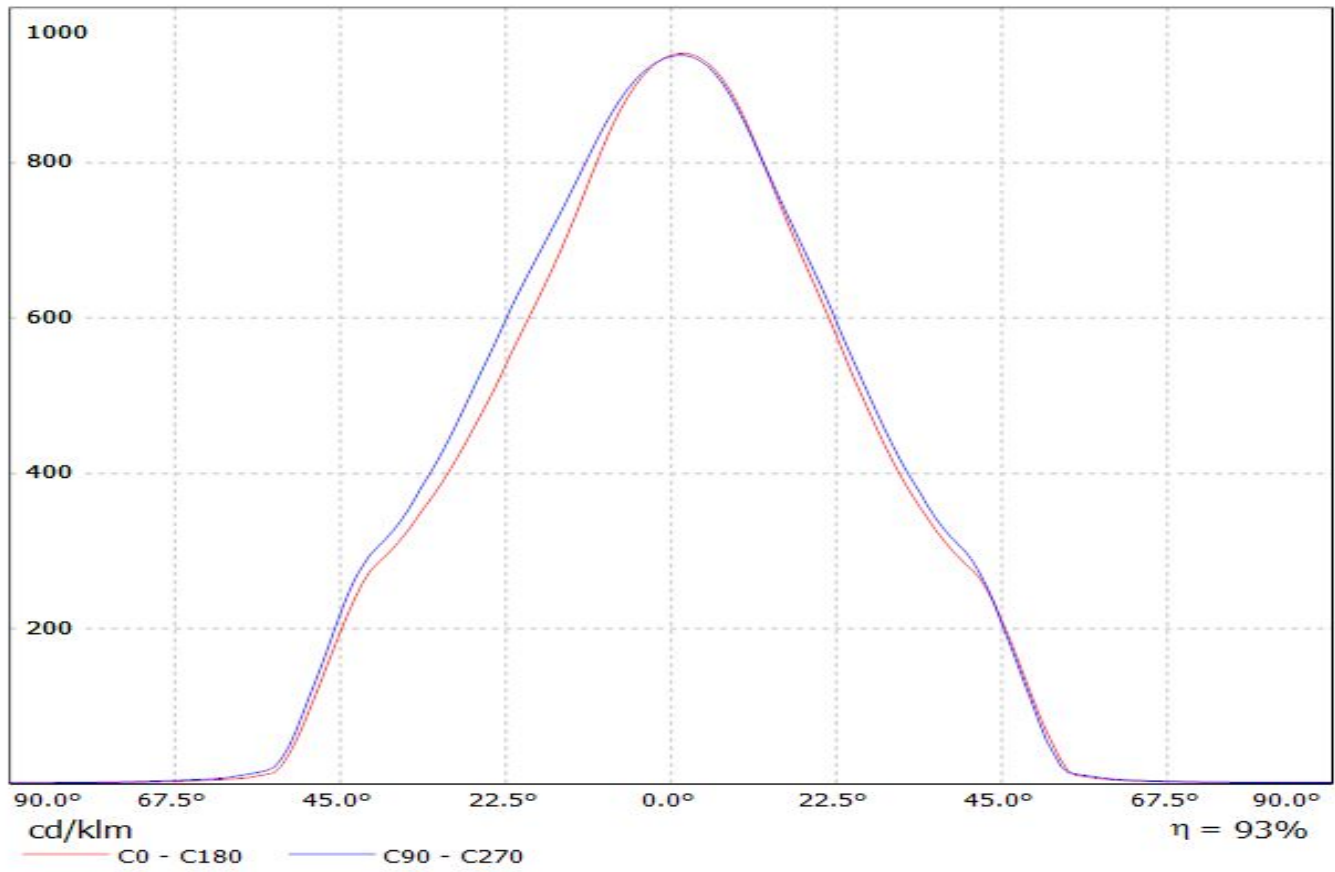

Luminaire: LEDiL Oy F13402_ANGELINA-W_(WU-M-484)

Lamps: 1 x Vossloh_Schwabe-WU-M-484_(WU-M-484-830)_657.125lm@250mA_P=5.59976W_I=249.9mA

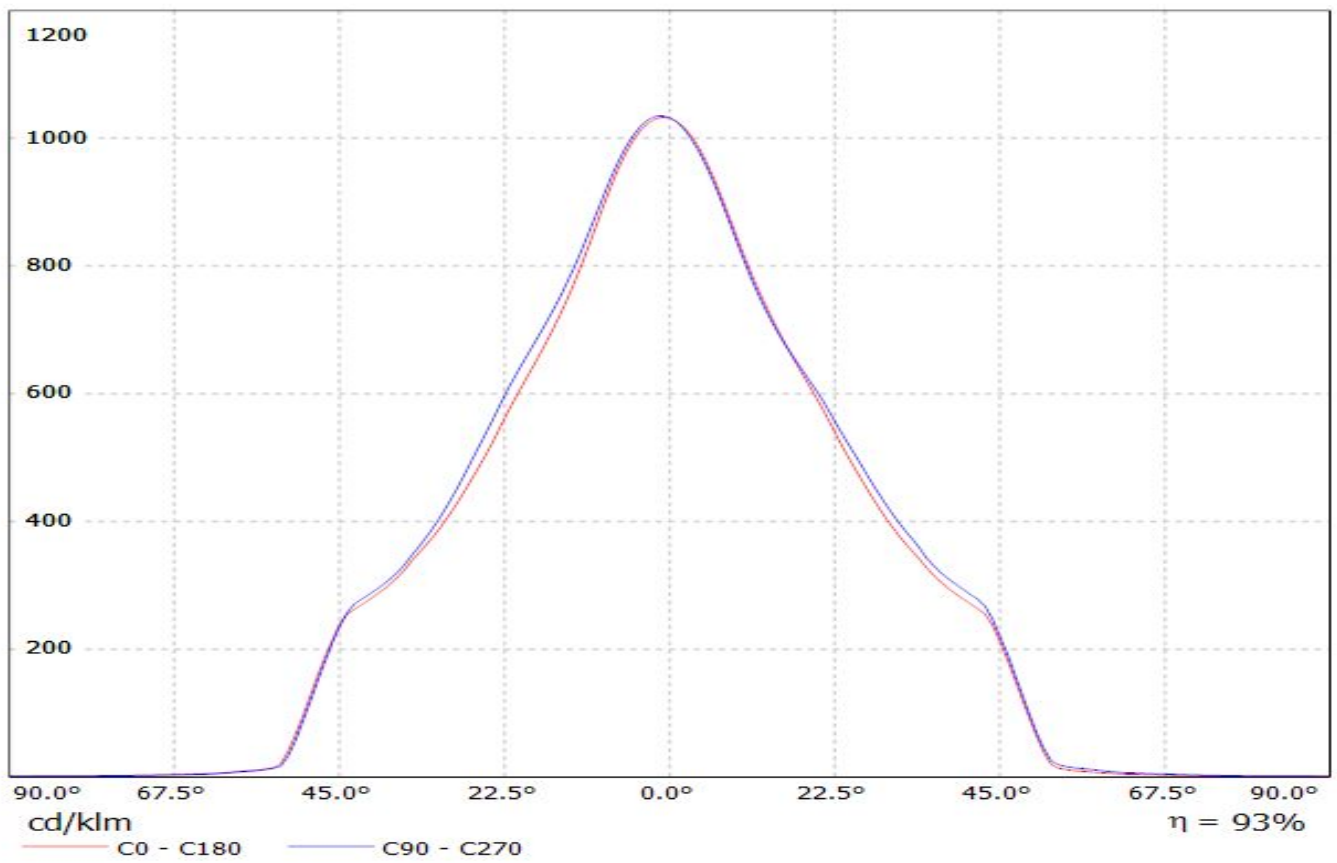

Luminaire: LEDiL Oy F13402_ANGELINA-W_(WU-M-484)

Lamps: 1 x Vossloh_Schwabe-WU-M-485_(WU-M-485-830)_1209.62lm@250mA_P=8.43849W_I=249.8mA

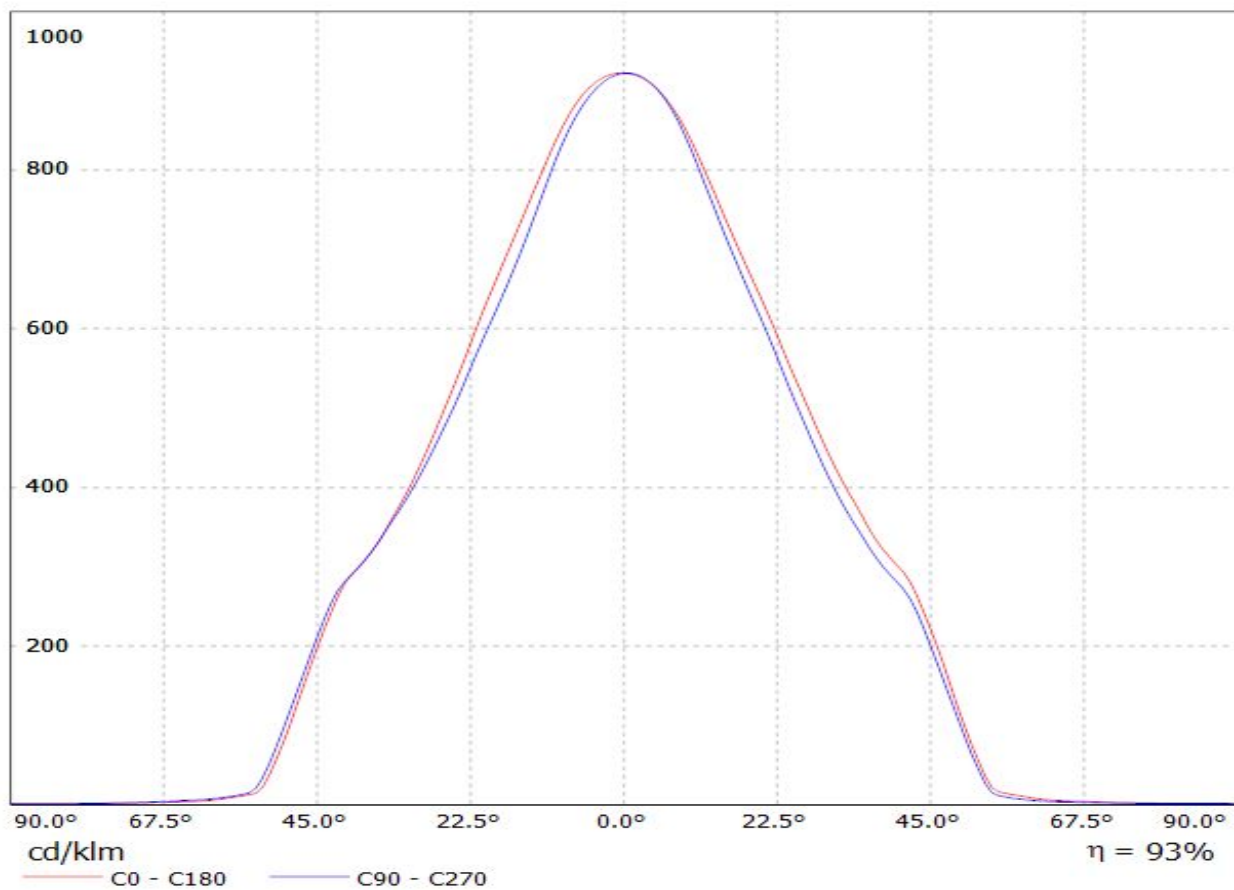

Luminaire: LEDiL Oy F13402_ANGELINA-W_(WU-M-486) Eff.92.5%
Lamps: 1 x Vossloh_Schwabe-WU-M-486_(WU-M-486-830)
_1474.55lm@250mA_P=10.4456W_I=249.8mA

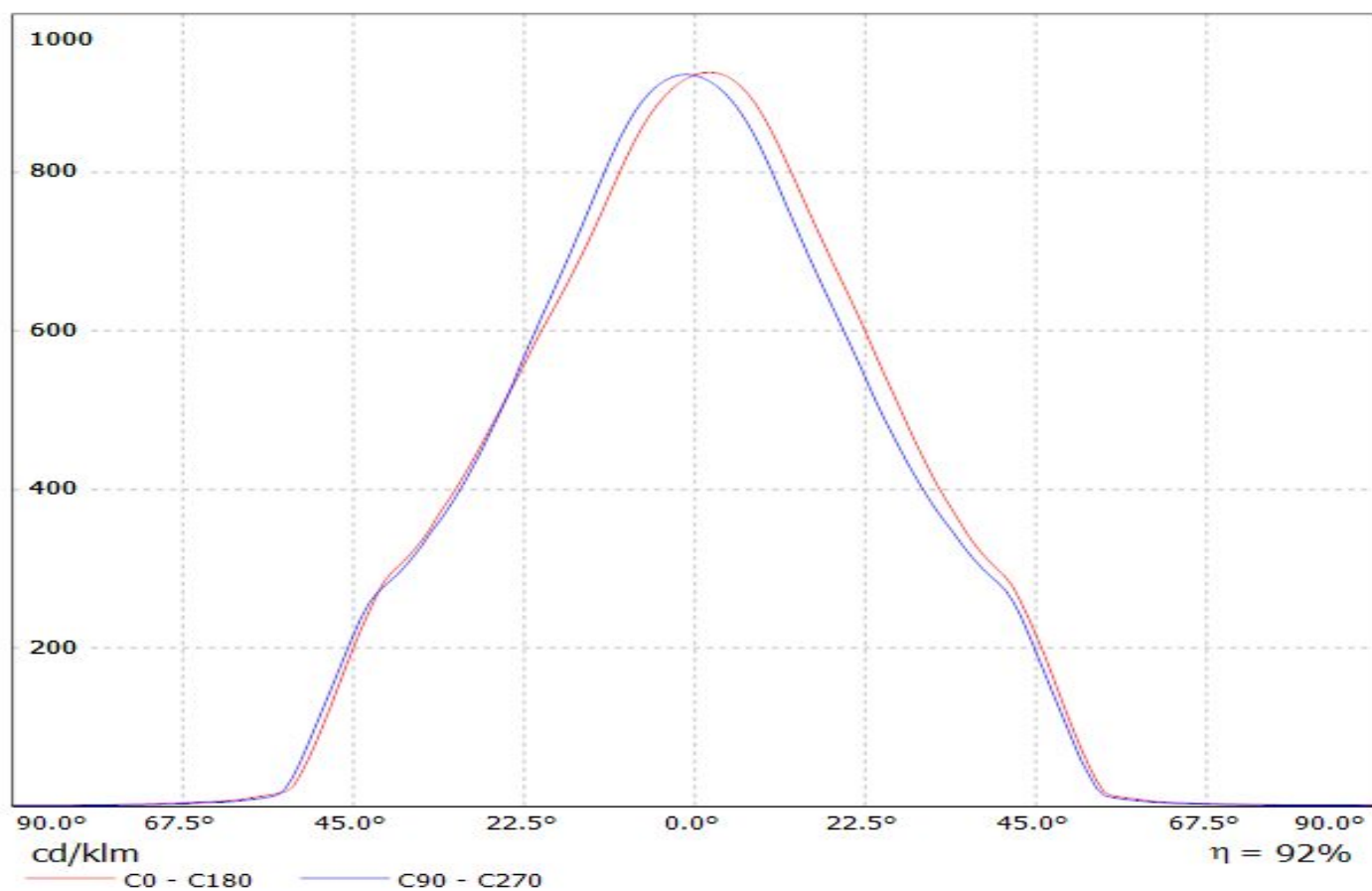

Luminaire: LEDiL Oy F13402_ANGELINA-W_(MEGAZENIGATA) Eff.93.0%

Lamps: 1 x SHARP_MEGAZENIGATA_(GW6DME30NFC)_1238.26lm@250mA_CCT=3000K_P=11.1211W_I=249.8n

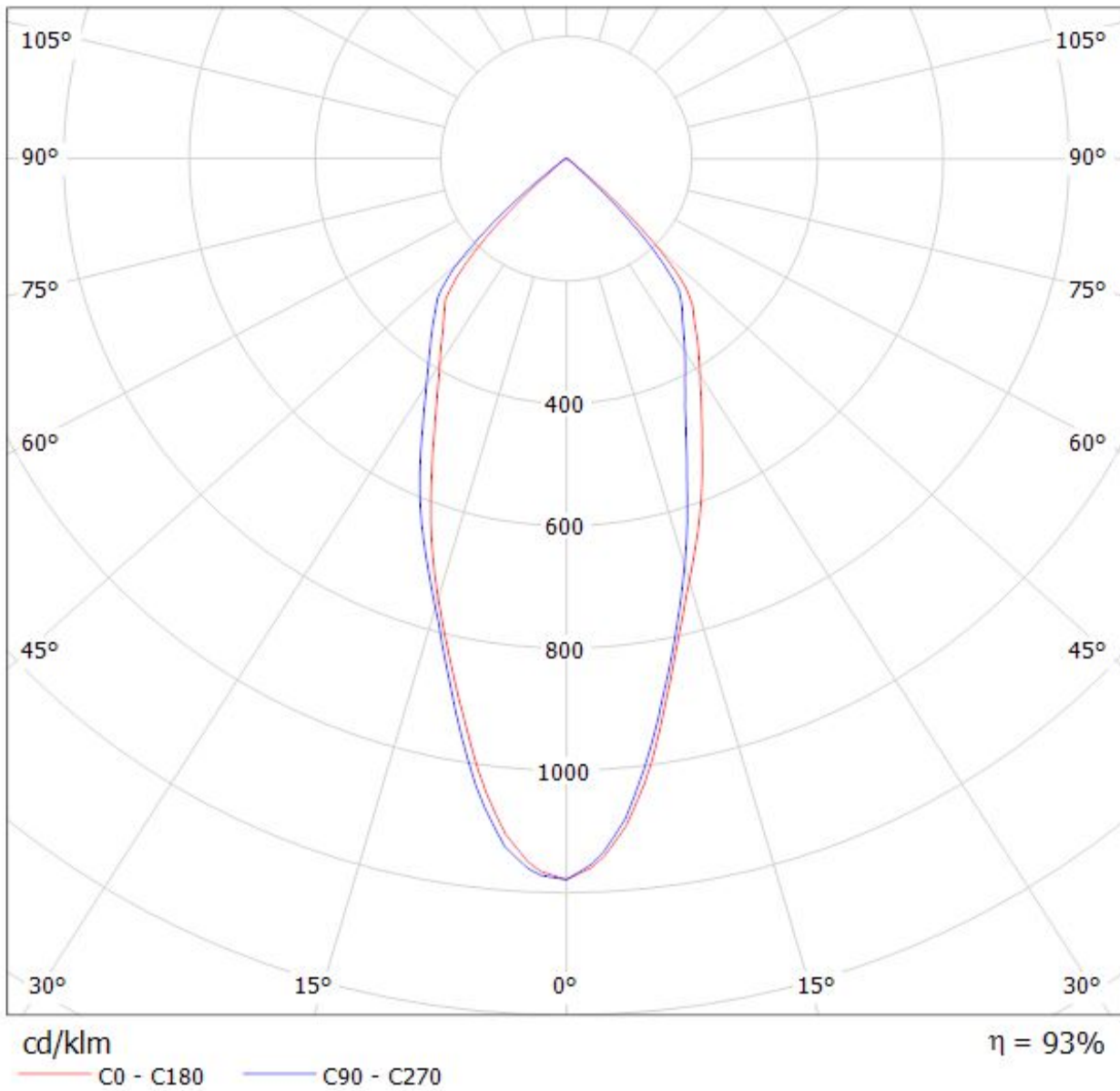

Luminaire: Ledil F13402_ANGELINA-W_(V22+IDEAL)

Lamps: 1 x Bridgelux_V22_(BXRE30E6500H-Y2)_+50-2204CT_+_50-2100AN_1193.54lm@250mA_CCT=3000K_P=8.0988W_I=0.25A

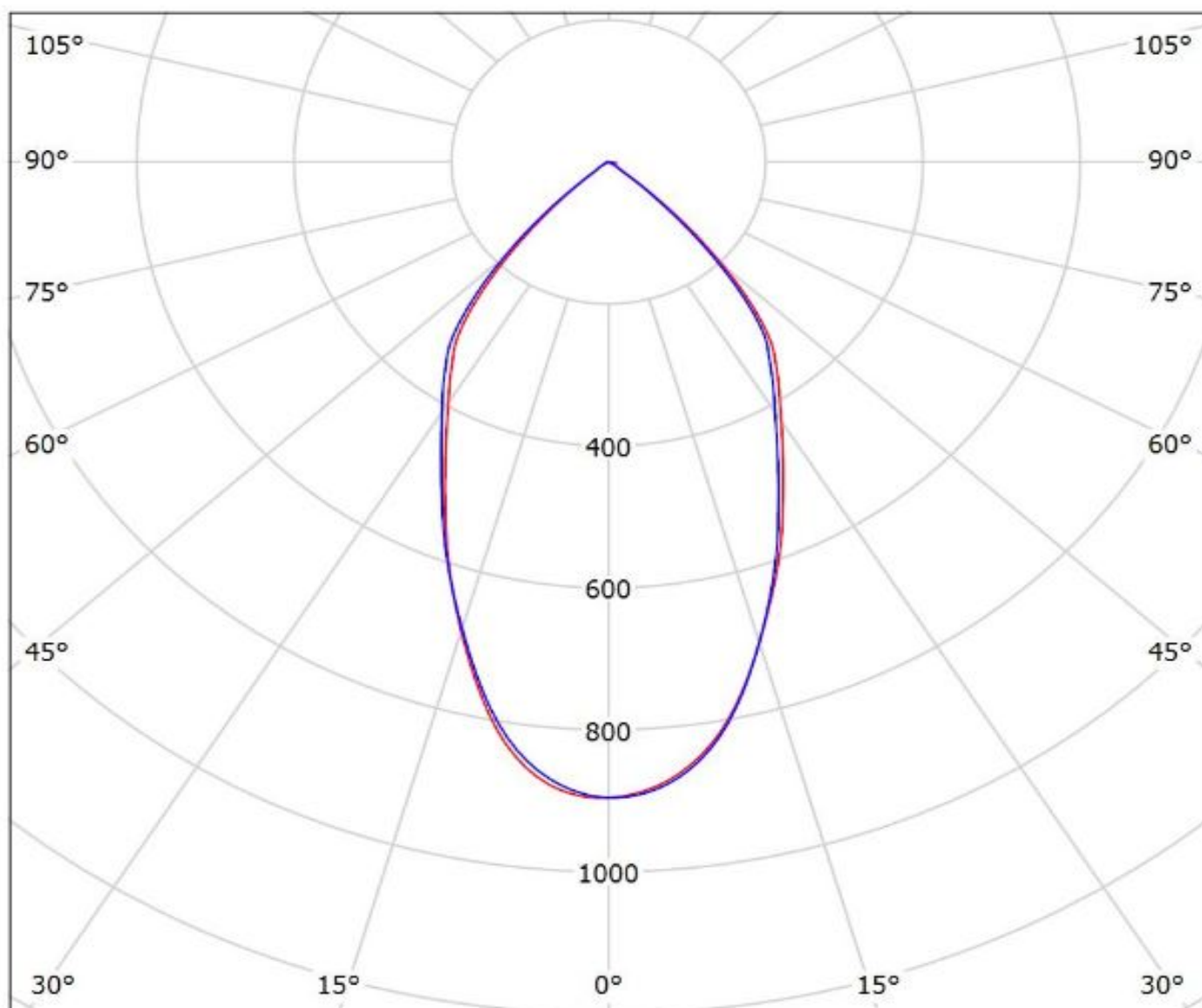

cd/klm

— C0 - C180

— C90 - C270

$\eta = 92\%$

Luminaire: LEDiL Oy F13402_ANGELINA-W_(V13_Gen7)+TE

Lamps: 1 x Bridgelux_V13_Gen7_(BXRE-30E2000-B_+TE_2213254-2+TE_2213194-1)_1295.55lm@250mA_P=8.30985W_I=0.25A

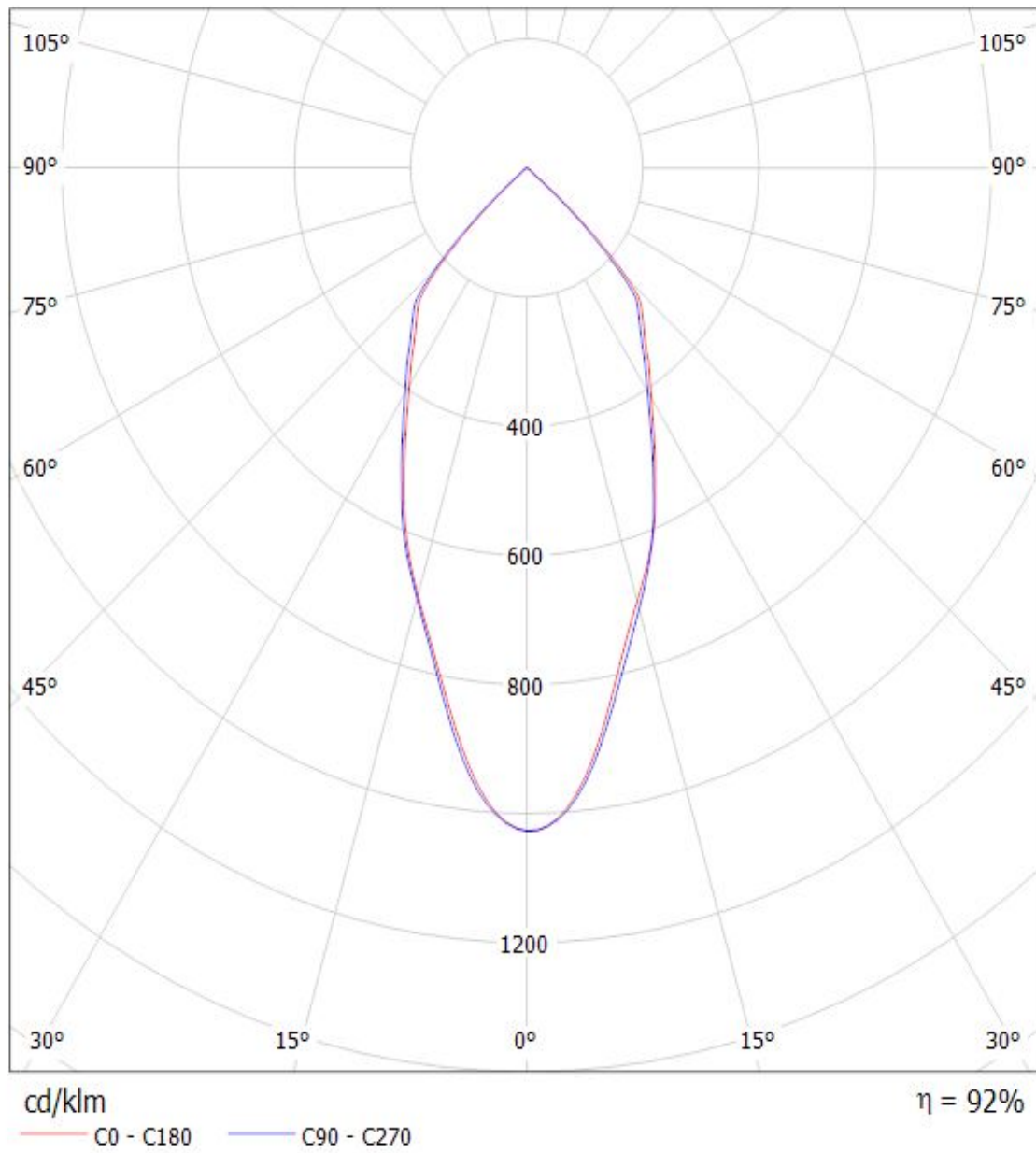

Luminaire: Ledil Oy F13402_ANGELINA-W_Bridgelux_V22_Gen7_SIMULATED F13402_ANGELINA-W_Bridgelux_V22_Gen7_SIMULATED
Lamps: 1 x F13402_ANGELINA-W_Bridgelux_V22_Gen7_SIMULATED

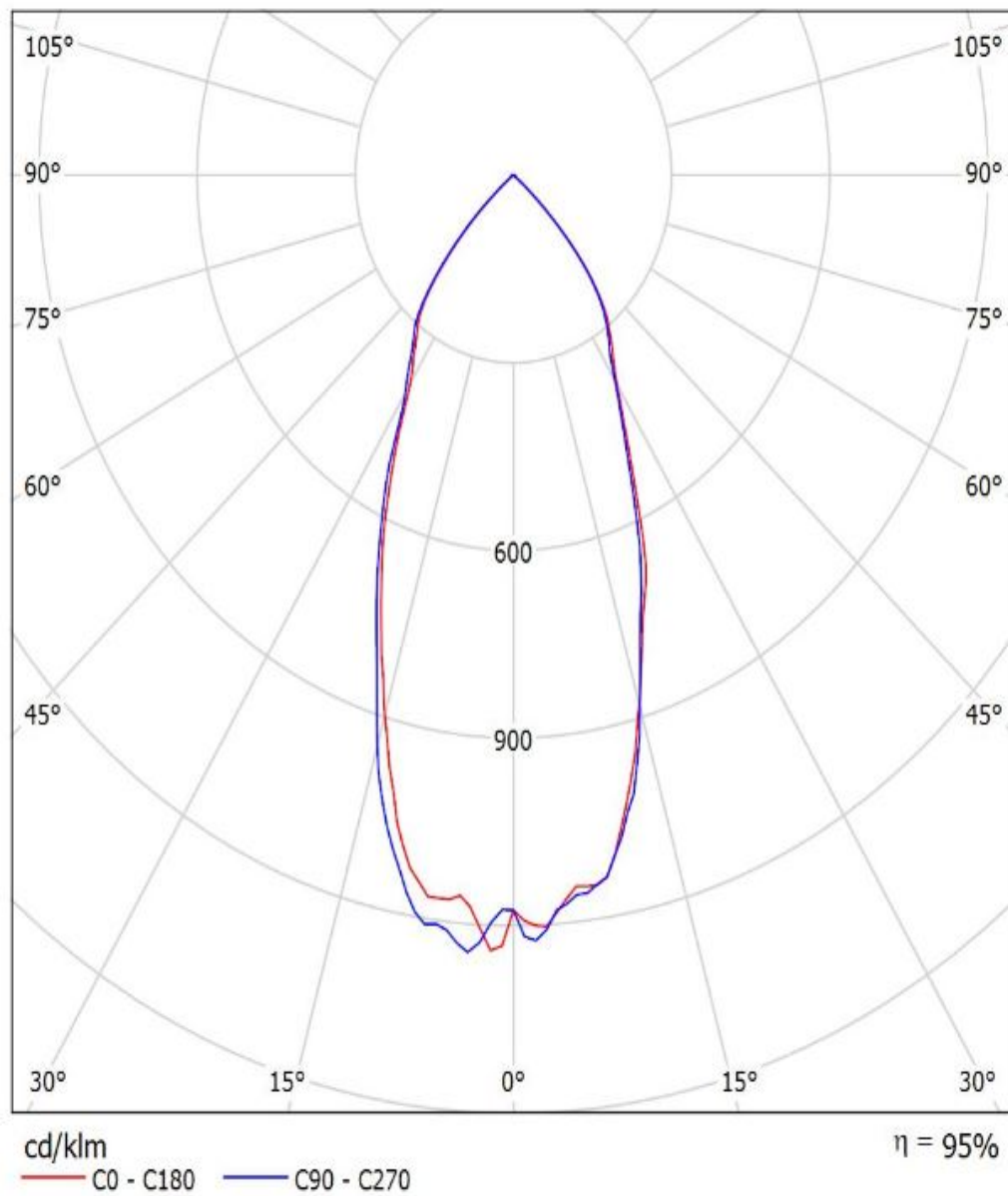

Luminaire: LEDiL Oy F13402_ANGELINA-W_(CLL030) Eff.92.6%

Lamps: 1 x CITIZEN_CLL030_(CLL030-1205A5-303H1A7)_758.588lm@250mA_CCT=5090K_P=8.61086W_I=249.8mA

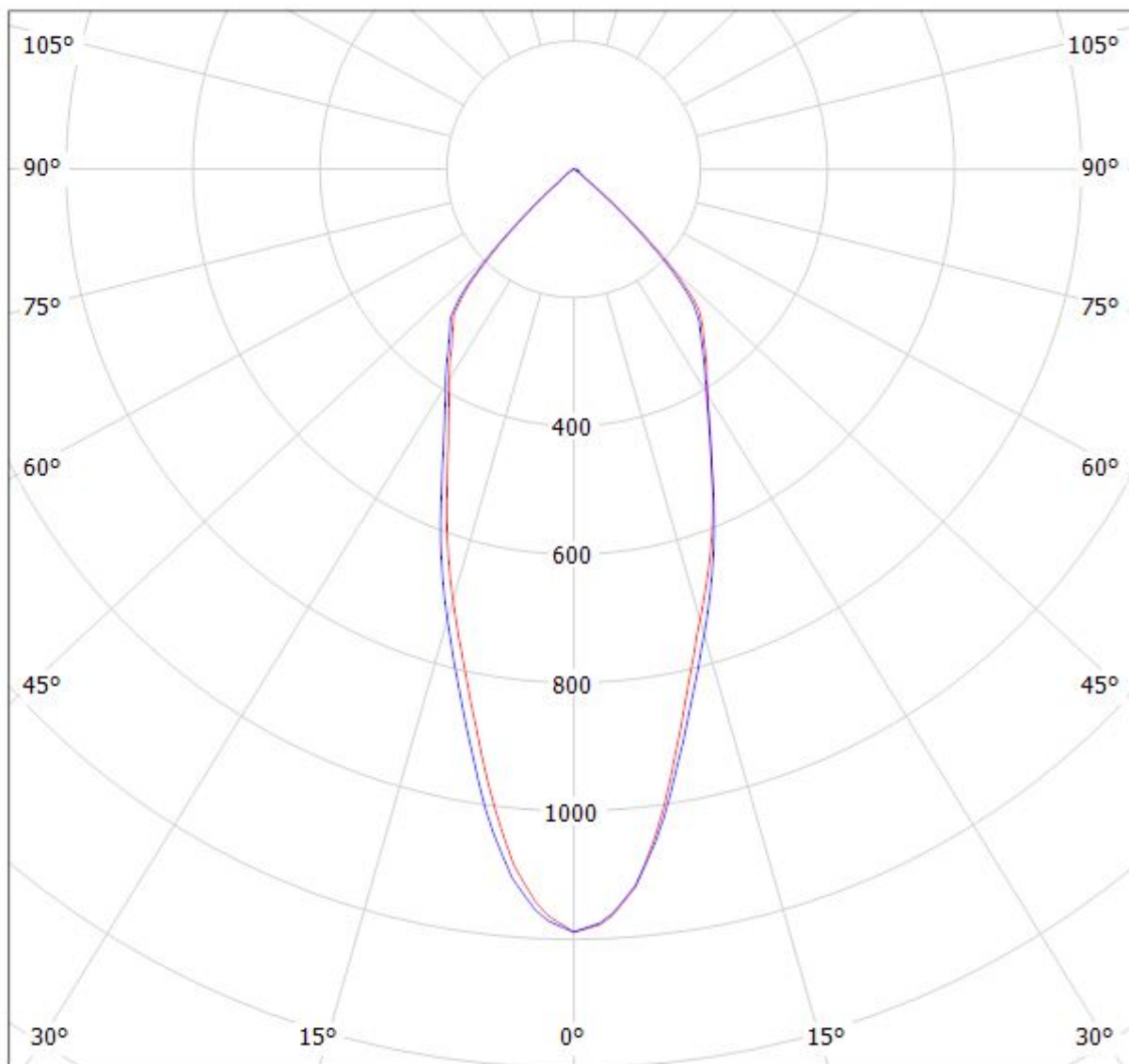

cd/klm

— C0 - C180

— C90 - C270

$\eta = 93\%$

Luminaire: LEDiL F13402_ANGELINA-W

Lamps: 1 x CLL030 740lm@250mA (CLL030-1205A5-303H1A7) CCT:3000K P:8.6W

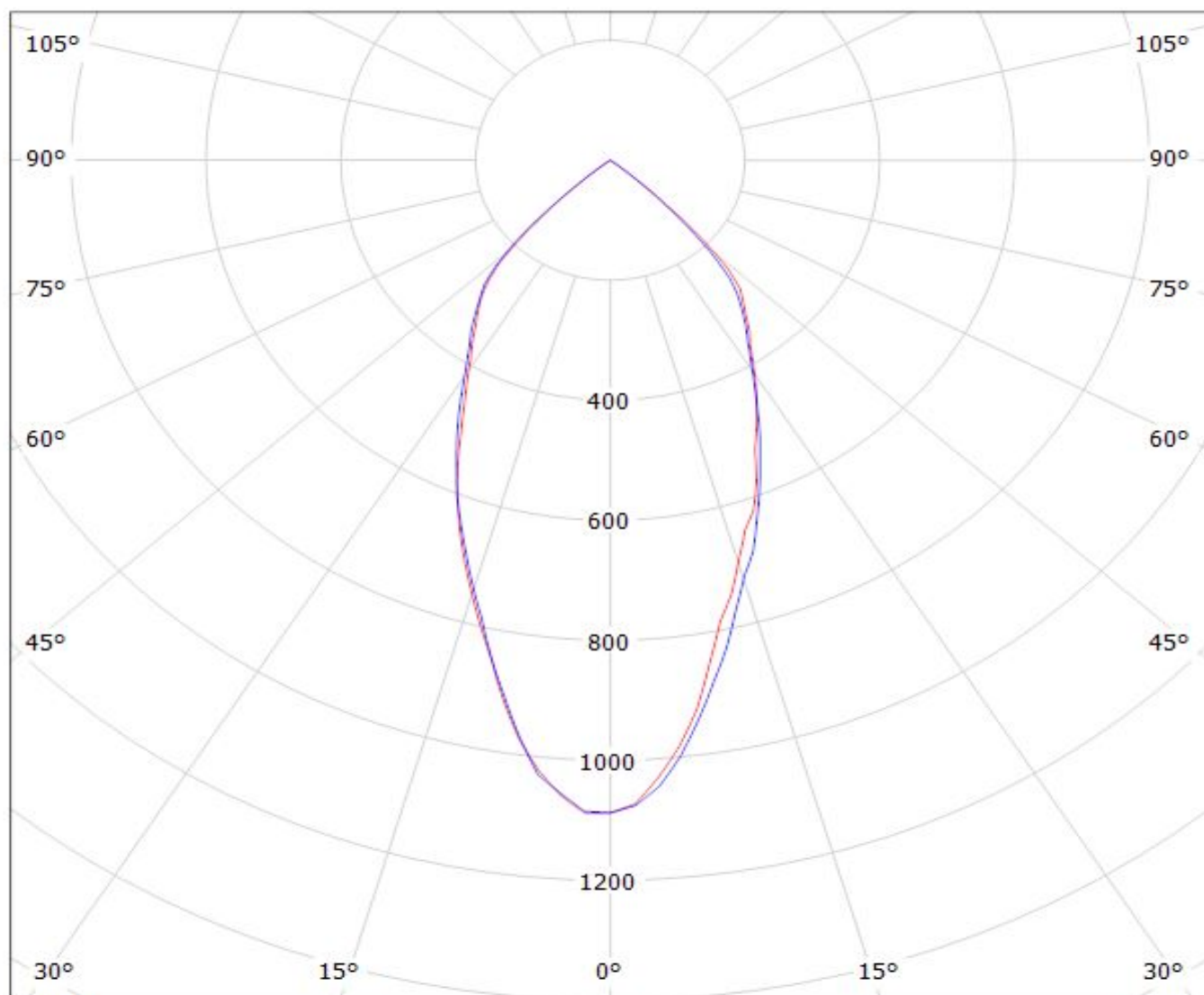

cd/klm

— C0 - C180

— C90 - C270

$\eta = 93\%$

Luminaire: Ledil F13402_ANGELINA-W_(CLU720)
Lamps: 1 x CITIZEN_CLU720_(CLU720-1206B8-273M2)
_1337.27lm@250mA_CCT=2700K_P=8.35W_I=0.25A

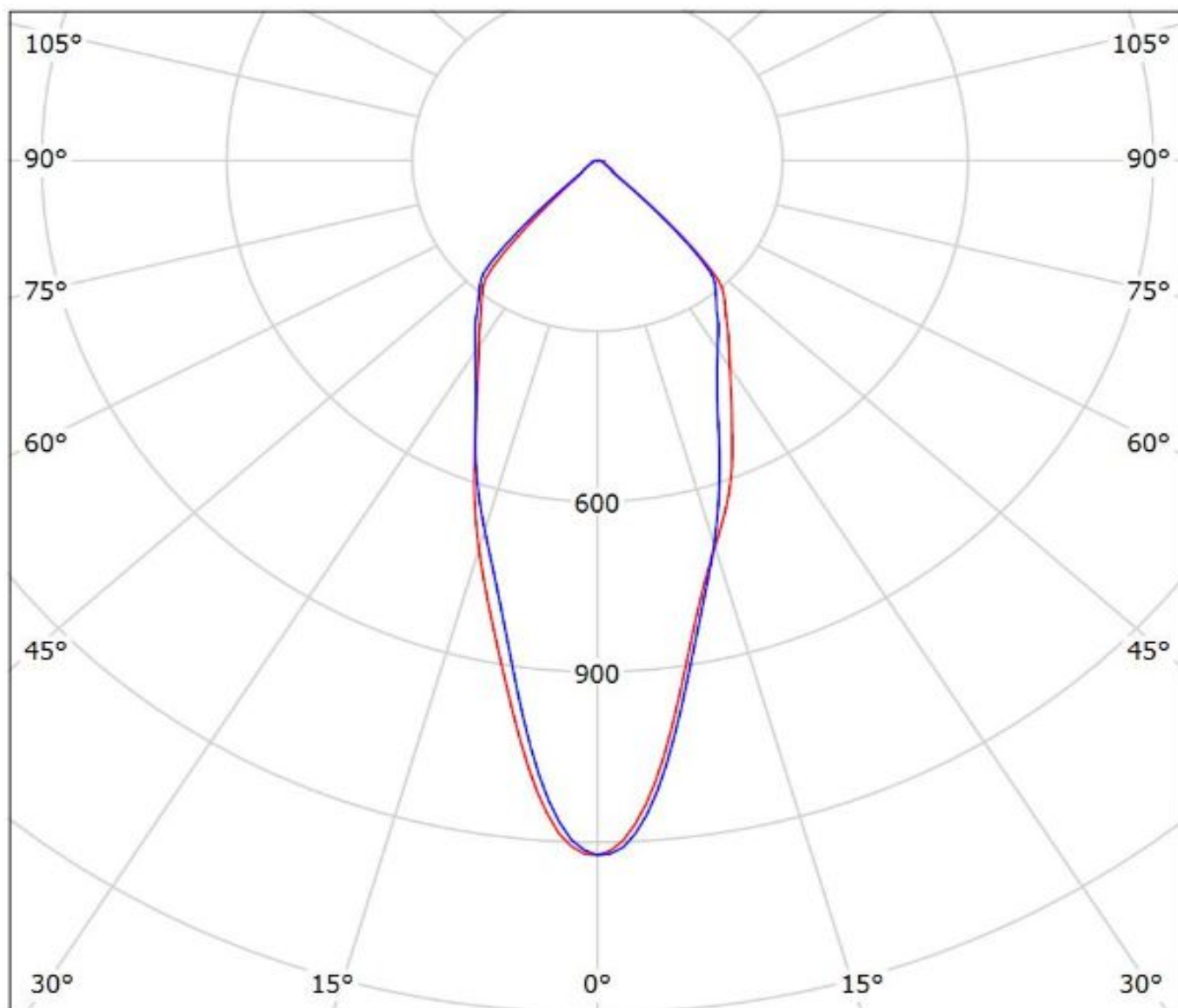

cd/klm

— C0 - C180 — C90 - C270

$\eta = 93\%$

Ledil F13402_ANGELINA-W_(CLU720) / LDC (Polar)

Luminaire: Ledil F13402_ANGELINA-W_(CLU720)
Lamps: 1 x CITIZEN_CLU720_(CLU720-1206B8-273M2)
_1340.38lm@250mA_CCT=2700K_P=8.35W_I=0.25A

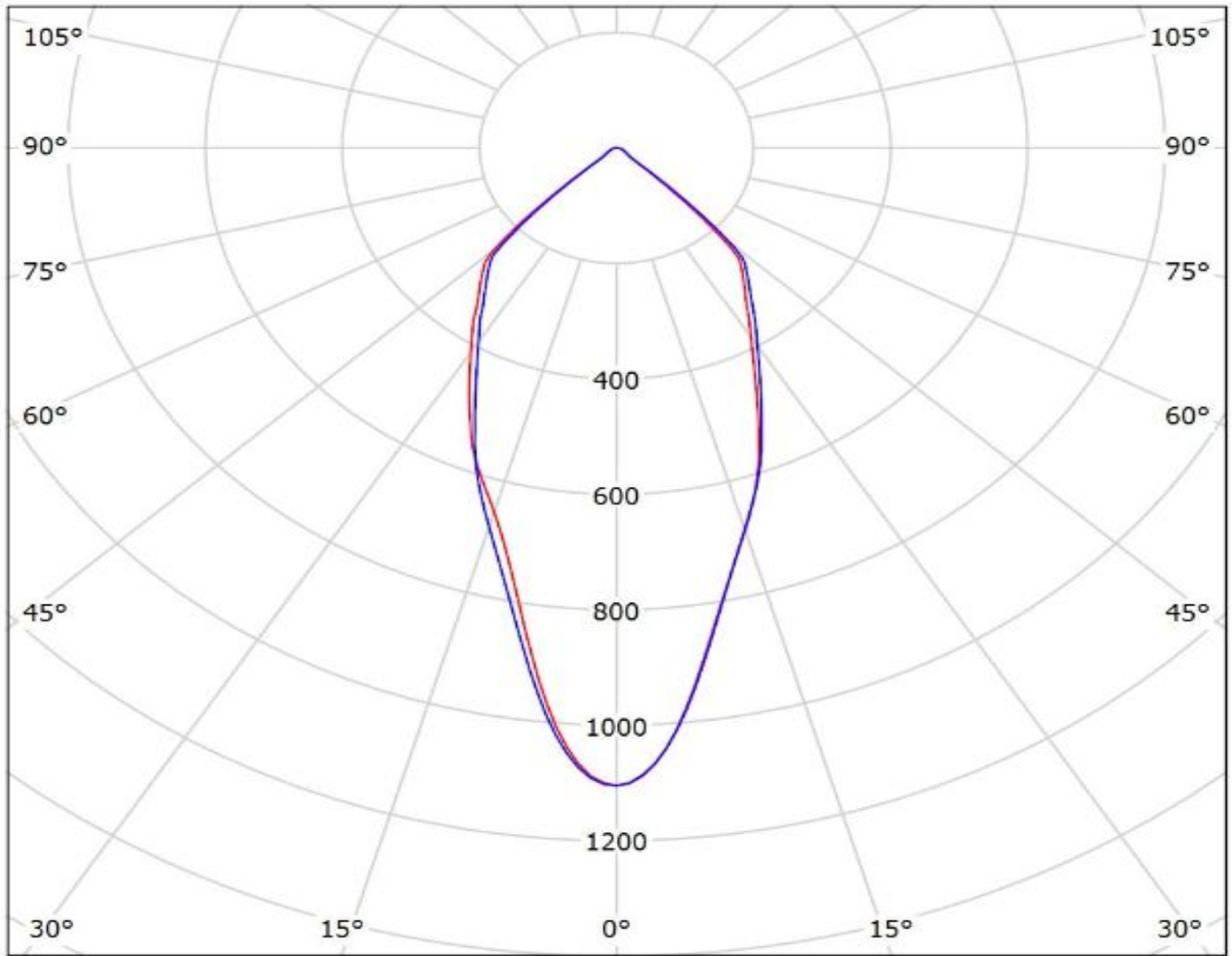

cd/klm
— C0 - C180 — C90 - C270

$\eta = 94\%$

Luminaire: Ledil F13402_ANGELINA-W_(CLU046+IDEAL)

Lamps: 1 x Citizen_CLU046_(-1212C1-303M2G2)_1383.92lm@250mA_CCT=3000K_P=8.122W_I=0.25A

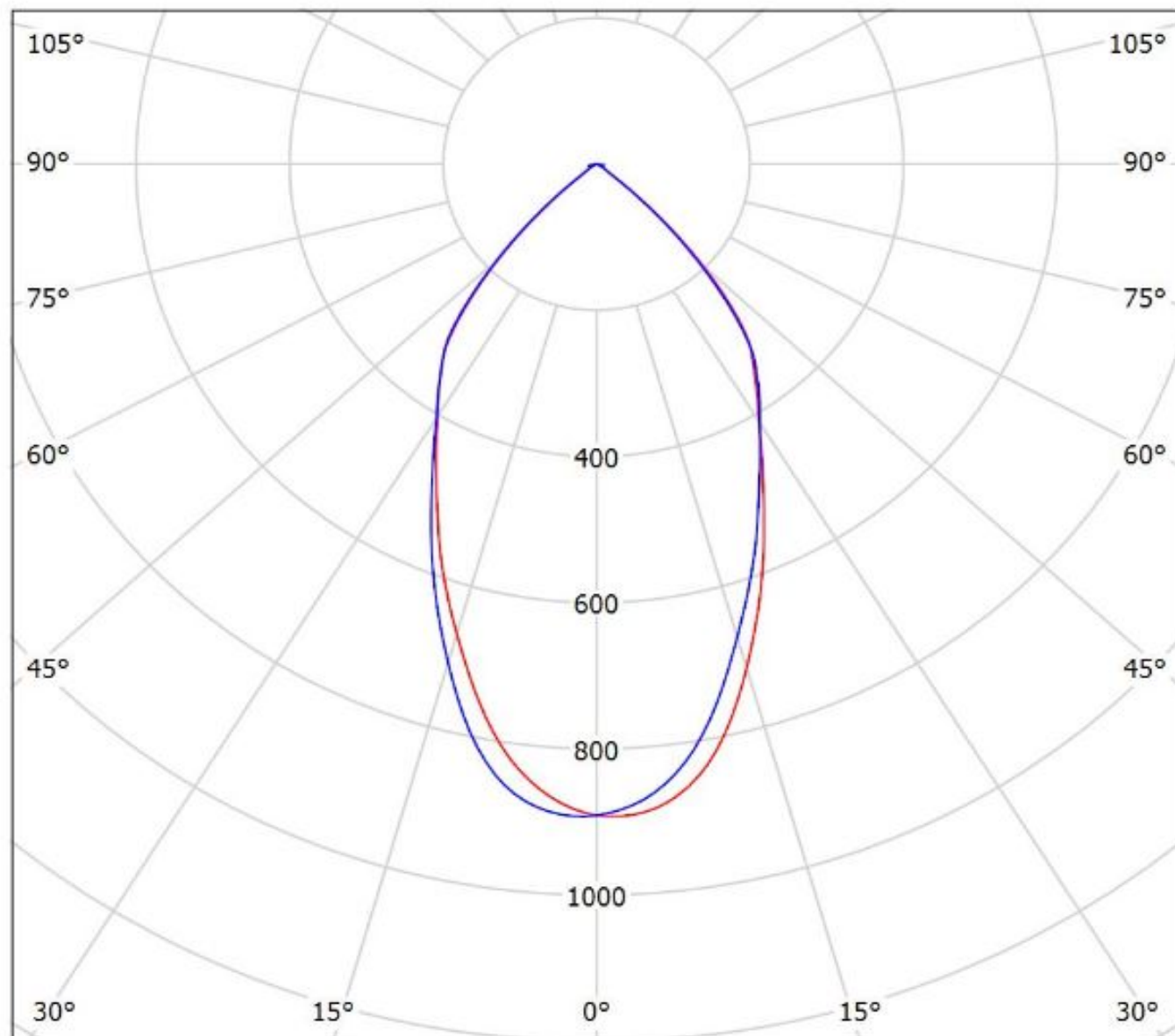

cd/klm

— C0 - C180 — C90 - C270

$\eta = 91\%$

Luminaire: Ledil F13402_ANGELINA-W_(CLU730+IDEAL)

Lamps: 1 x Citizen_CLU730_(-1210B8-273M2G1)_IDEAL_50-2204C+50-2100AN

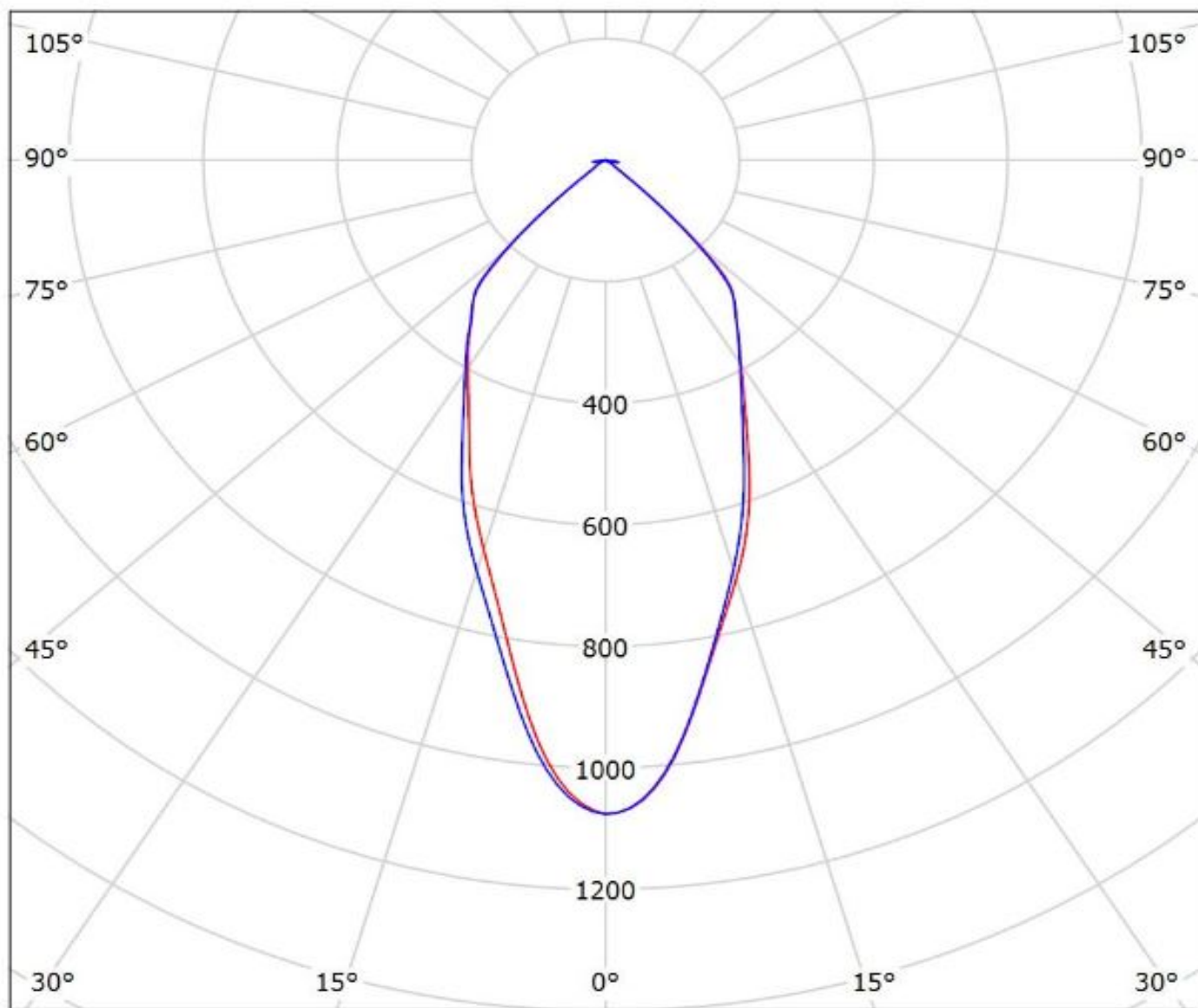

cd/klm

— C0 - C180

— C90 - C270

$\eta = 91\%$

Luminaire: LEDiL Oy F13402_ANGELINA-W_(CXA25) Eff.93.9%

Lamps: 1 x CREE_CXA25_(CXA2530-7C0-T2-N0H)_1151.98lm@250mA_CCT=3000K_P=8.4892W_I=249.8mA

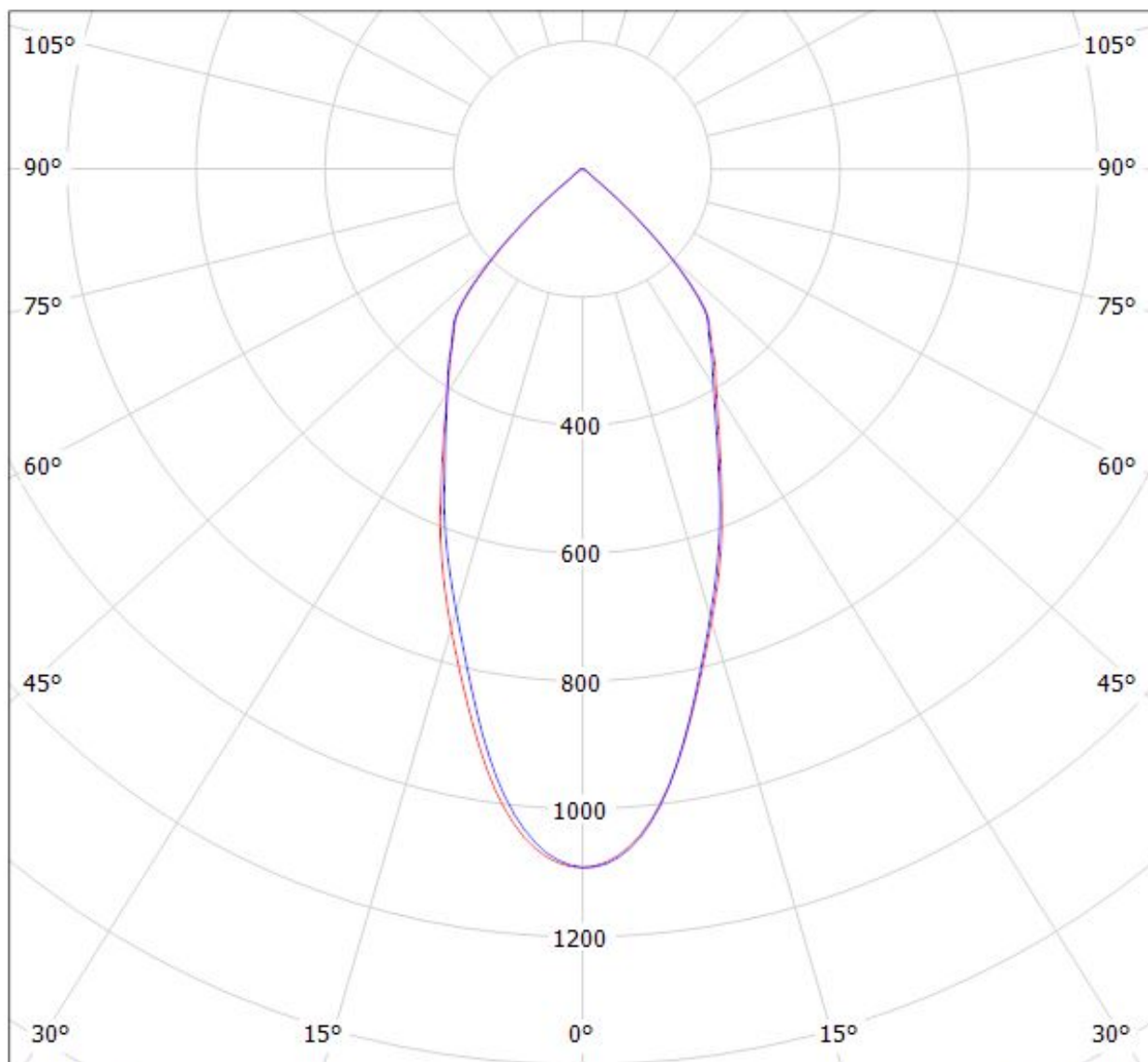

cd/klm

— C0 - C180

— C90 - C270

$\eta = 94\%$

Luminaire: LEDiL Oy F13402_ANGELINA-W_(CXA30) Eff. 93%

Lamps: 1 x CREE_CXA30_(CXA3050-3C0-Y2-N0H)_1340.66lm@250mA_P=8.16471W_CCT=5000K_I=249.8mA

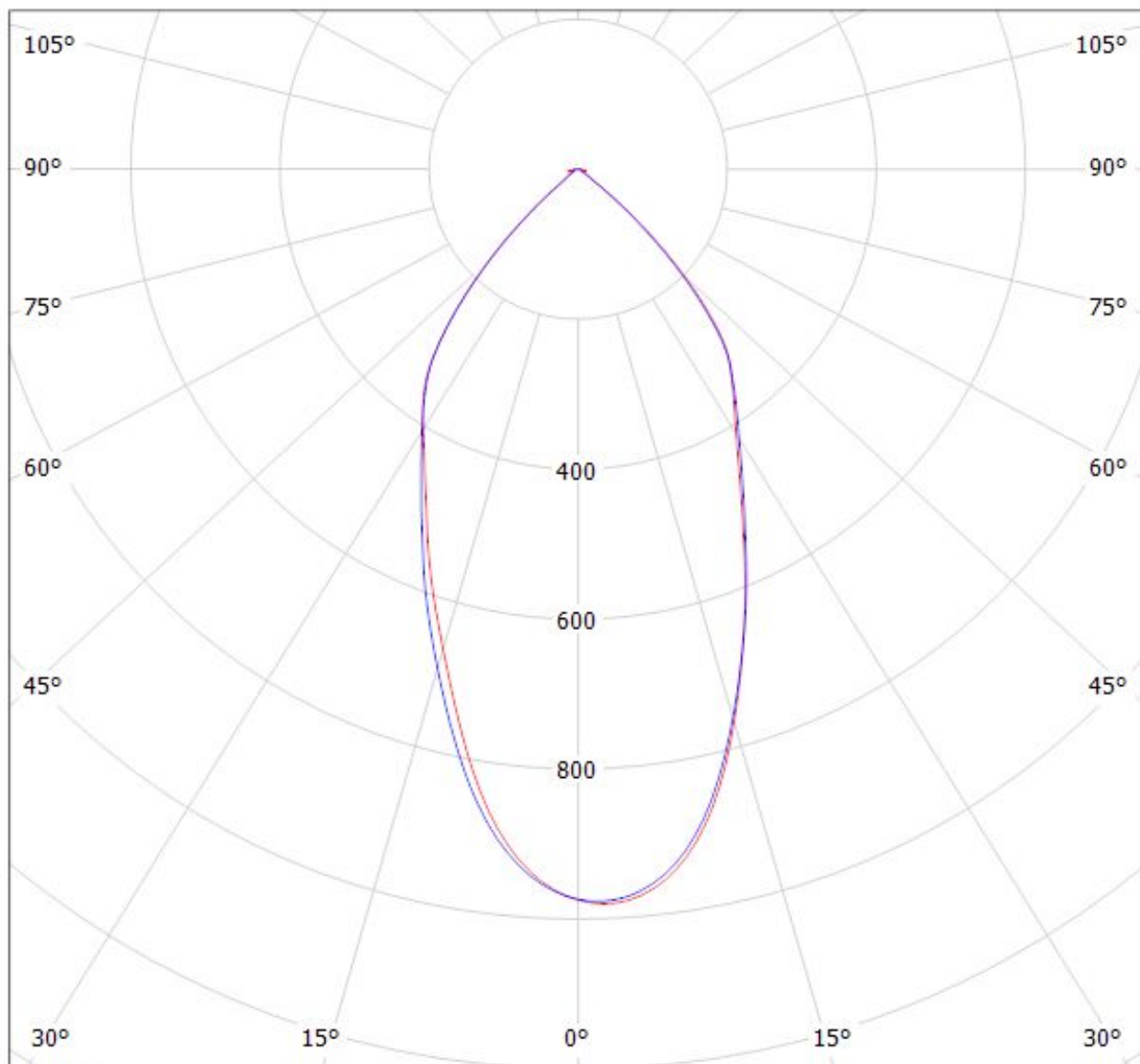

cd/klm

— C0 - C180

— C90 - C270

$\eta = 93\%$

Luminaire: LEDiL Oy F13402_ANGELINA-W_(CXA1816) Eff. 94%
Lamps: 1 x CREE_CXA1816_1042.78lm@250mA_P=8.65157W_I=249.9mA

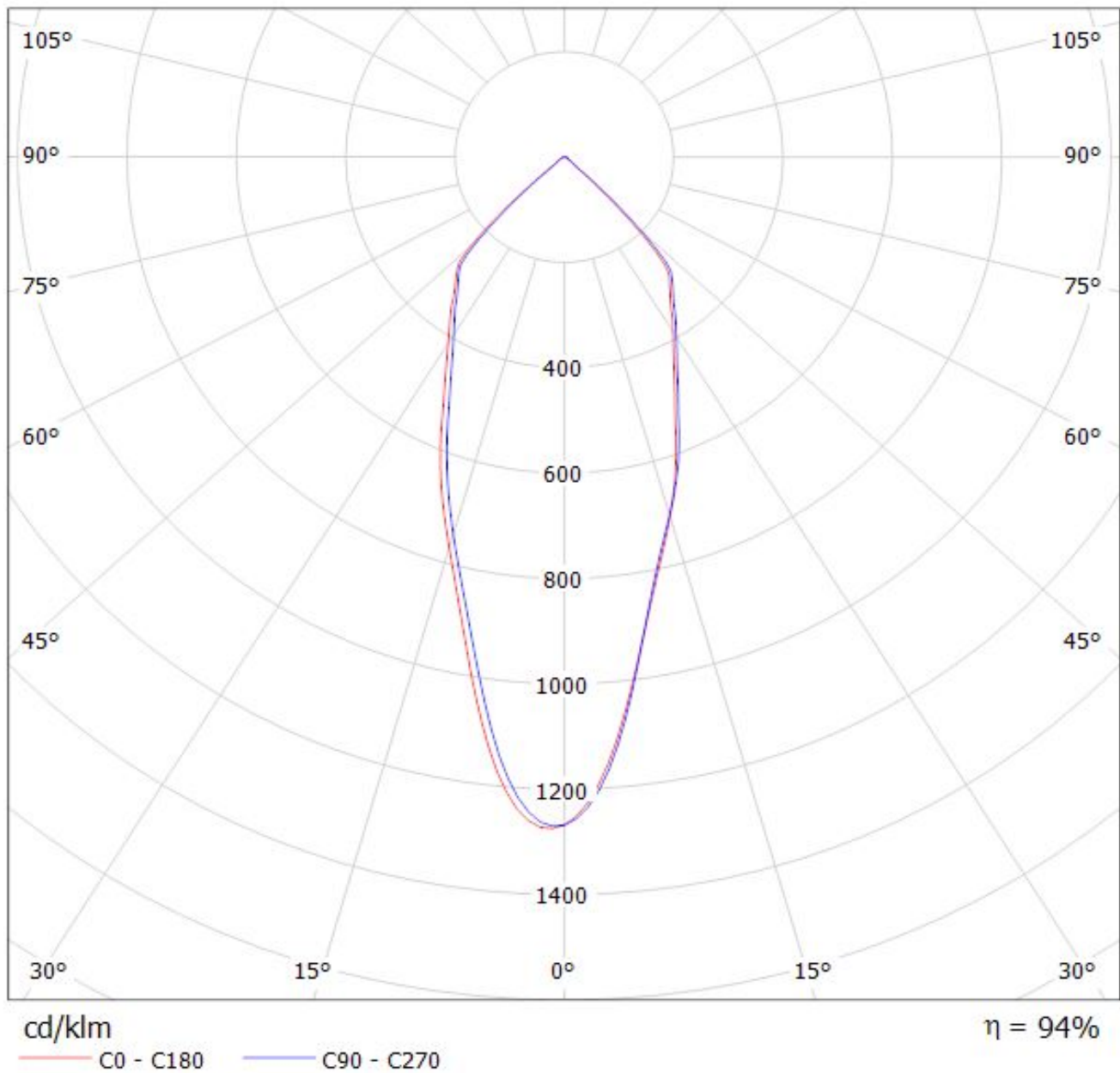

Luminaire: LEDiL Oy F13402_ANGELINA-W_(CXA3590)

Lamps: 1 x CREE_CXA3590_(CXA3590-30F-BD-R0H-0002)_2640.14lm@250mA_CCT=3000K_P=16.3941W_I=249.8mA

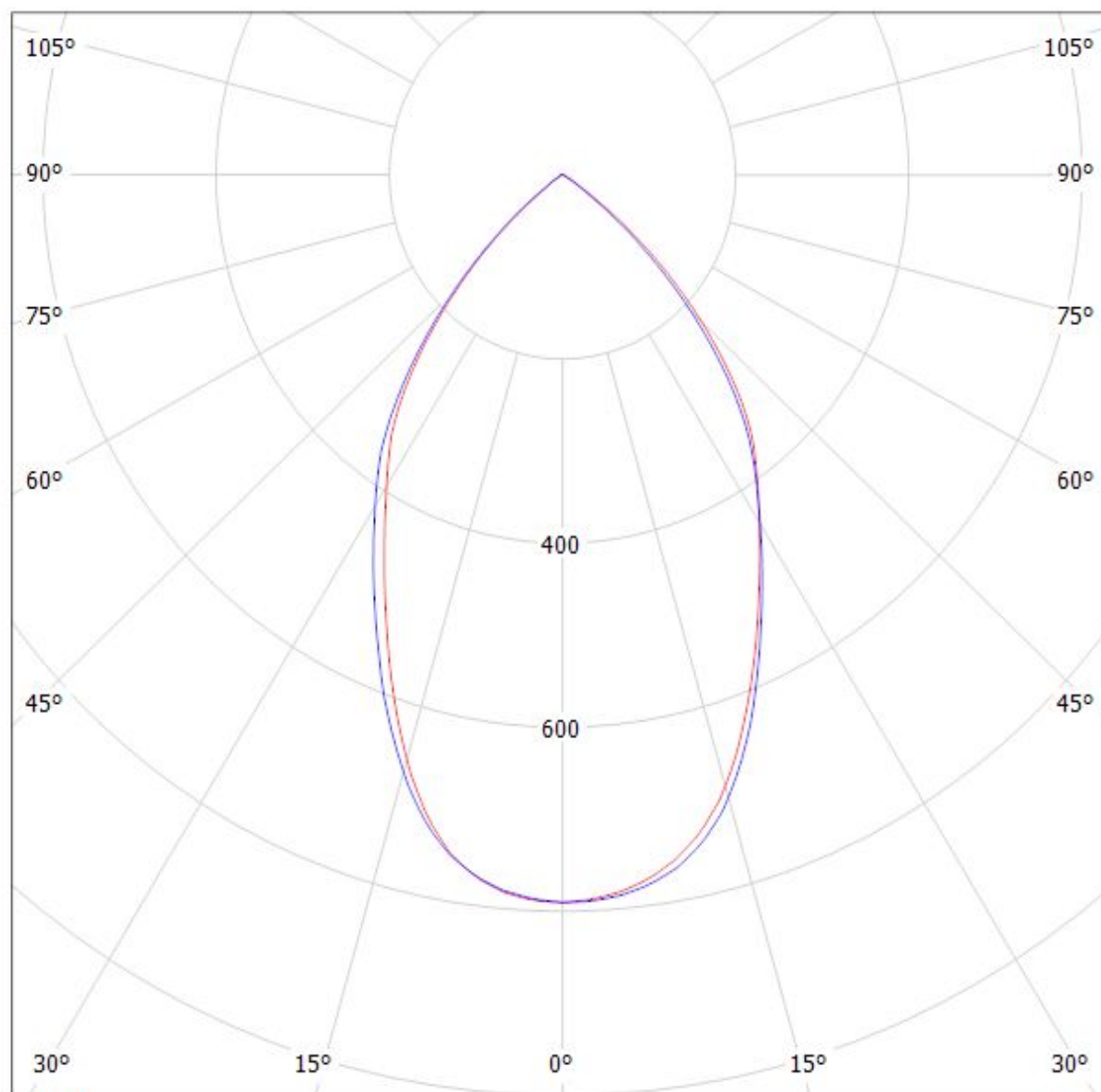

cd/klm

— C0 - C180

— C90 - C270

$\eta = 93\%$

Luminaire: LEDiL Oy F13402_ANGELINA-W_(LG_COB-10W) Eff.93.1%
Lamps: 1 x LG_COB-10W_1024lm@250mA_CCT=5090K_P=9W_I=250mA

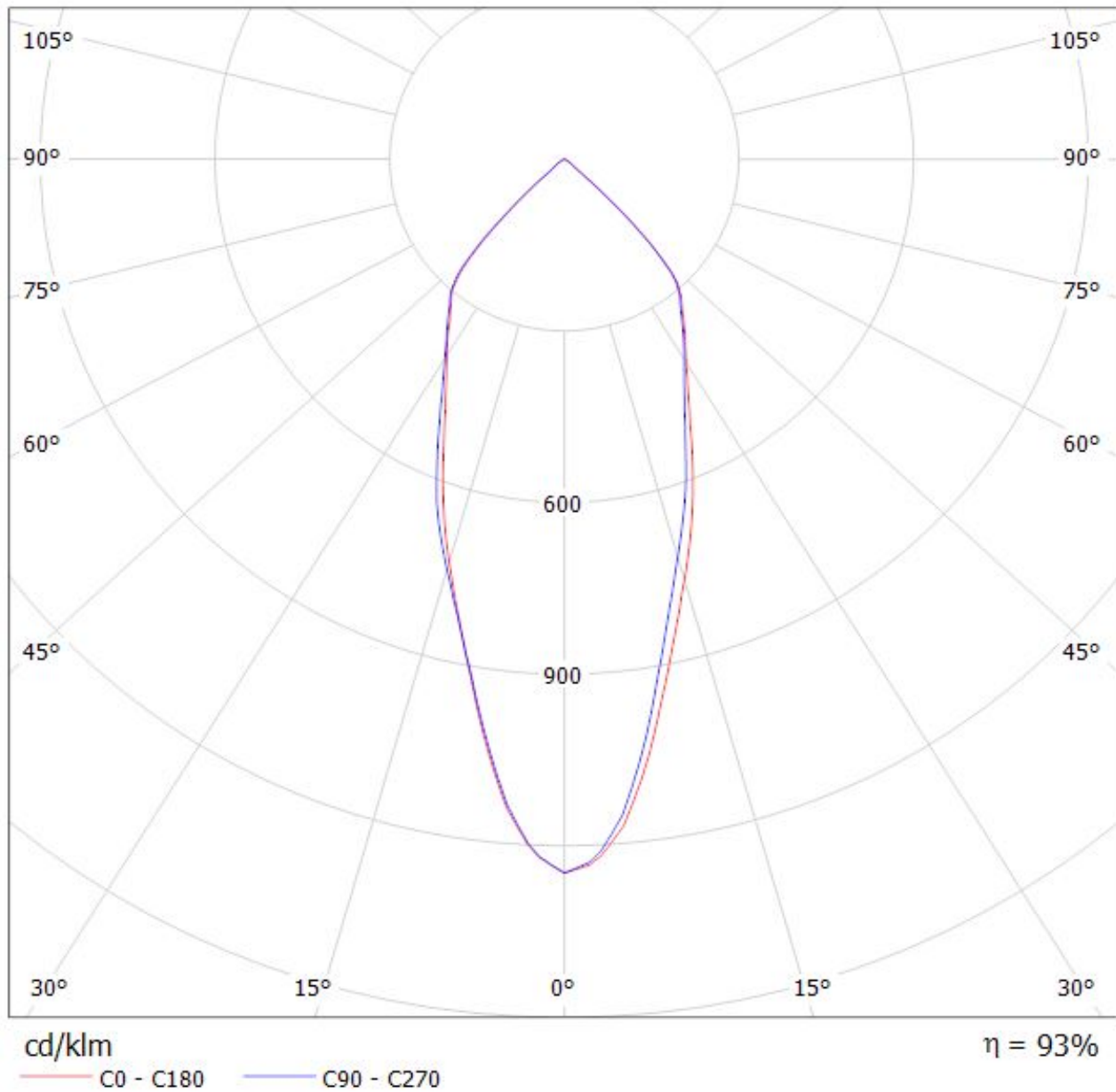

LEDiL Oy C13402_ANGELINA-W_(LUXEON_K16) Eff.93.7% / LDC (Polar)

Luminaire: LEDiL Oy C13402_ANGELINA-W_(LUXEON_K16) Eff.93.7%
Lamps: 1 x LUXEON_K16 (1204.33lm@250mA)

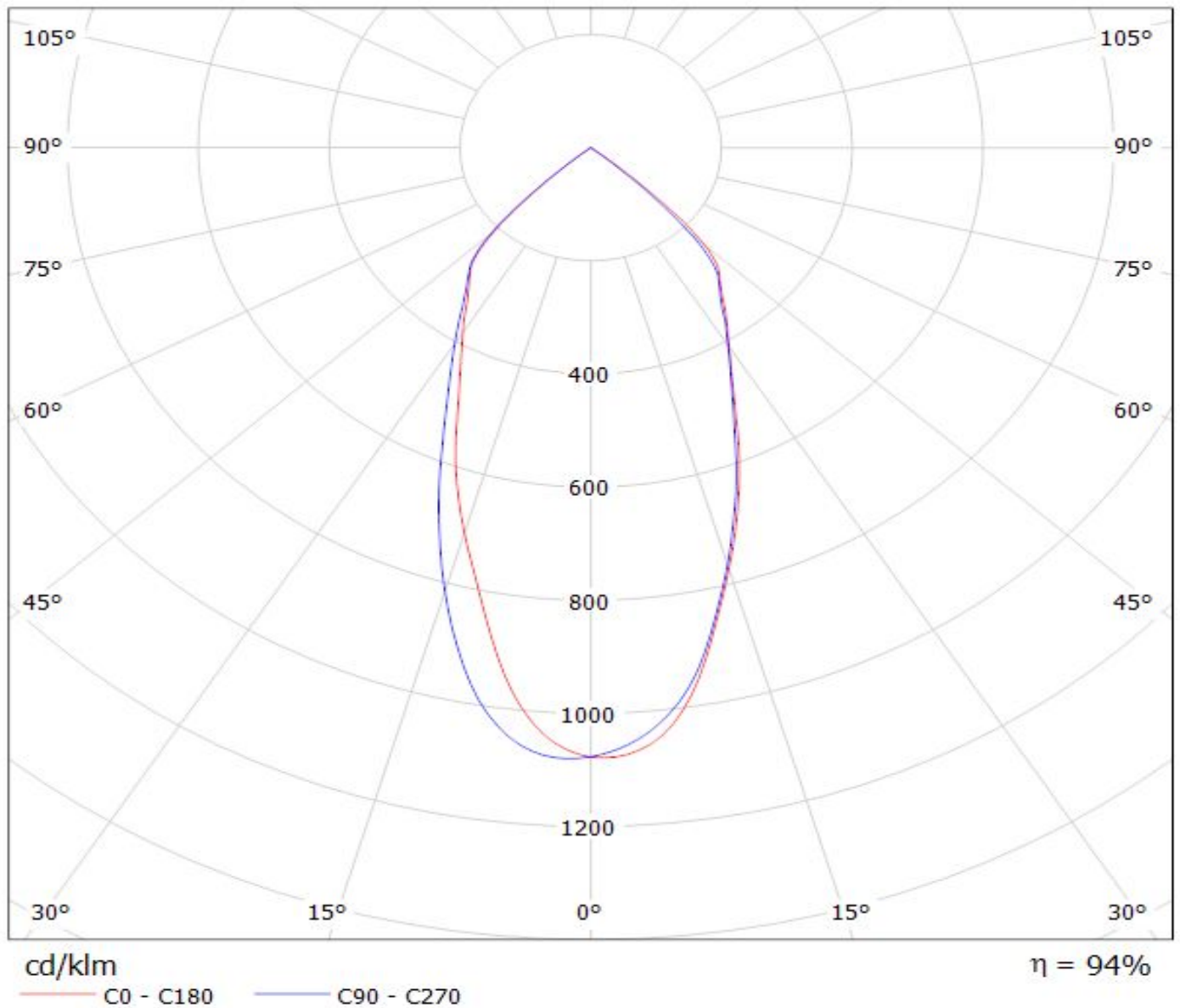

LEDiL Oy C13402_ANGELINA-W_(LUXEON_K12) Eff.94.0% / LDC (Polar)

Luminaire: LEDiL Oy C13402_ANGELINA-W_(LUXEON_K12) Eff.94.0%

Lamps: 1 x LUXEON_K12 (929.543lm@250mA)

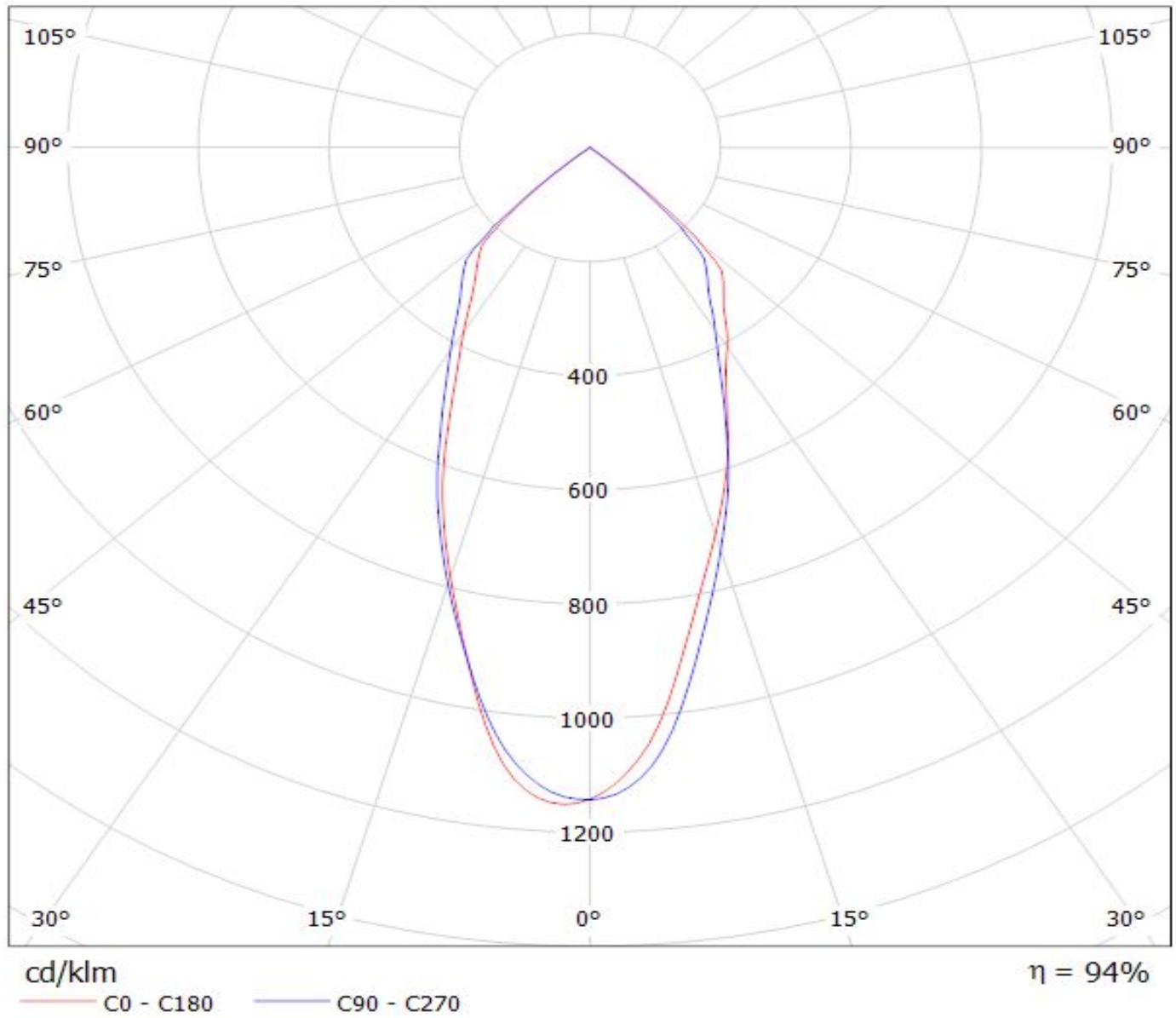

Luminaire: LEDiL Oy F13402_ANGELINA-W_(LUXEON_CoB_1205) Eff: 94 %

Lamps: 1 x LUXEON CoB 1205 (LHC1-3080-1205) 1082lm@250mA CCT=3000K P=8.3W I=250mA

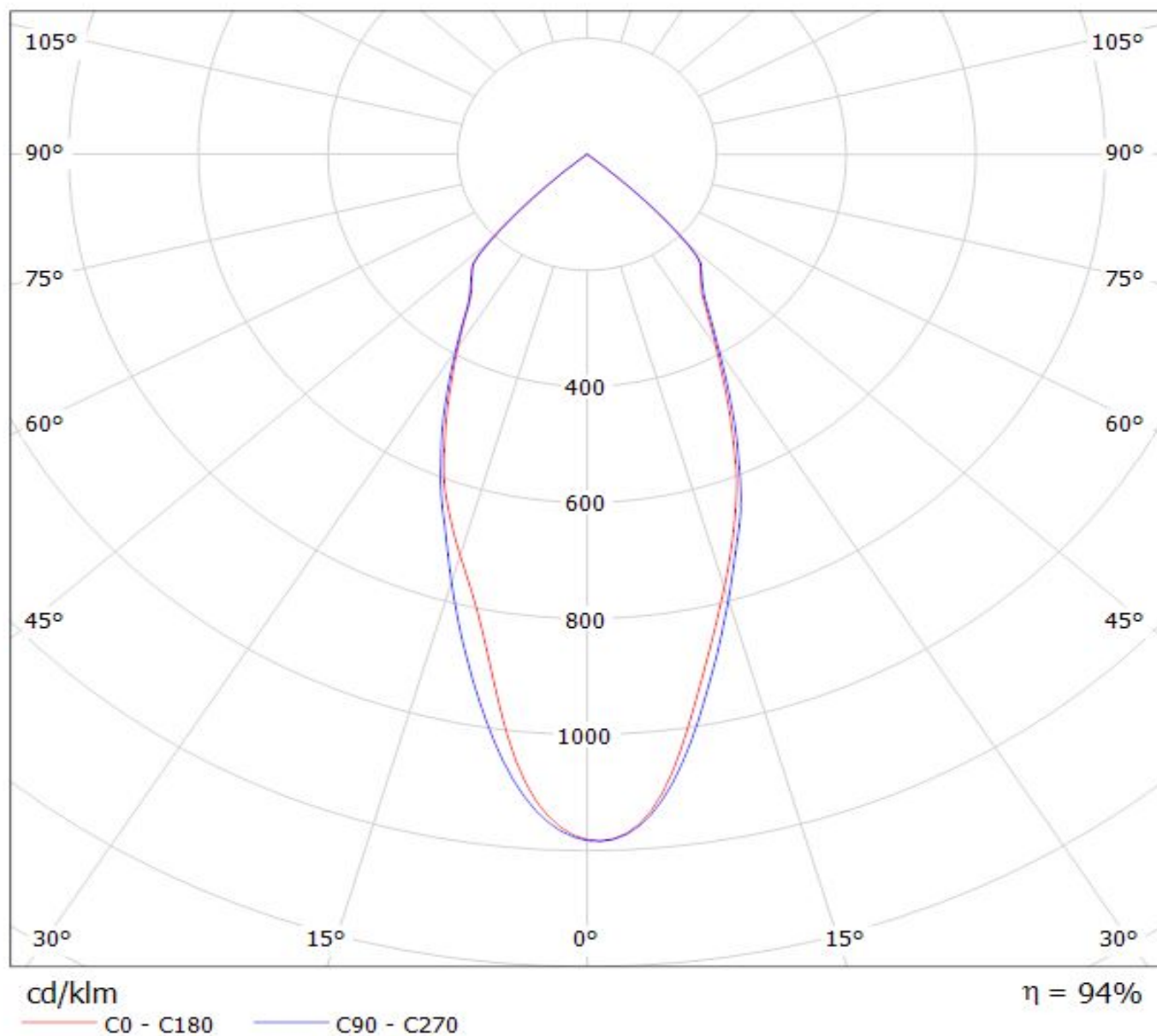

Luminaire: LEDiL Oy F13402_ANGELINA-W_(Luxeon-CoB-1208) Eff: 93 %
Lamps: 1 x Luxeon CoB 1208 (LHC1-3080-1208) 1029lm@250mA CCT=3000K P=8.2W I=250mA

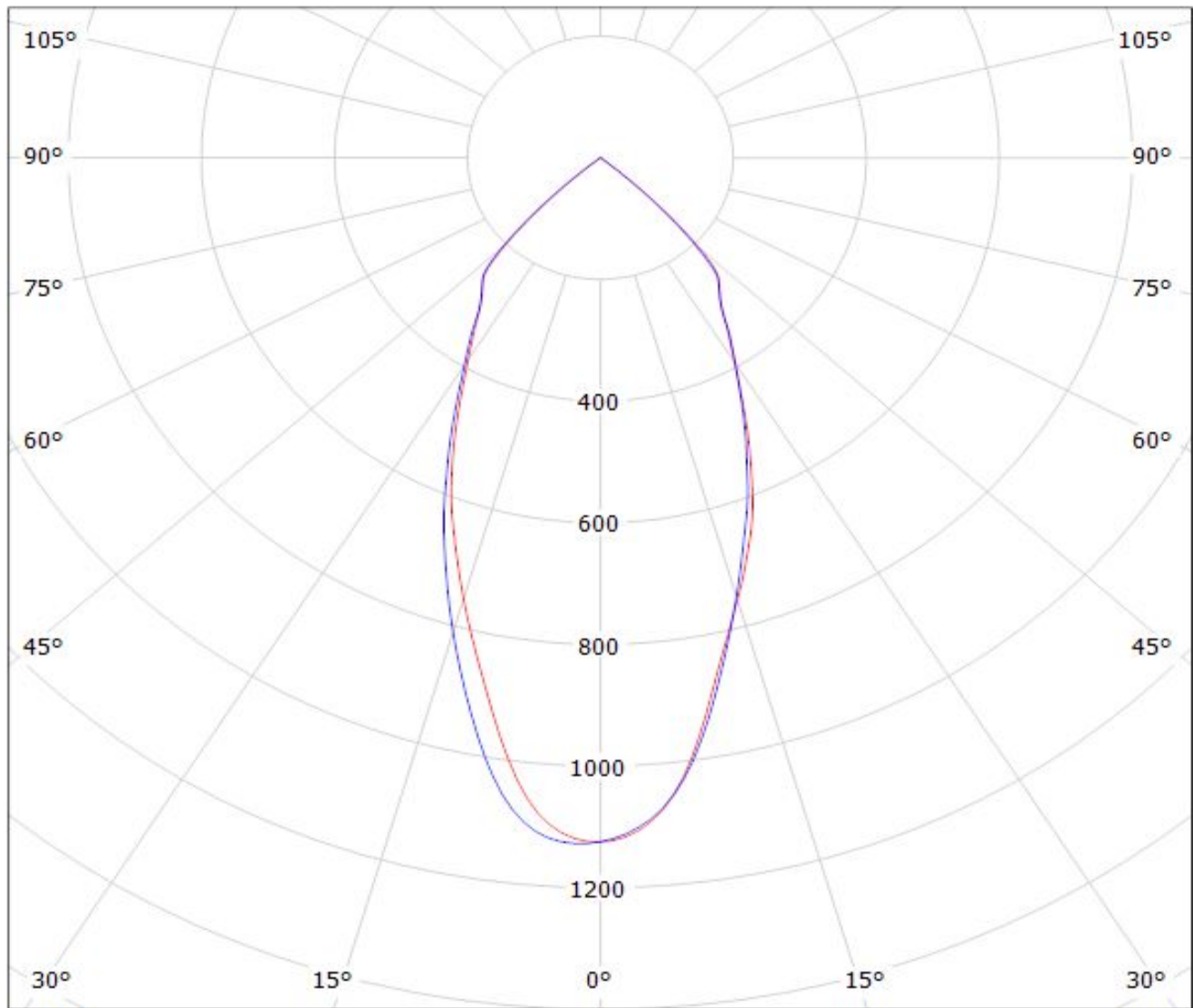

cd/klm

— C0 - C180

— C90 - C270

$\eta = 93\%$

Luminaire: LEDiL Oy F13402_ANGELINA-W_(LUXEON_COB_1205) Eff.93.0%
Lamps: 1 x LUXEON_COB_1205_(LHC1-3080-1205)_1084.49lm@250mA_CCT=3000K_P=8.31784W_I=249.8mA

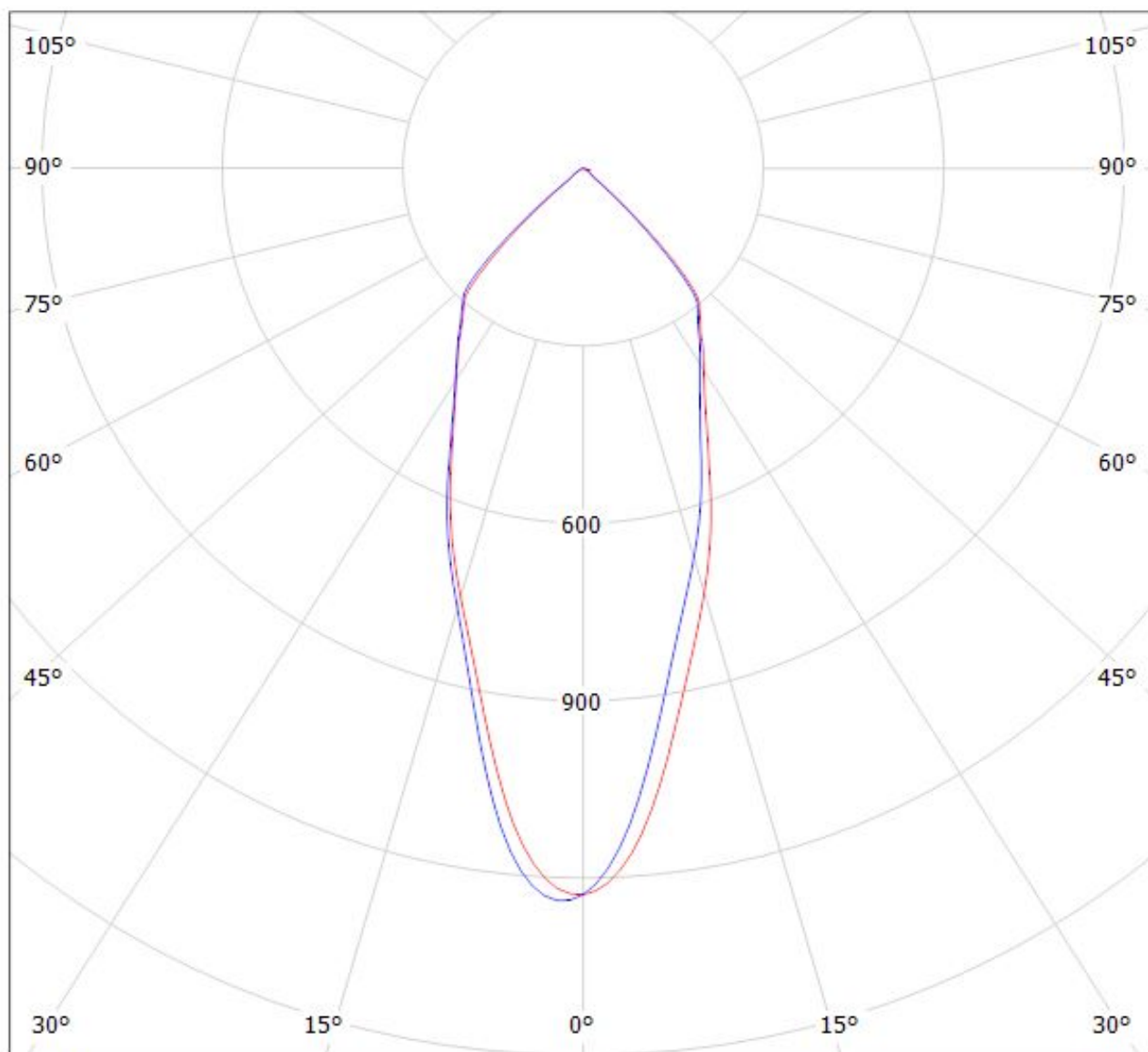

cd/klm

$\eta = 93\%$

— C0 - C180 — C90 - C270

Luminaire: LEDiL Oy F13402_ANGELINA-W_(LUXEON_COB_1208) Eff.93.3%

Lamps: 1 x LUXEON_COB_1208_(LHC1-3080-1208)_1015.13lm@250mA_CCT=3000K_P=8.15972W_I=249.8mA

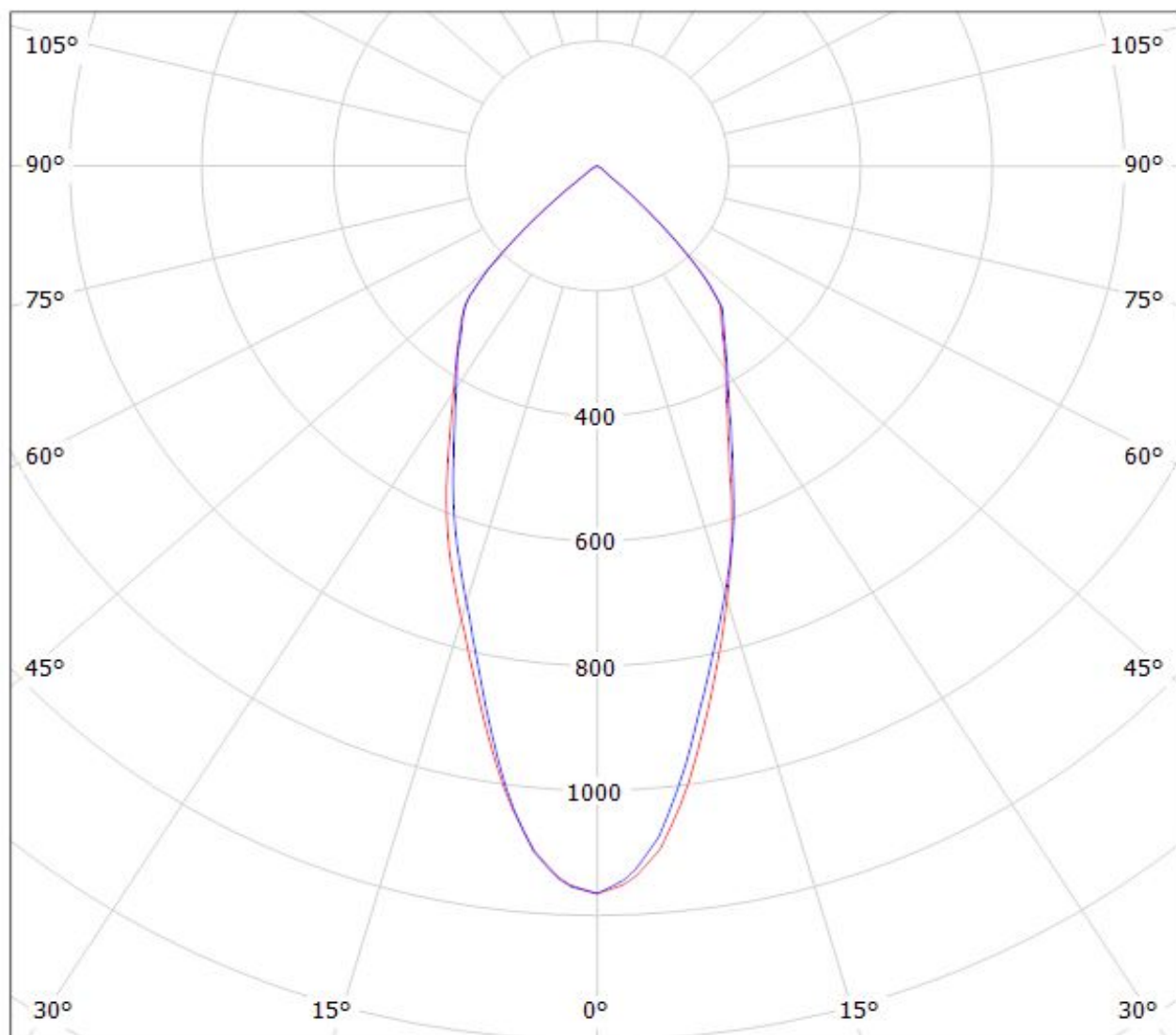

cd/klm

$\eta = 93\%$

— C0 - C180

— C90 - C270

Luminaire: Ledil F13402_ANGELINA-W_(CoB1211+IDEAL)
Lamps: 1 x Luxeon_CoB1211_(L2C2-4080)_50-2204CT+50-2100AN_1376.18lm@250mA_P=7.9988W_I=0.25A

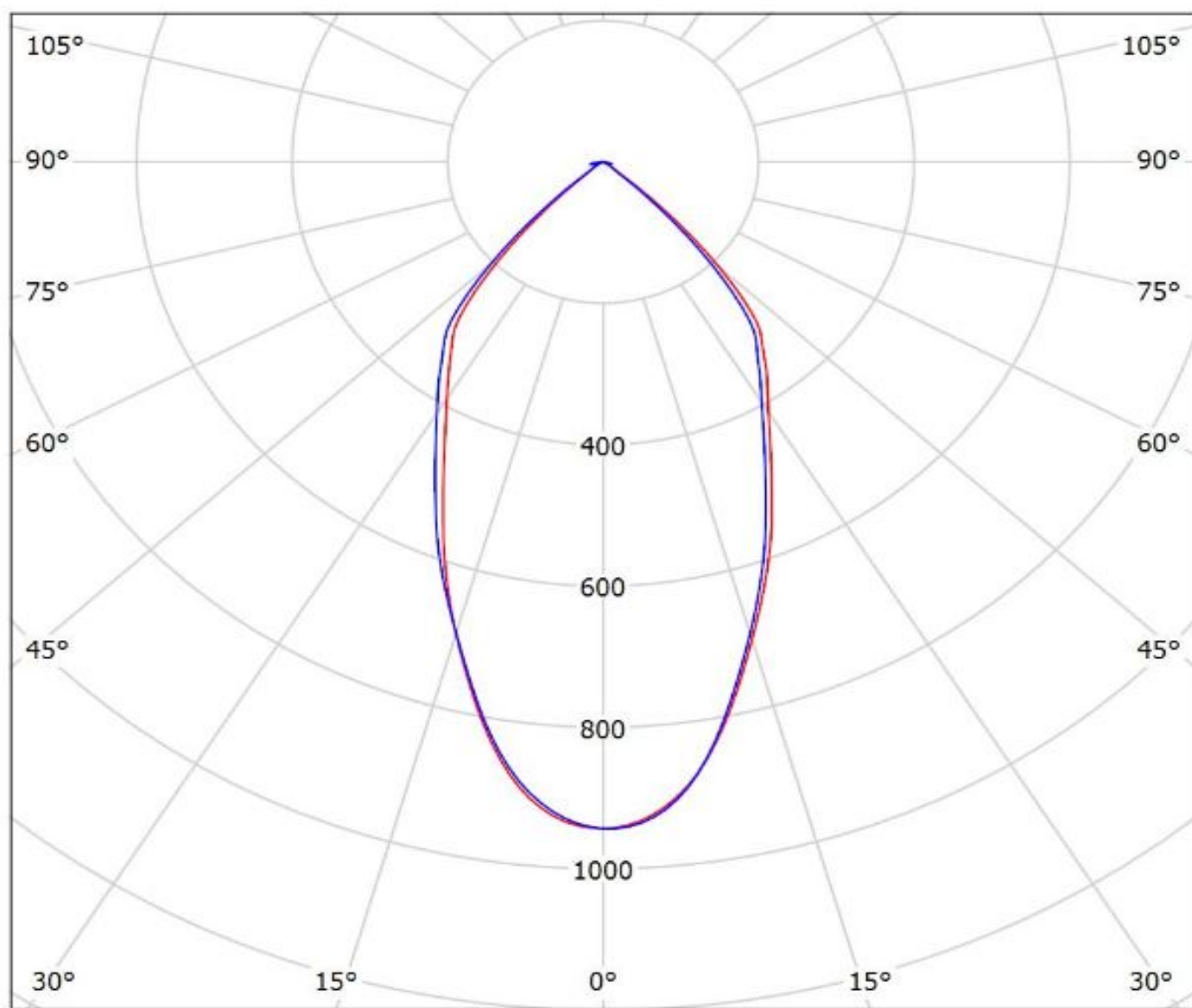

cd/klm

— C0 - C180 — C90 - C270

$\eta = 91\%$

Luminaire: LEDiL Oy F13402_ANGELINA-W_(CXM-14)

Lamps: 1 x LUMINUS_CXM-14_1114.36lm@250mA_P=8.36106W_I=249.8mA

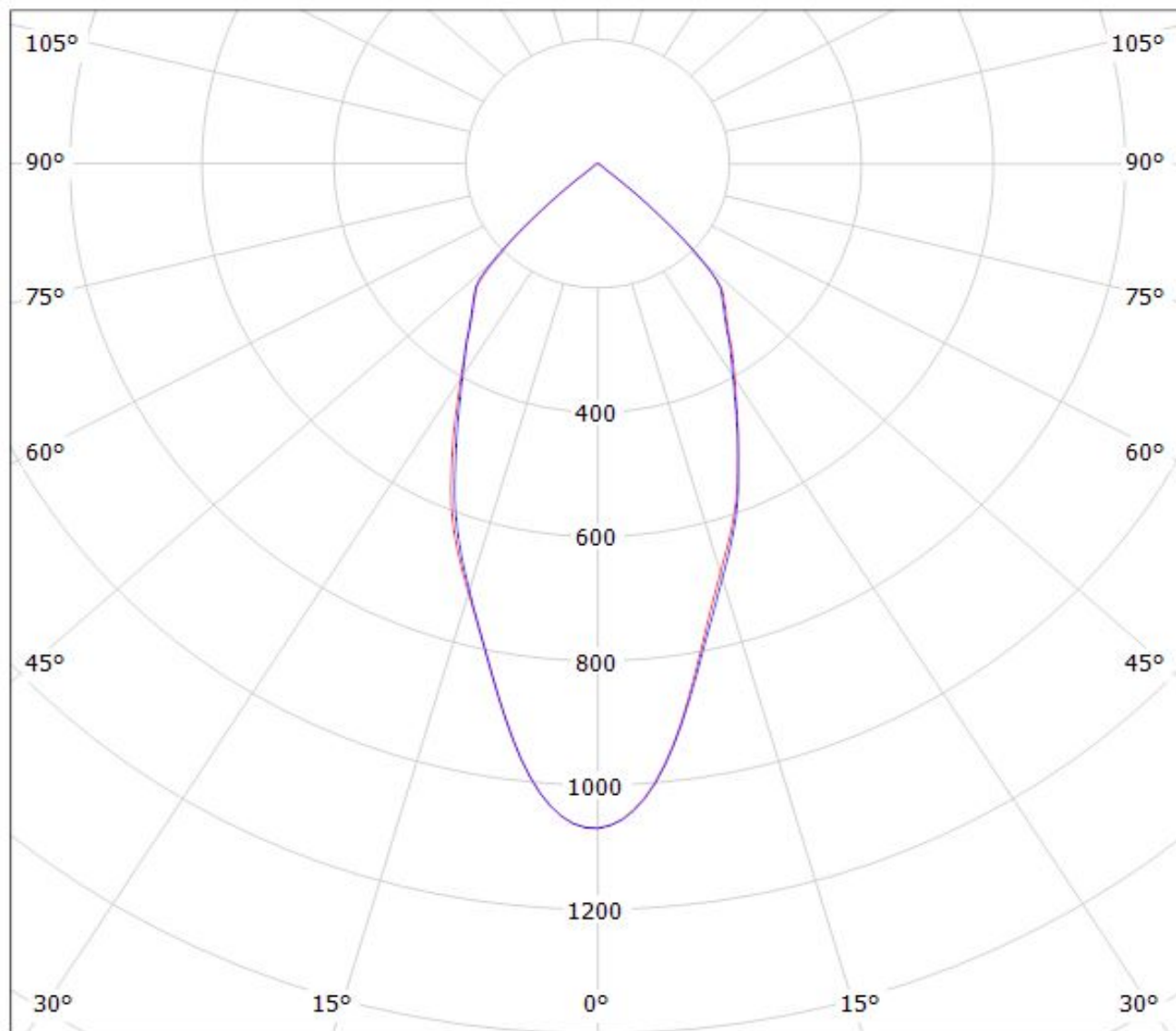

cd/klm

$\eta = 93\%$

— C0 - C180 — C90 - C270

Luminaire: LEDiL Oy F13402_ANGELINA-W_(NSCxJ216A) Eff.93.9%
Lamps: 1 x NICHIA_NSCxJ216A_(NSCLJ216AE)_949.847lm@250mA_CCT=3000K_P=7.96937W_I=249.8mA

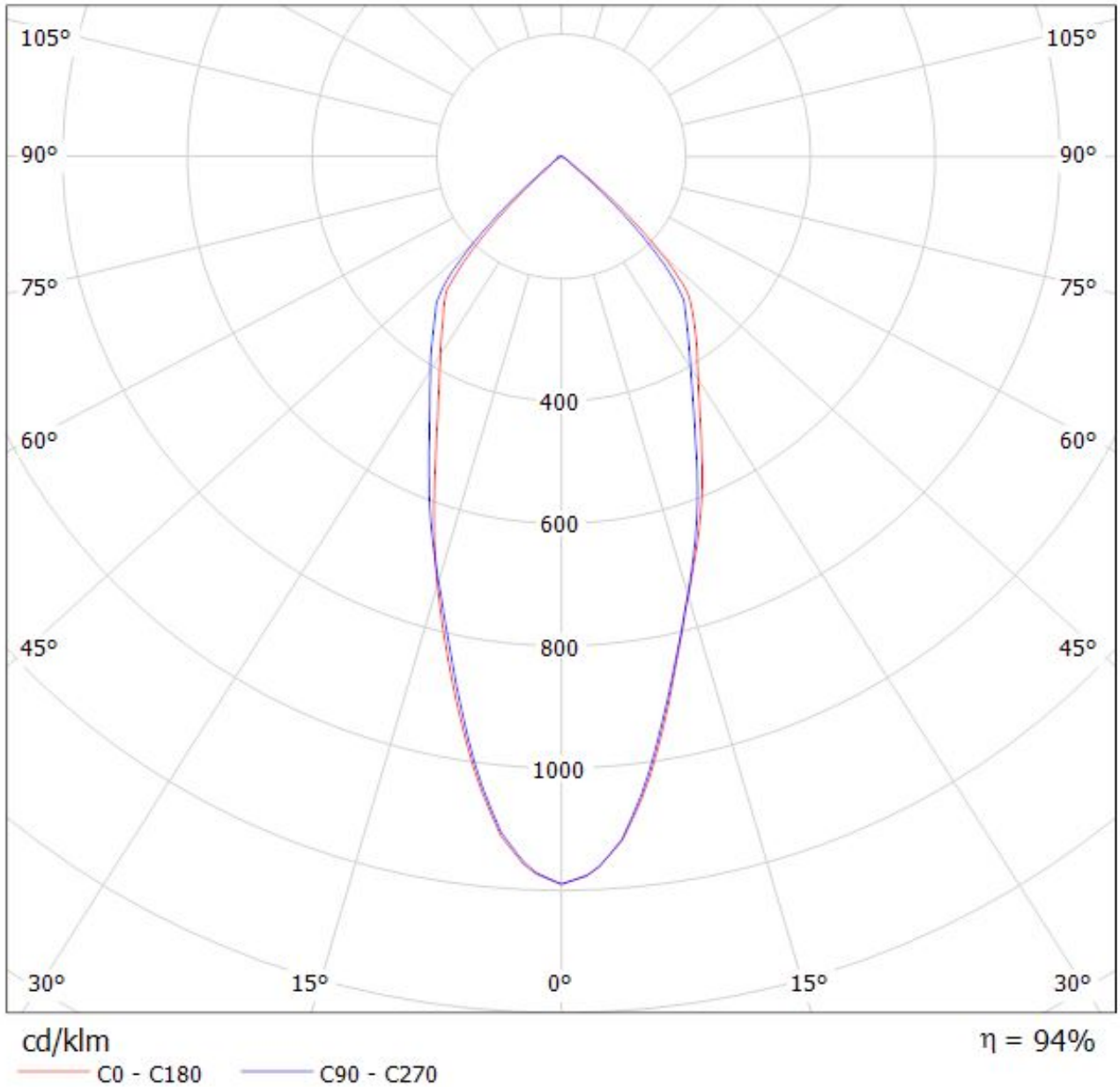

Luminaire: LEDiL Oy F13402_ANGELINA-W_(NSBxL121A) Eff.90.9%

Lamps: 1 x NICHIA_NSBxL121A_(NSBLL121AE)_805.561lm@250mA_CCT=3000K_P=7.3681W_I=249.8mA

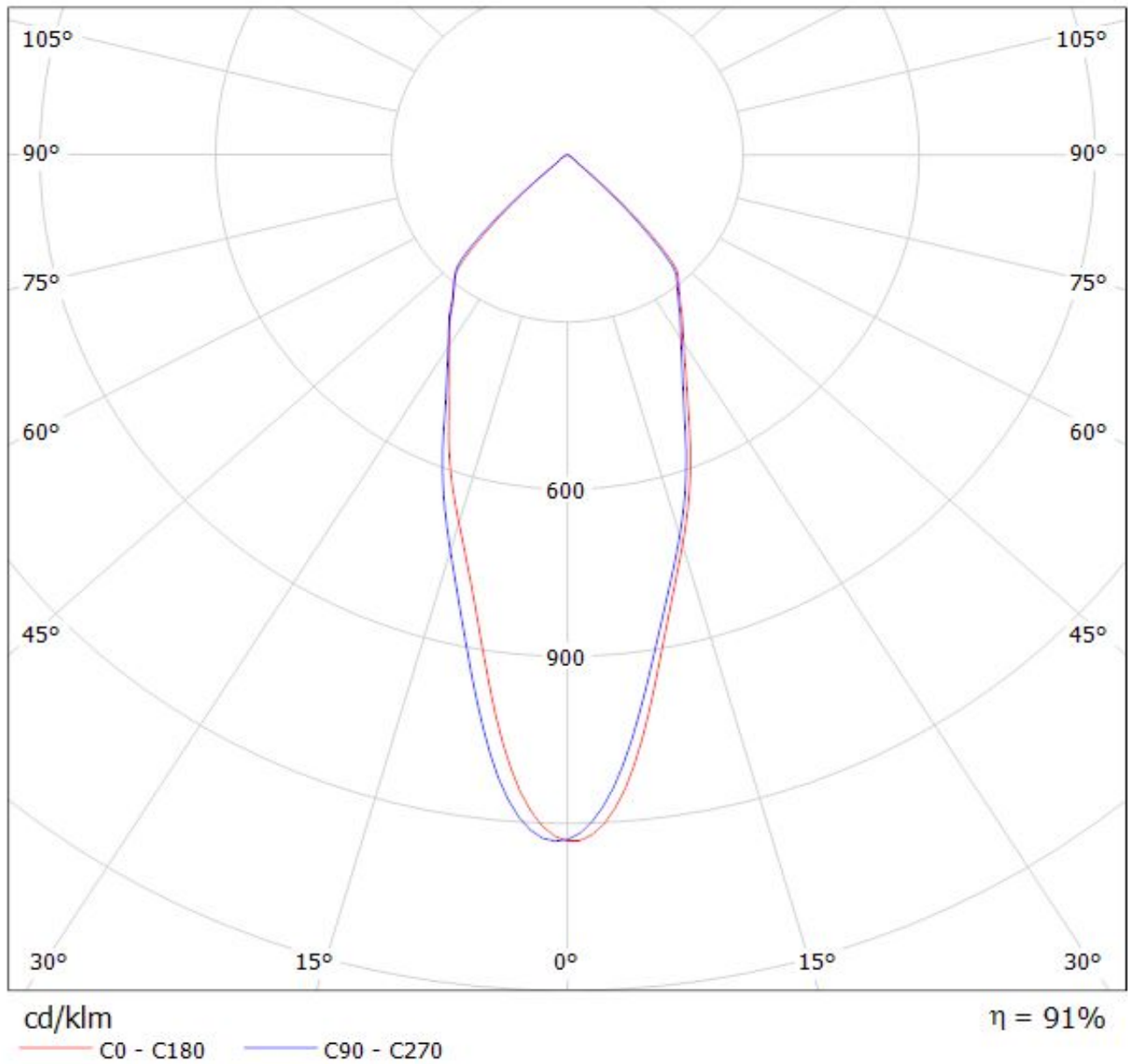

Luminaire: LEDiL Oy F13402_ANGELINA-W_(NSBxL121A)

Lamps: 1 x Nichia_NSBxL121A_914.478lm@250mA_P=7.56872W_I=249.9mA

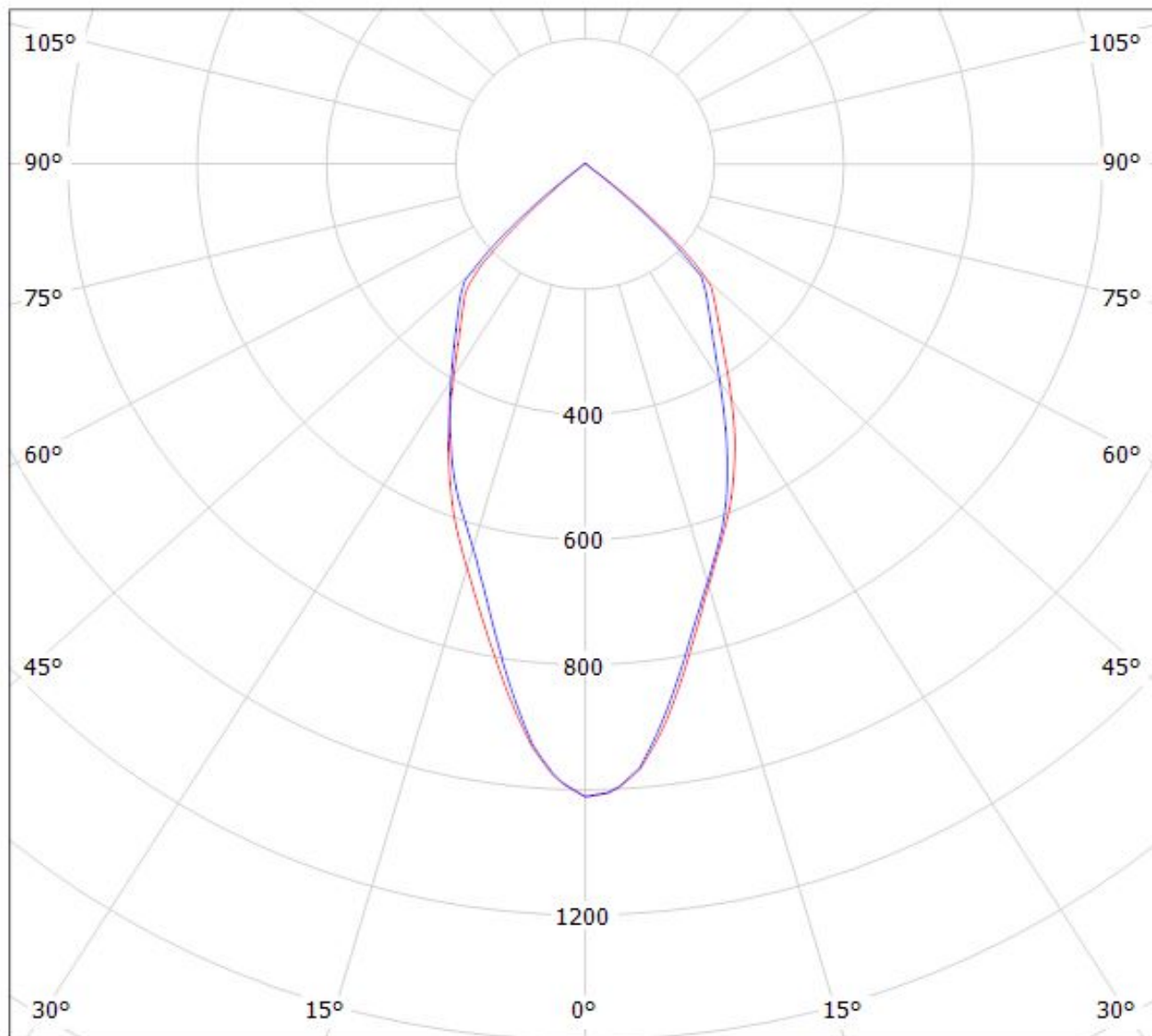

cd/klm

— C0 - C180

— C90 - C270

$\eta = 94\%$

Luminaire: Ledil F13402_ANGELINA-W_(NVCLL024Z+TE)

Lamps: 1 x Nichia_NVCLL024Z_+2213382-2_+2213194-1_971.485lm@250mA_CCT=3000K_P=8W_I=0.25A

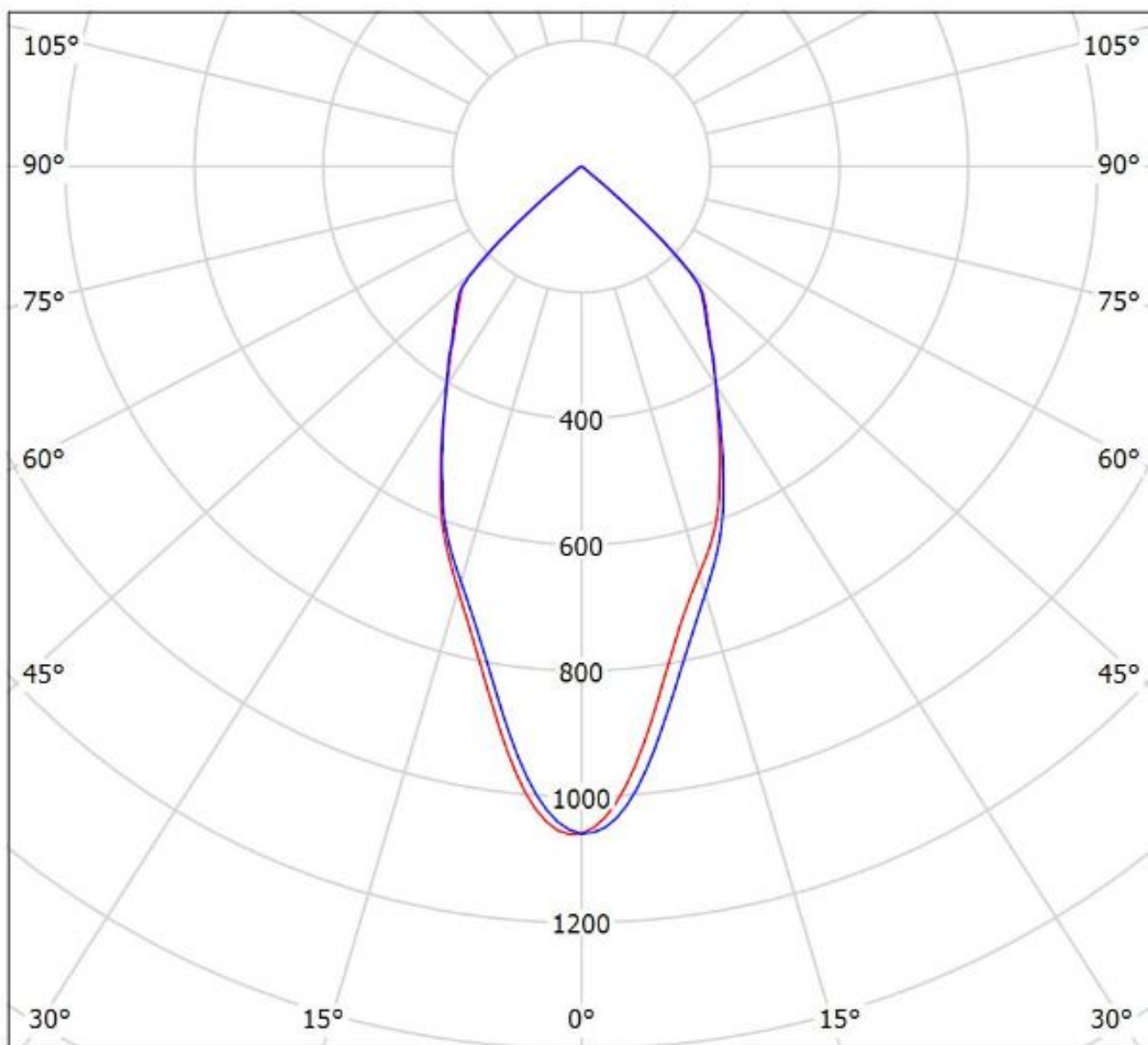

cd/klm

— C0 - C180 — C90 - C270

$\eta = 92\%$

Luminaire: LEDiL Oy F13402_ANGELINA-W_(PrevaLED_LES9) Eff. 93%

Lamps: 1 x PrevaLED_LES9_(PL-CORE-1100-830-Z3)_507.9lm@100mA_P=4.5039W_I=100.1mA

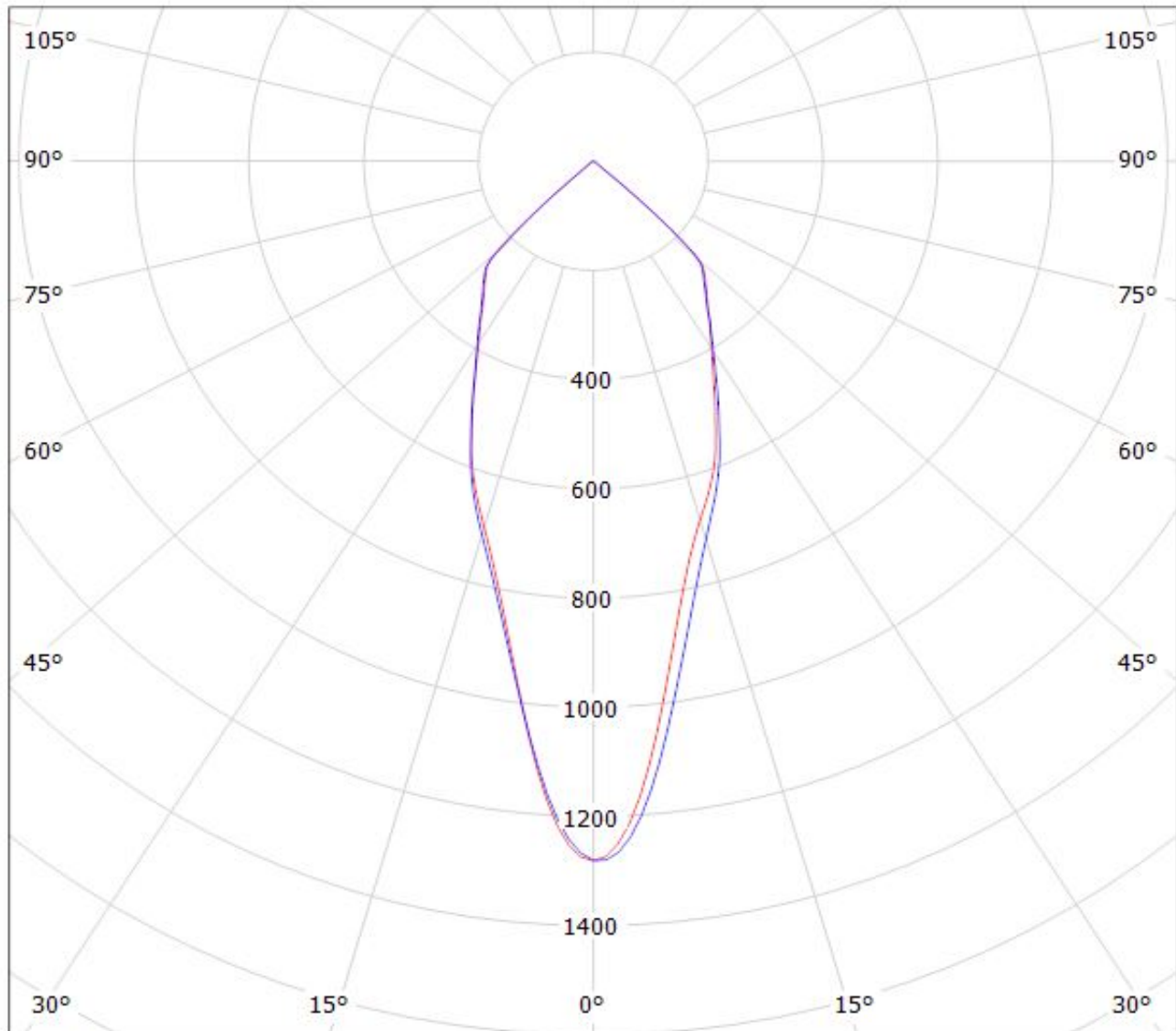

cd/klm

— C0 - C180

— C90 - C270

$\eta = 94\%$

Luminaire: LEDiL Oy F13402_ANGELINA-W_(PrevaLED_LES23) Eff. 94%

Lamps: 1 x OSRAM PrevaLED_LES23_(PL-CORE-5000-930-Z3)_1102.2lm@250mA_P=9.93654W_I=249.8mA

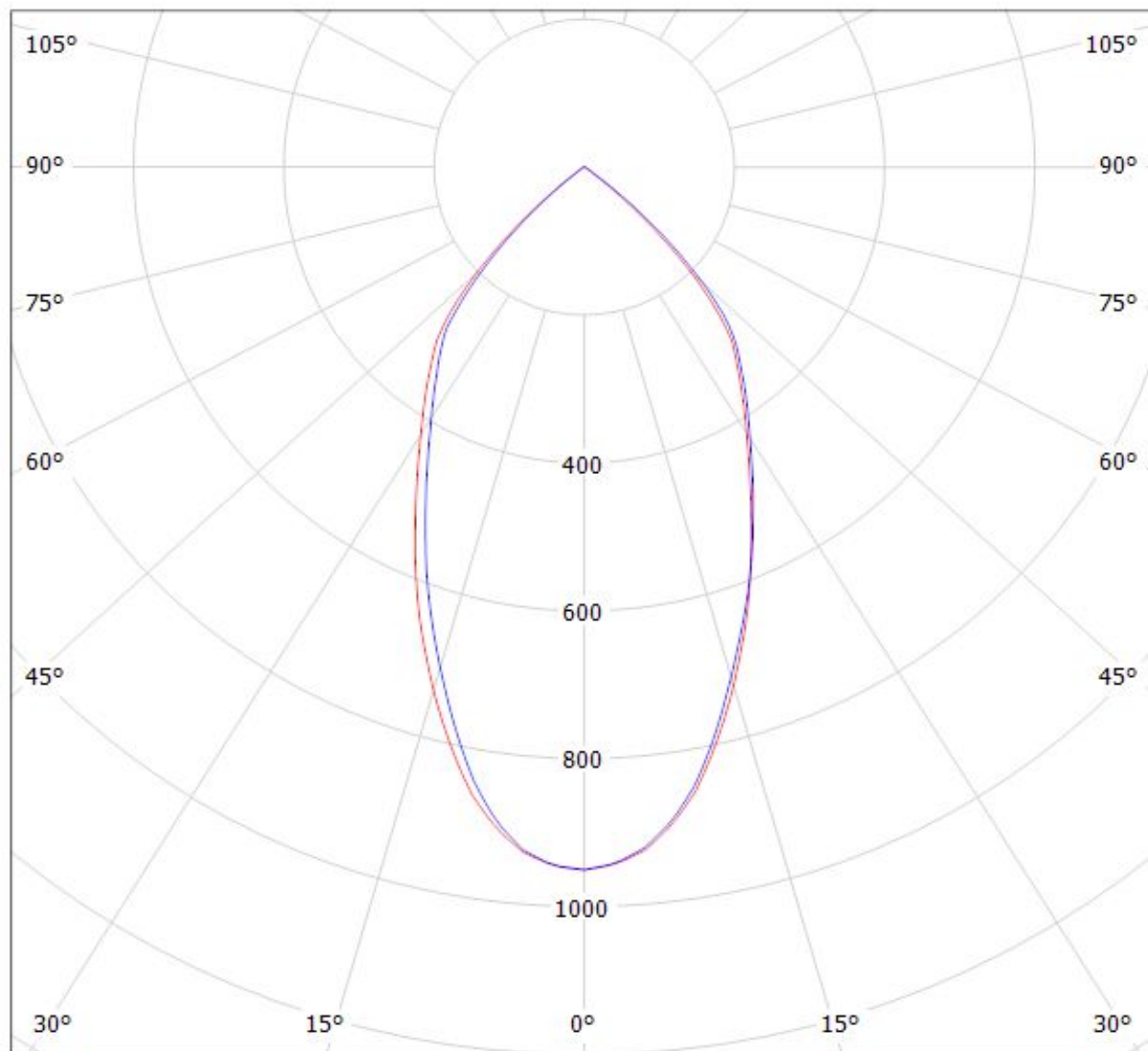

cd/klm

$\eta = 94\%$

— C0 - C180

— C90 - C270

Luminaire: LEDiL Oy F13402_ANGELINA-W_(PrevaLED_LES19)

Lamps: 1 x PrevaLED_LES19_(PL-CORE-2000-830-Z3)_1333.47lm@250mA_P=10.4584W_I=249.8mA

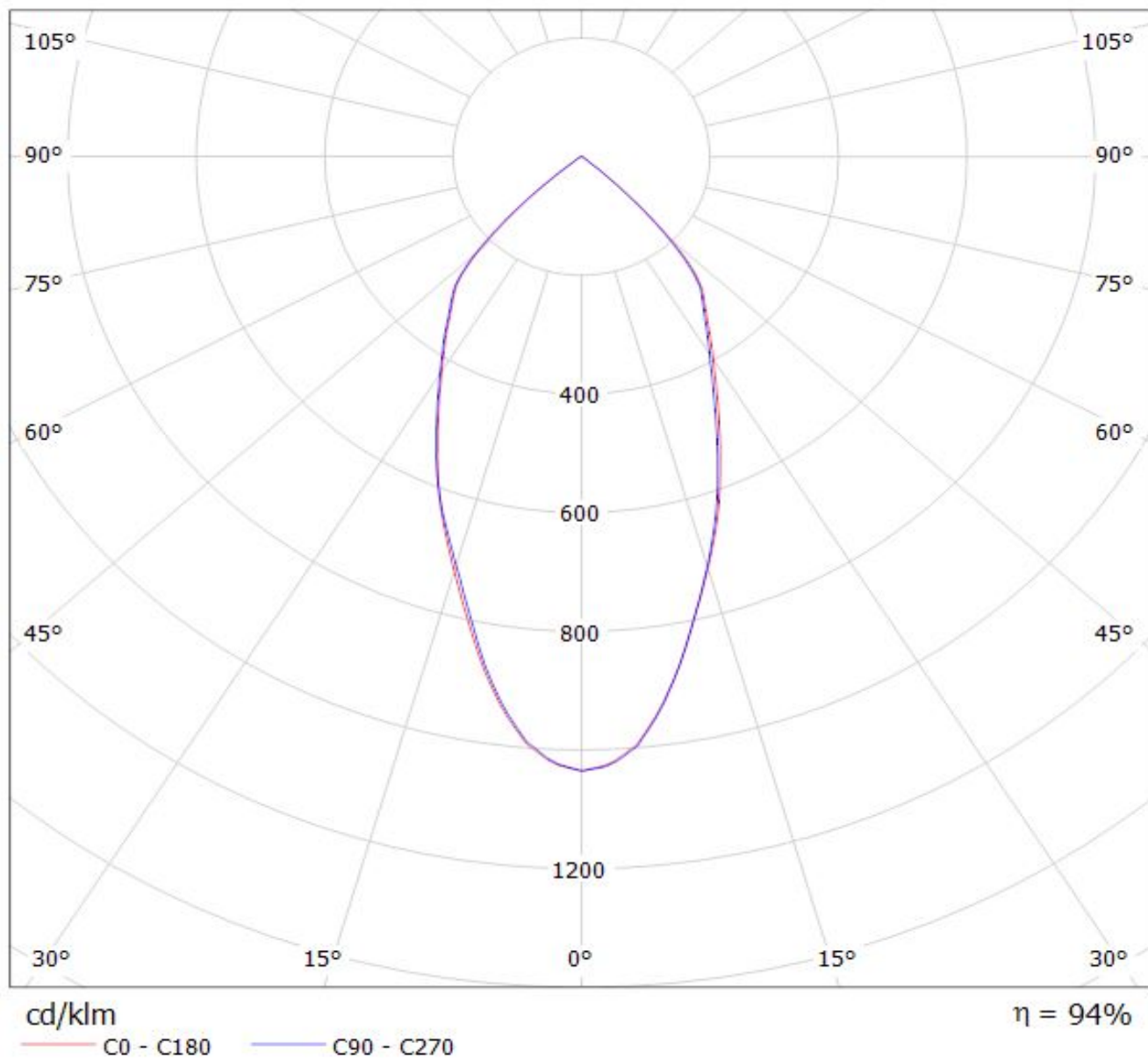

Luminaire: LEDil Oy F13402_ANGELINA-W_(Soleriq_S13) Efficiency=94%
Lamps: 1 x Osram Soleriq S13 (GW KAGHB1.EM) 855lm @ 250mA CCT=3100K P=7.5W I=250mA

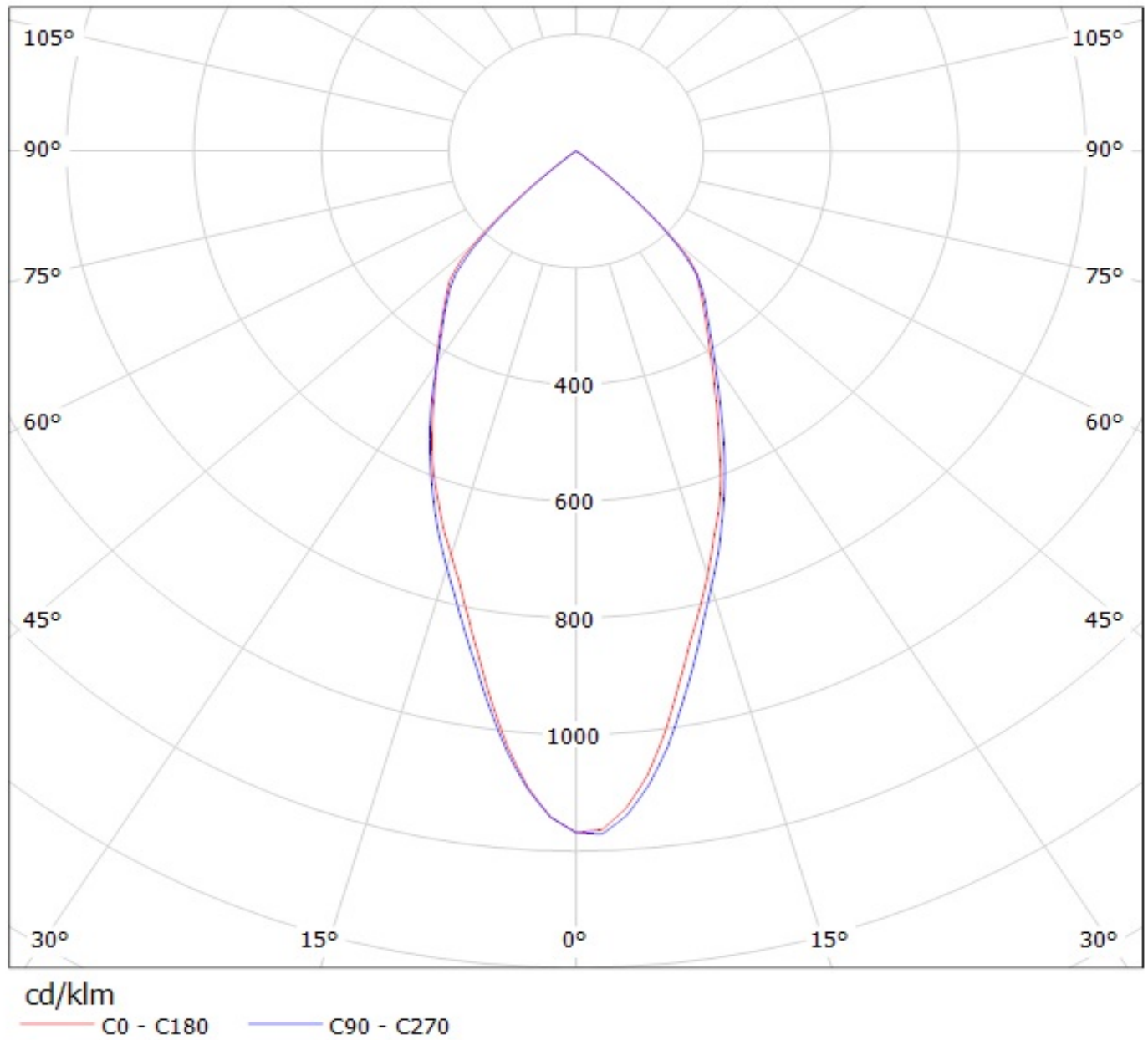

Luminaire: LEDiL Oy F13402_ANGELINA-W_(SOLERIQ_S19_&_TE_2213407-2)

Lamps: 1 x OSRAM_SOLERIQ_S19_(GW_KAHJB1.EM)_1393.62lm@250mA_CCT=3000K_P=10.5683W_I=249.8mA

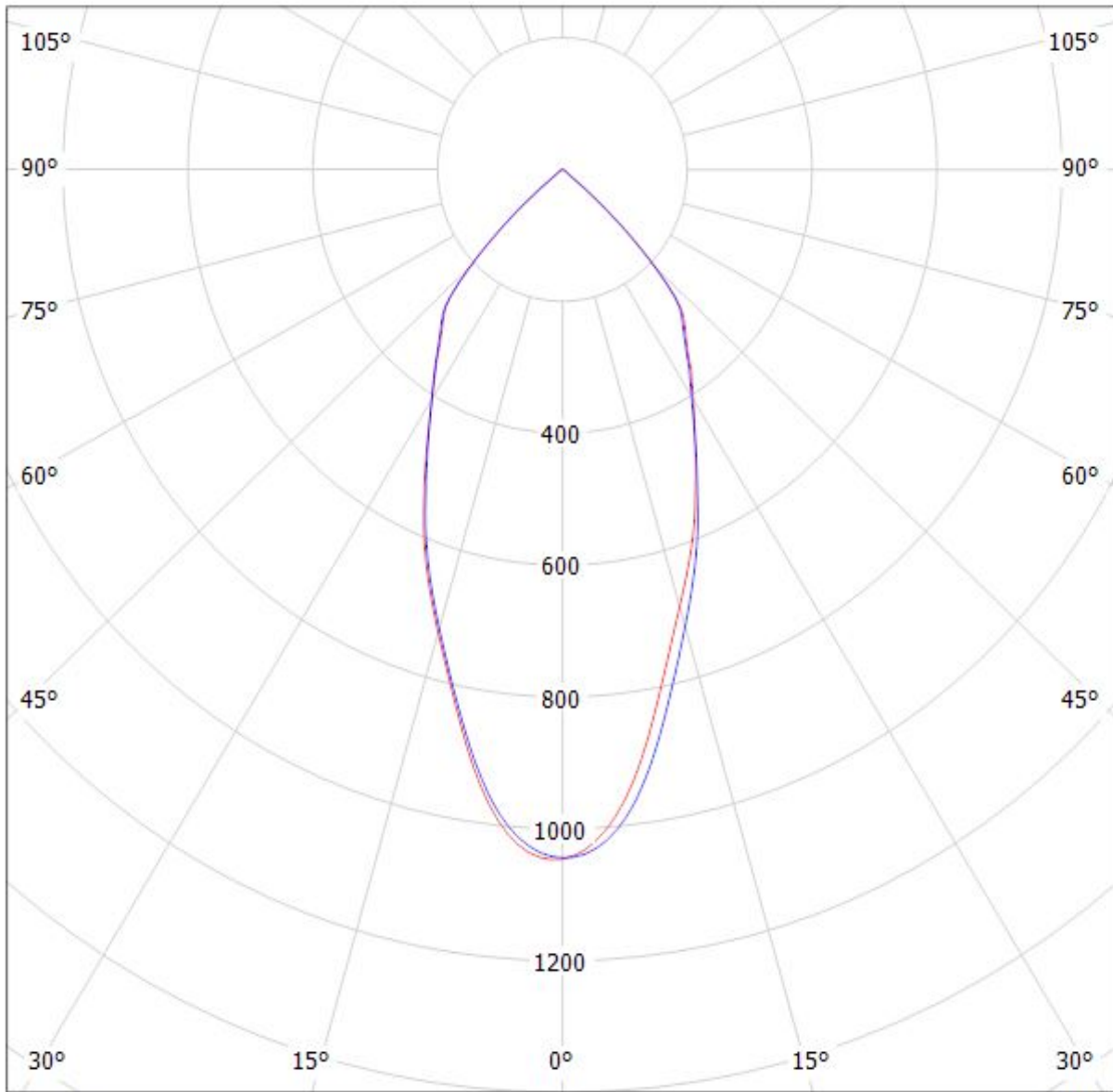

cd/klm

— C0 - C180 — C90 - C270

$\eta = 93\%$

Luminaire: LEDiL Oy F13402_ANGELINA-W_(LEP-800-827-C-AC)

Lamps: 1 x OSRAM PrevaLED Core AC (LEP-800-827-C-AC) 910lm@60mA U:230V P:14W

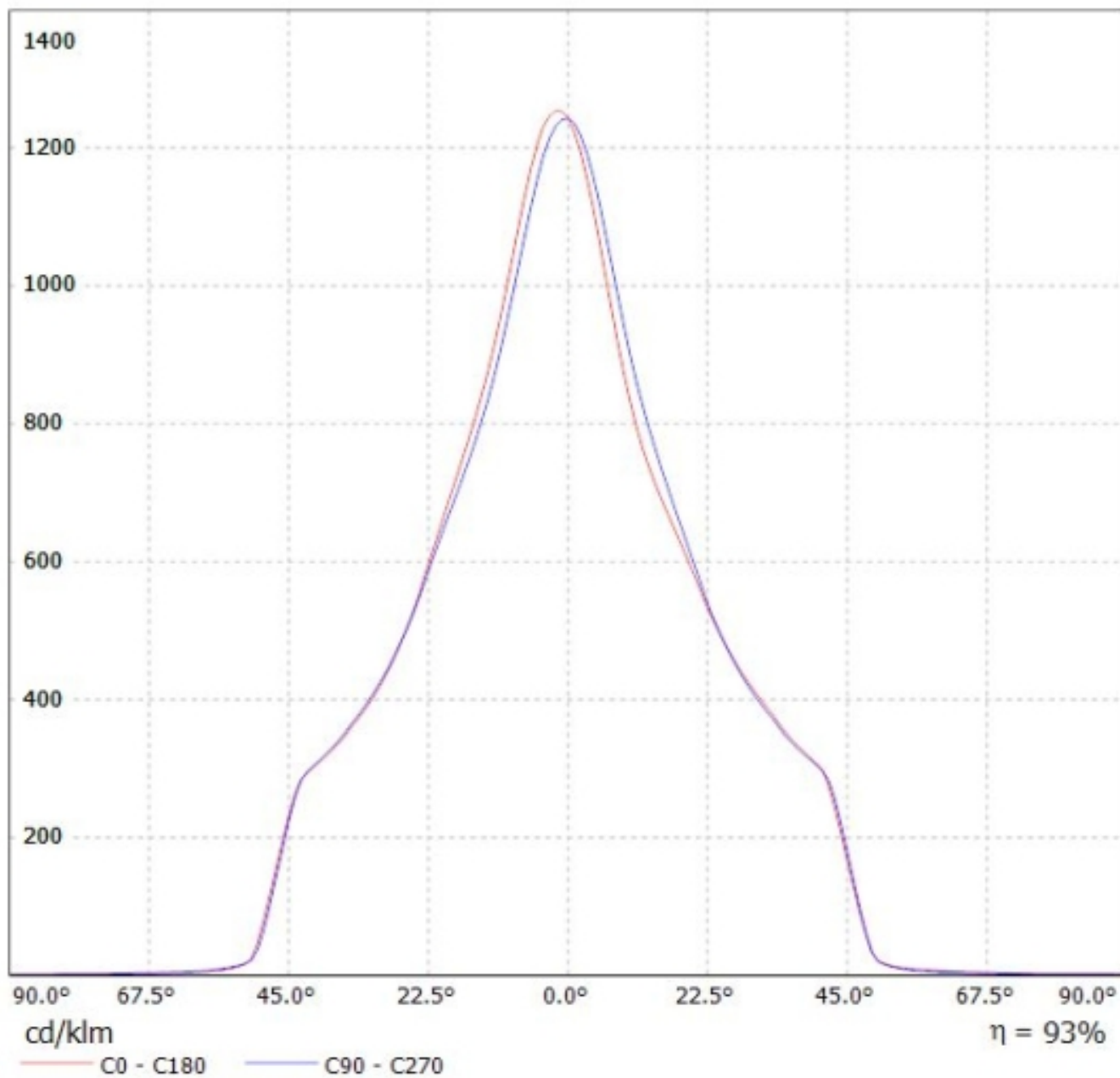

Luminaire: LEDiL Oy F13402_ANGELINA-W_(LEP-2000-827-C-AC)
Lamps: 1 x OSRAM PrevaLED Core AC (LEP-2000-827-C-AC)

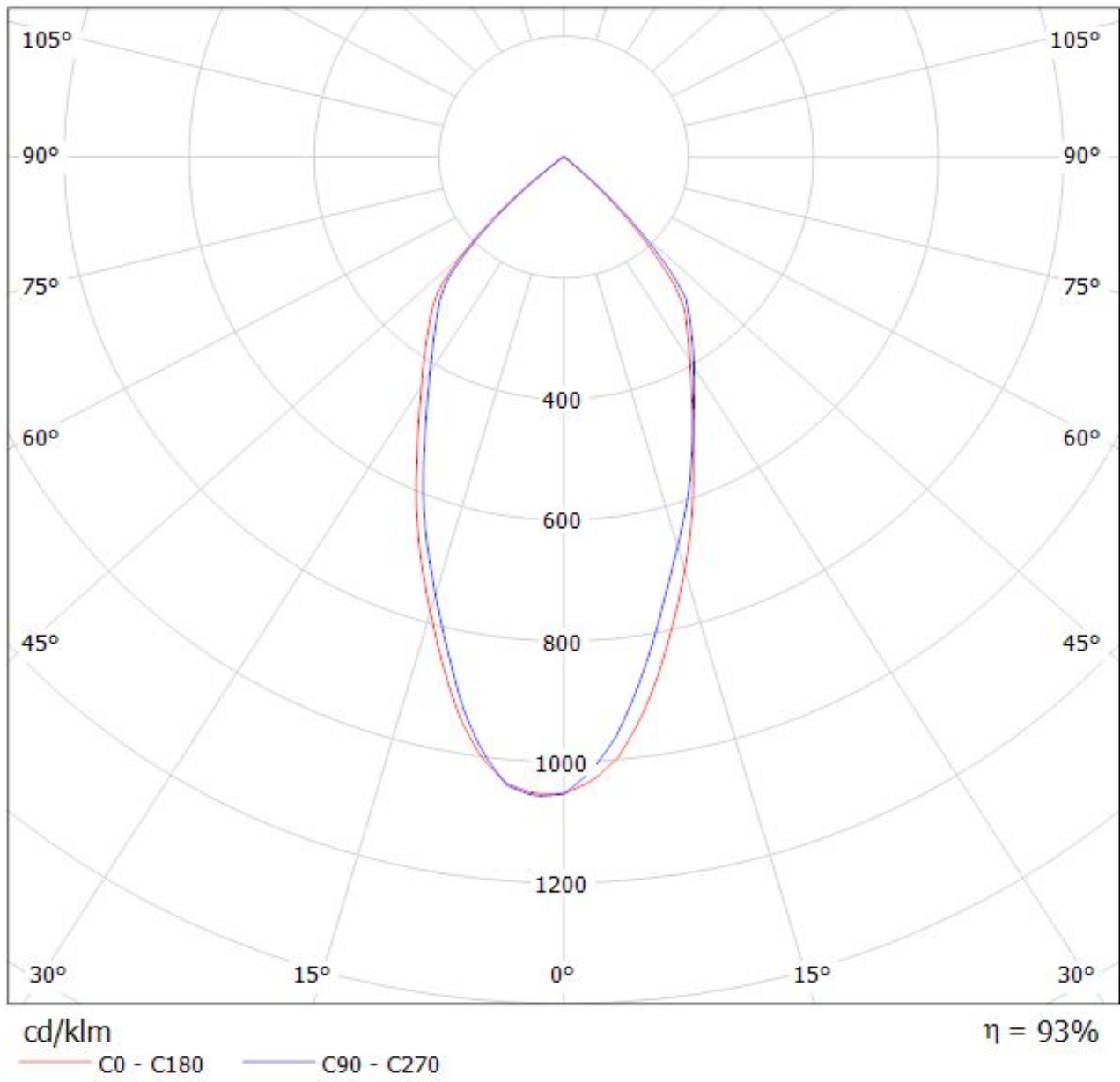

Luminaire: LEDiL Oy F13402_ANGELINA-W_(PrevaLED_Z4) Eff: 93%
Lamps: 1 x Osram_PrevaLED_CORE_Z4_(PL-CORE-3000-830-Z4)_1423.93lm@250mA_P=10.7652W_I=249.9mA

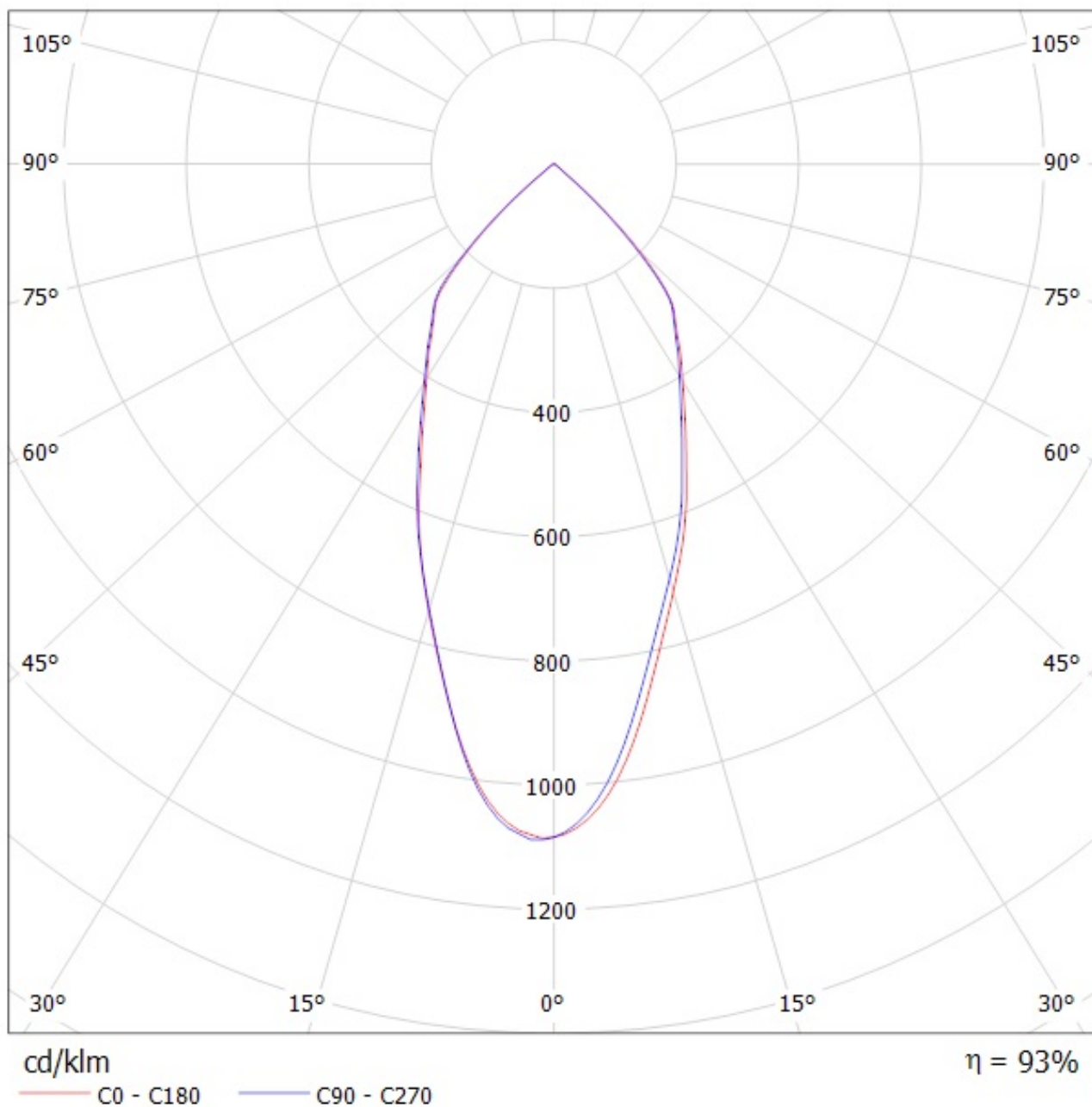

Luminaire: LEDiL Oy F13402_ANGELINA-W_(SOLERIQ_P13)

Lamps: 1 x SOLERIQ_P13_(GW_MAGMB1.EM)_1038.25lm@250mA_CCT=3000K_P=8.77223W_I=249.8mA

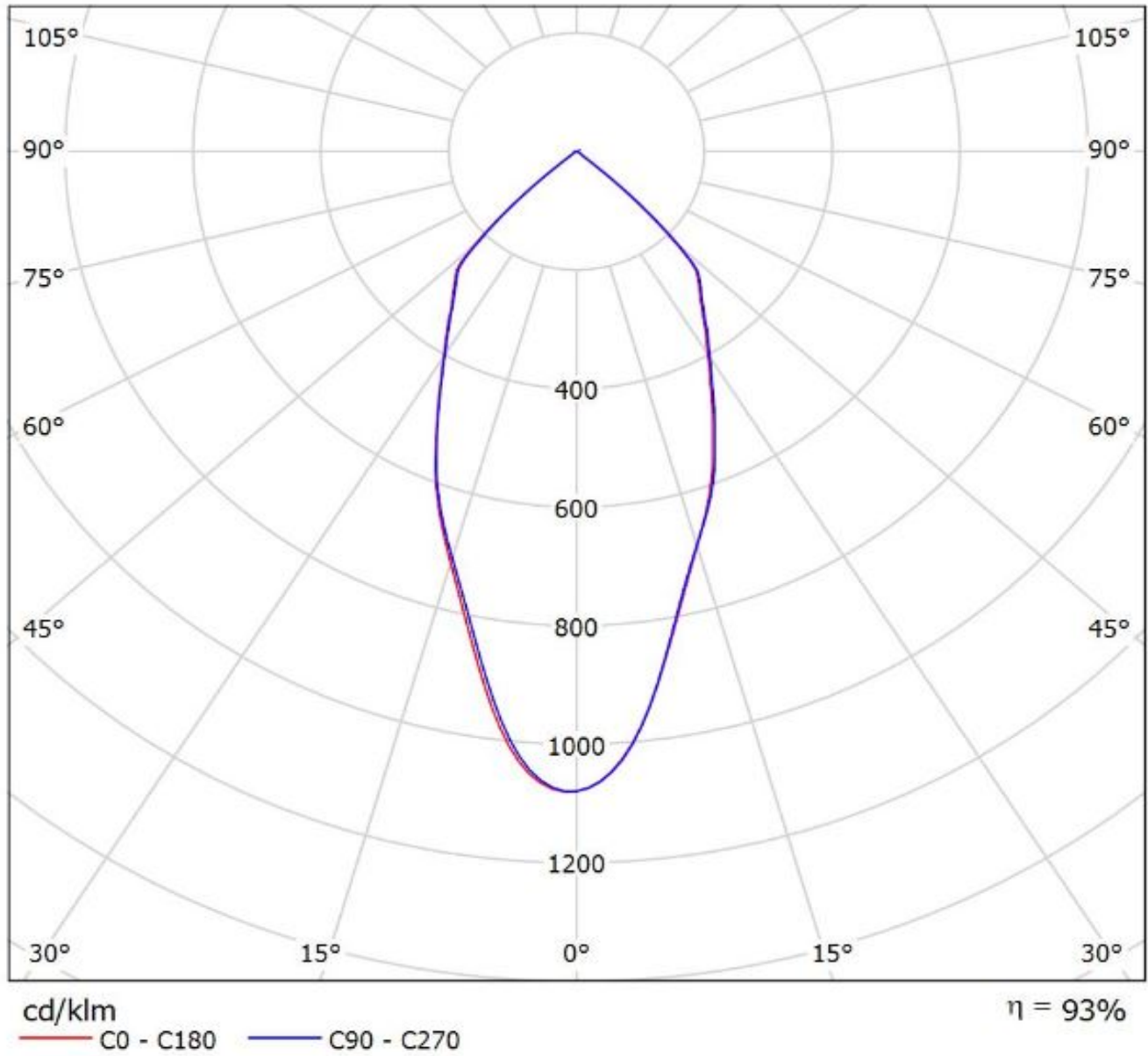

Luminaire: Ledil F13402_ANGELINA-W_(S13_Gen2+TE)

Lamps: 1 x Soleriq_S13_Gen2+_2213254-2+_2213194-1_1309.23lm@250mA_P=8.7840W_I=0.250A

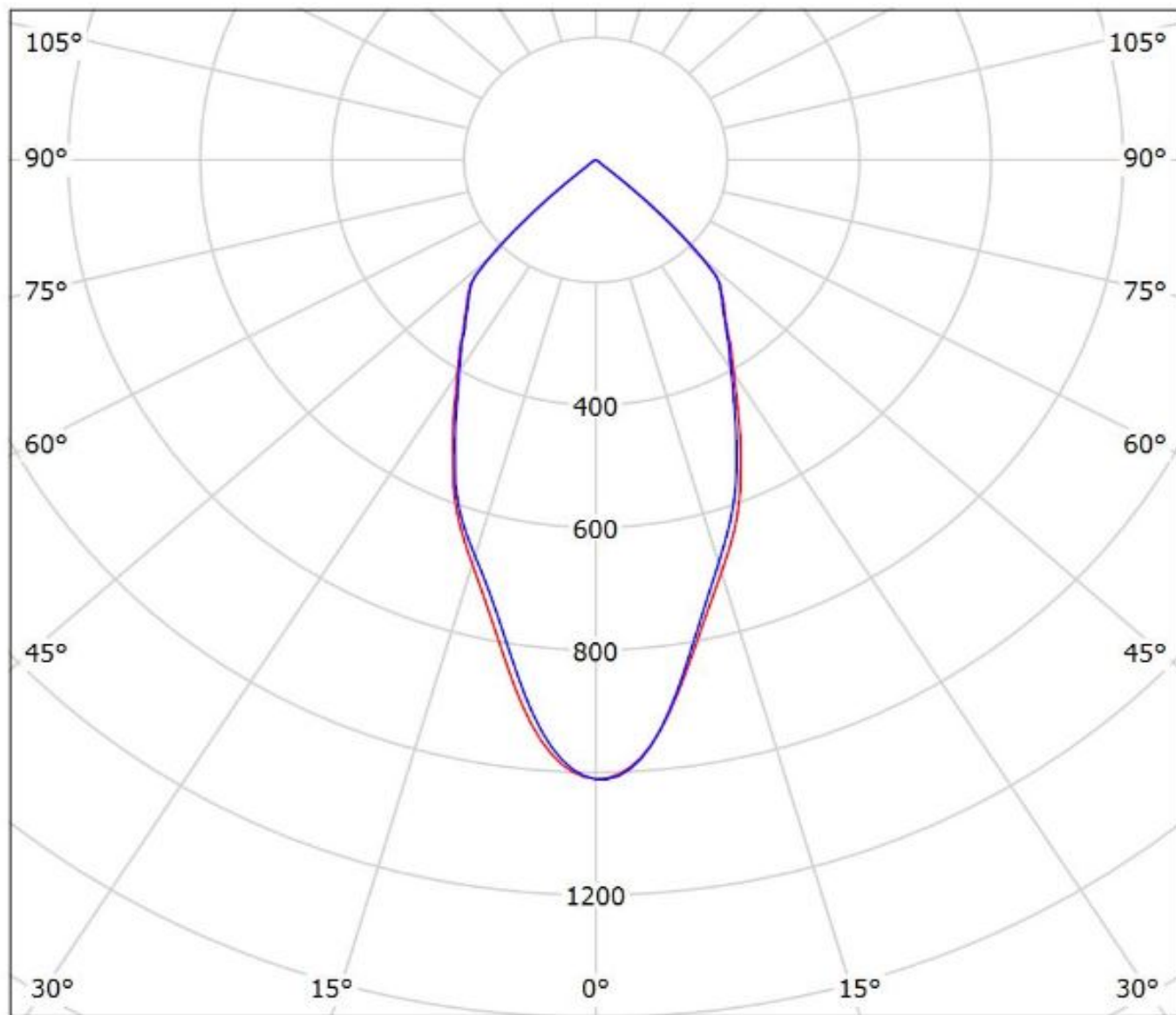

cd/klm

— C0 - C180

— C90 - C270

$\eta = 92\%$

Luminaire: Ledil F13402_ANGELINA-W_(S13_Gen2+IDEAL)

Lamps: 1 x Soleriq_S13_Gen2+_50-2103CT+_50-2100AN_1327.38lm@250mA_P=8.7850W_I=0.250A

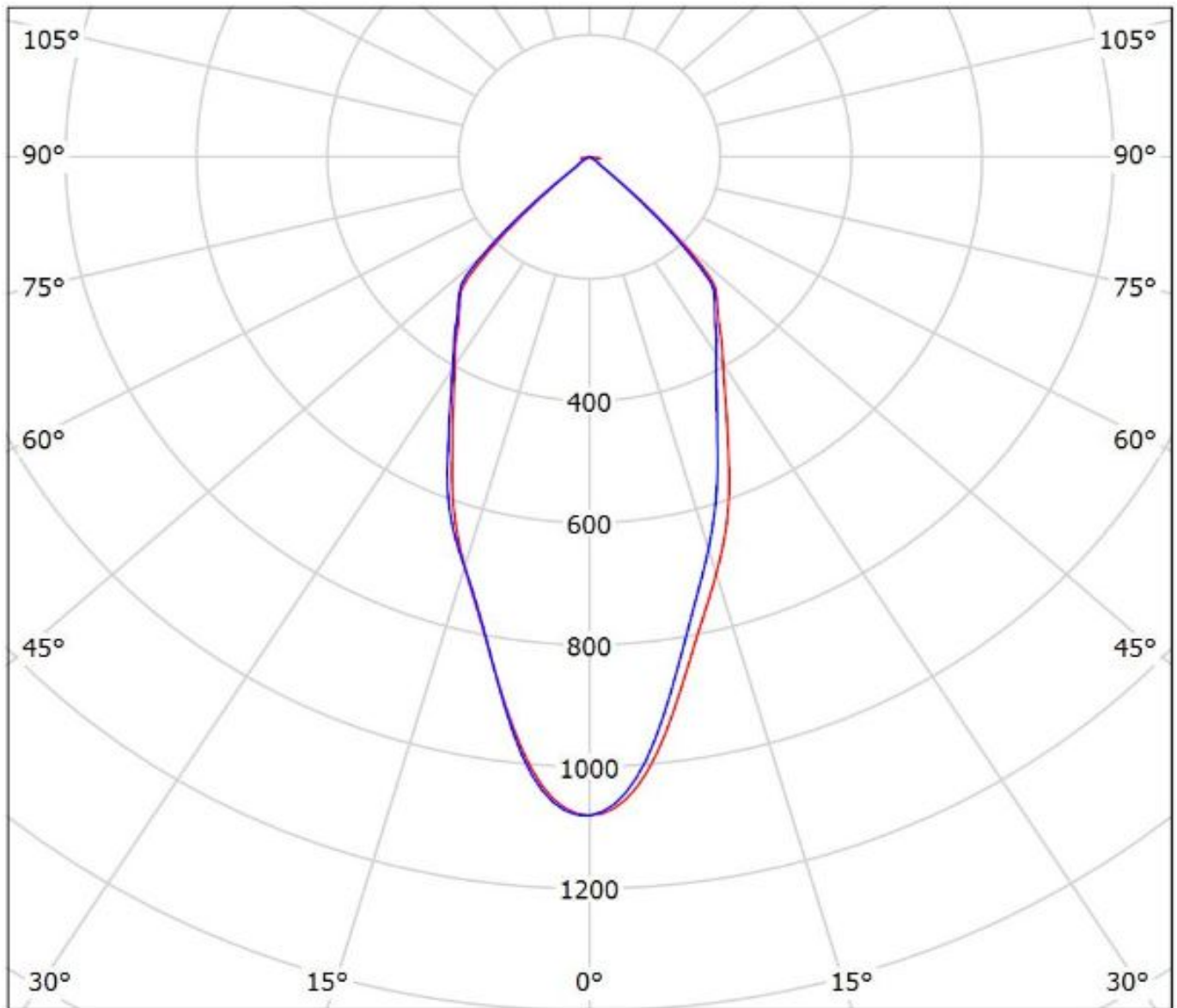

cd/klm

— C0 - C180 — C90 - C270

$\eta = 91\%$

Luminaire: LEDiL Oy F13402_ANGELINA-W_(FORTIMO_2000) Eff.90.5%
Lamps: 1 x PHILIPS Fortimo LED SLM 3000 28W/830 L19 G3 665.774lm@250mA CCT=3000K P=6W I=250mA

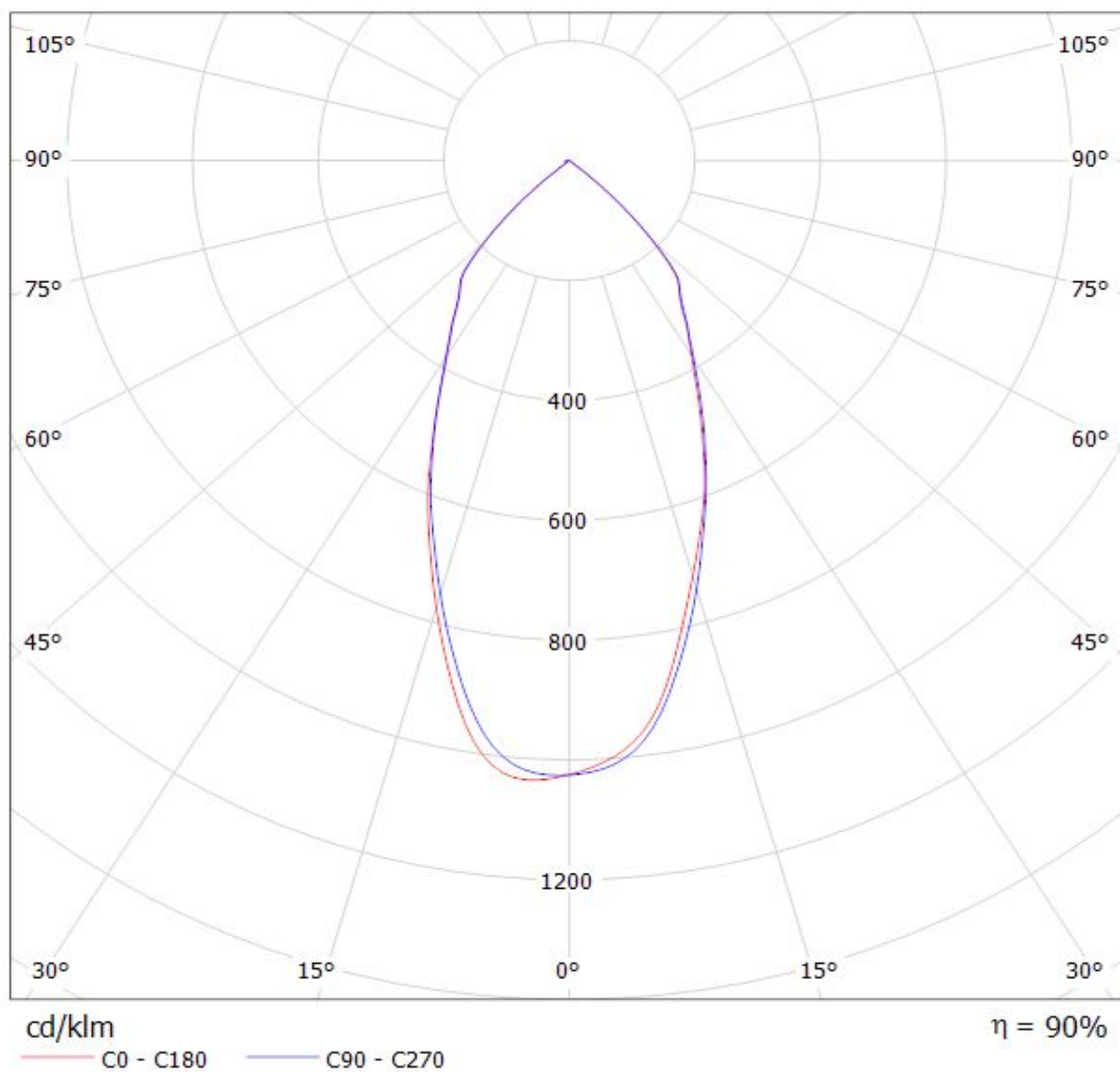

Luminaire: LEDiL Oy F13402_ANGELINA-W_(FORTIMO_3000) Eff.90.2%

Lamps: 1 x PHILIPS Fortimo LED SLM 3000 28W/830 L19 G3 1046.76lm@250mA CCT=3000K P=9W I=250mA

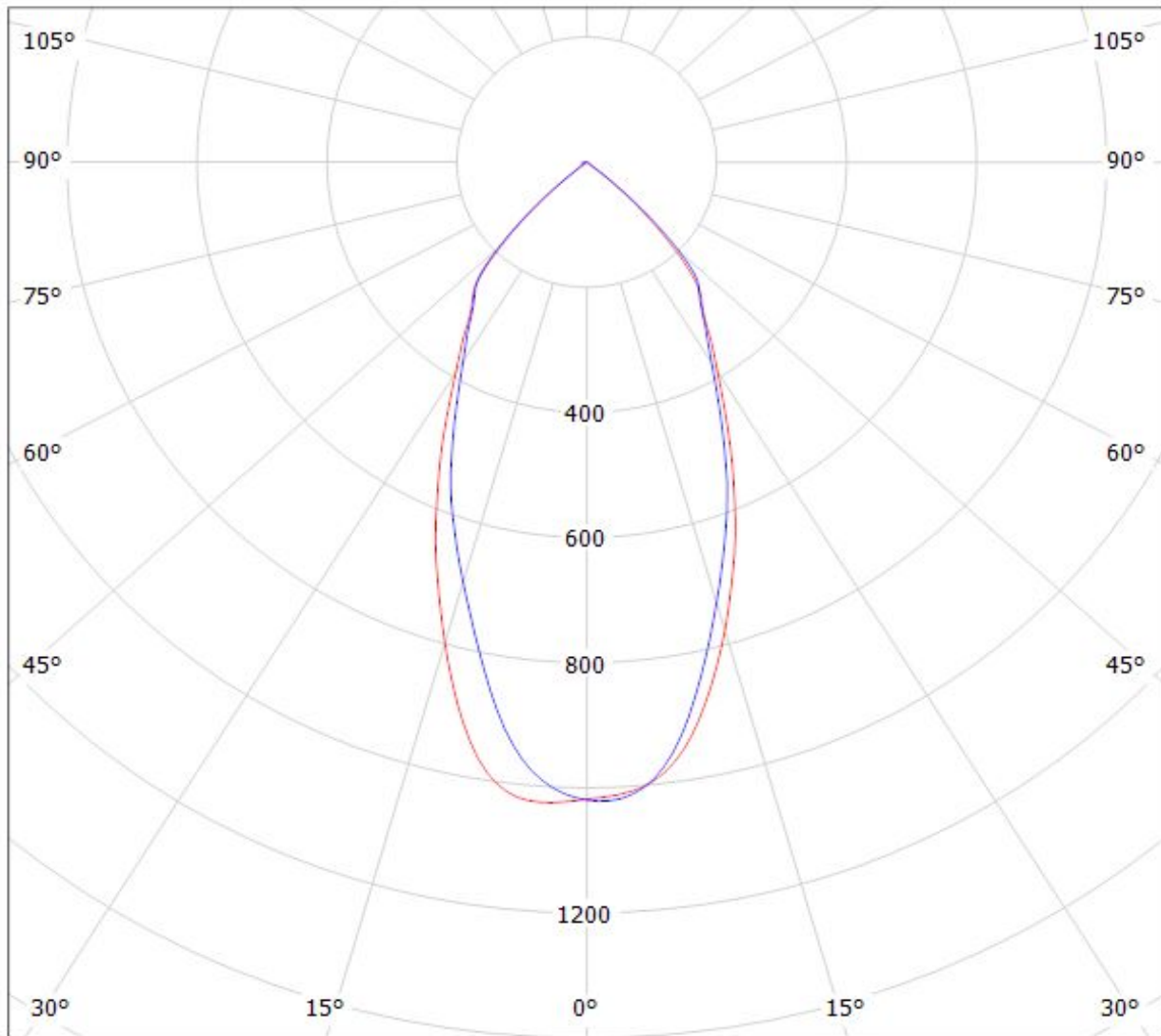

cd/klm

$\eta = 90\%$

— C0 - C180

— C90 - C270

Luminaire: LEDiL Oy F13402_ANGELINA-W_(FORTIMO_4500) Eff.89.0%
Lamps: 1 x PHILIPS Fortimo 4500

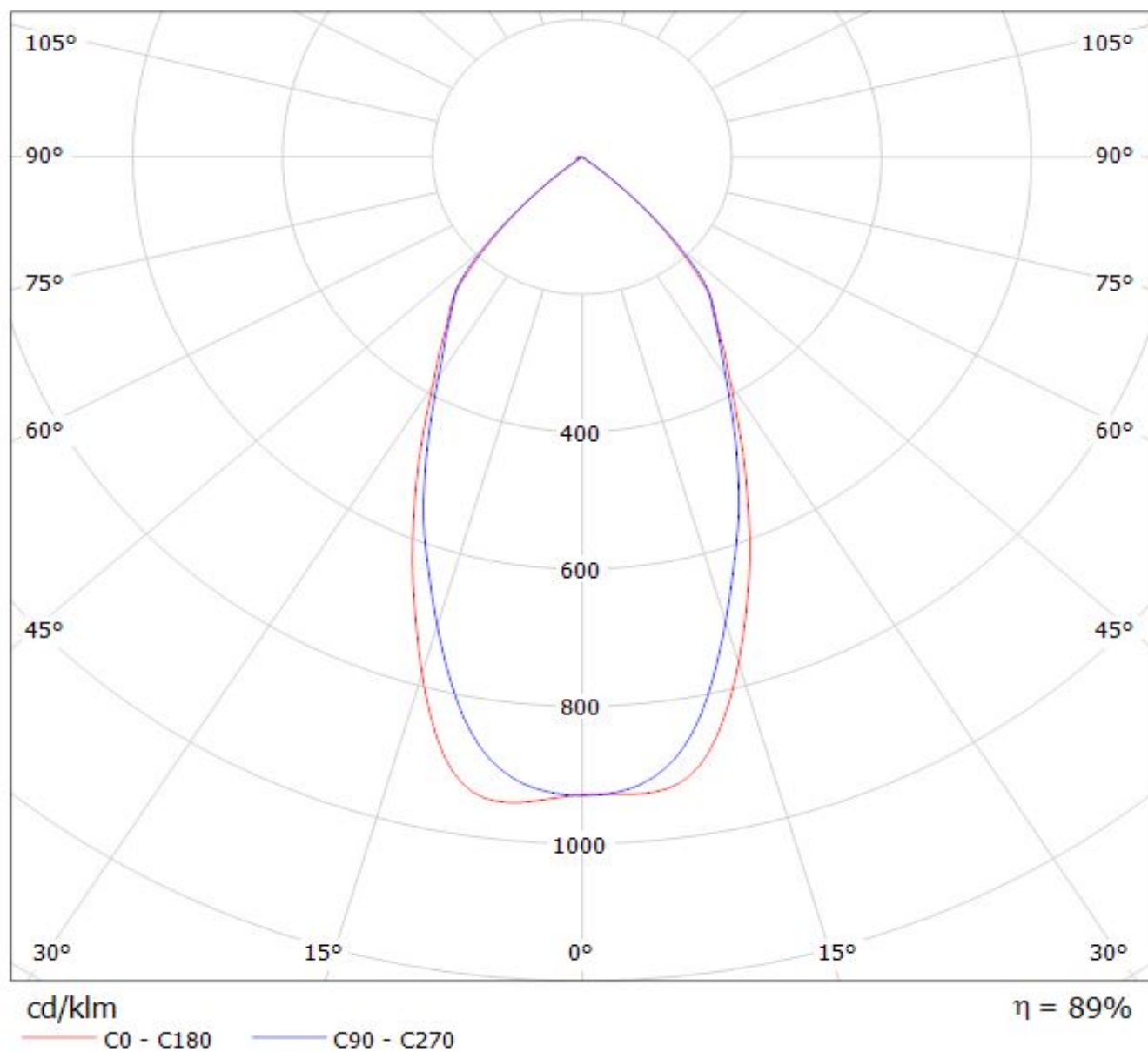

Luminaire: Ledil F13402_ANGELINA-W_(SLM_1211_L19_G6_+TE)

Lamps: 1 x Philips_Fortimo_SLM_1211_L19_G6_Standard_+_TE_OPTIC_CLIP_Z50_TYPE1:_2213194-1_1146.84lm@250mA_P=8.13175W_I=0.25A

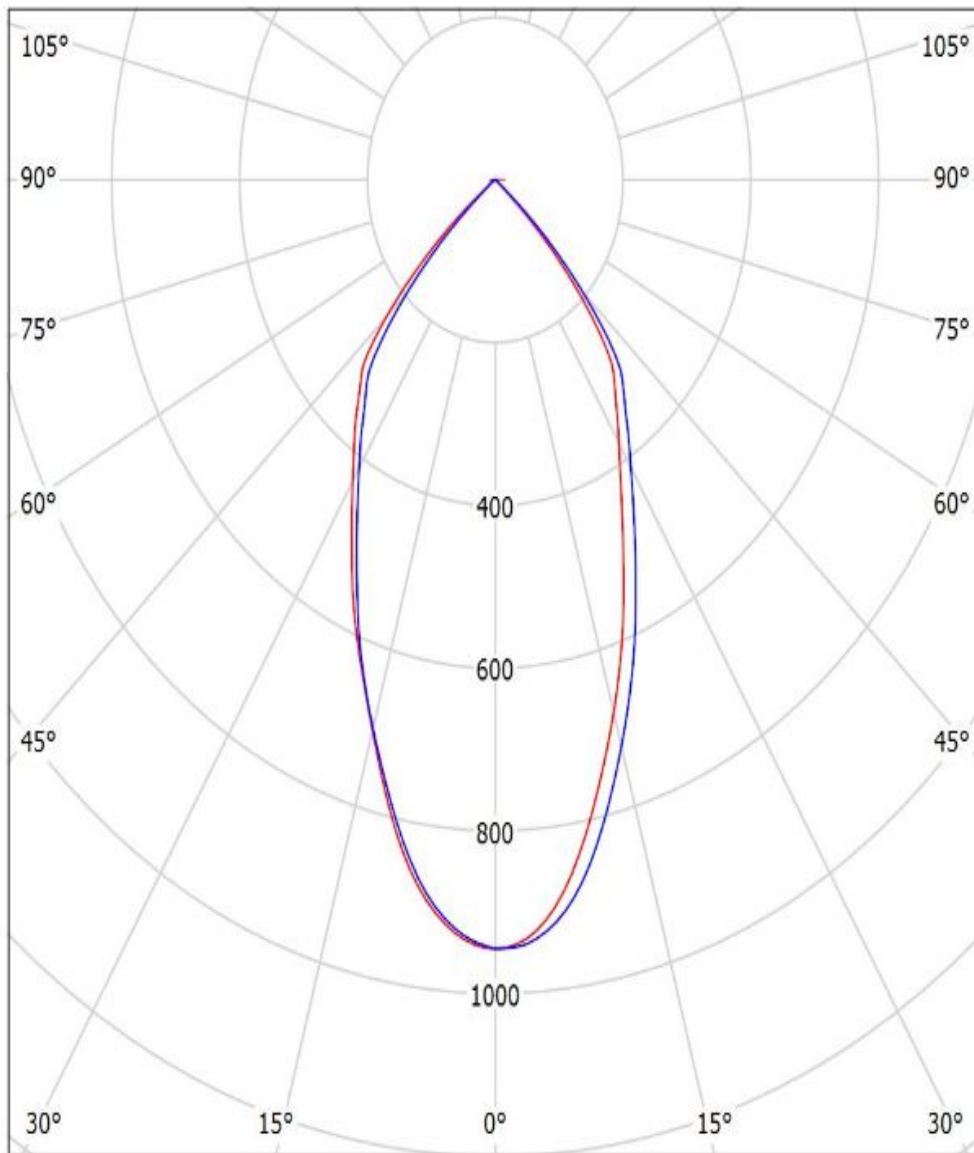

cd/klm

— C0 - C180 — C90 - C270

$\eta = 91\%$

Luminaire: LEDiL Oy F13402_ANGELINA-W_(Fortimo LED SLM 1100 lm 830 L9 G4)
Lamps: 1 x Fortimo LED SLM 1100 lm 830 L9 G4_1021.27lm@250mA_P=9.2431W_I=0.2498A

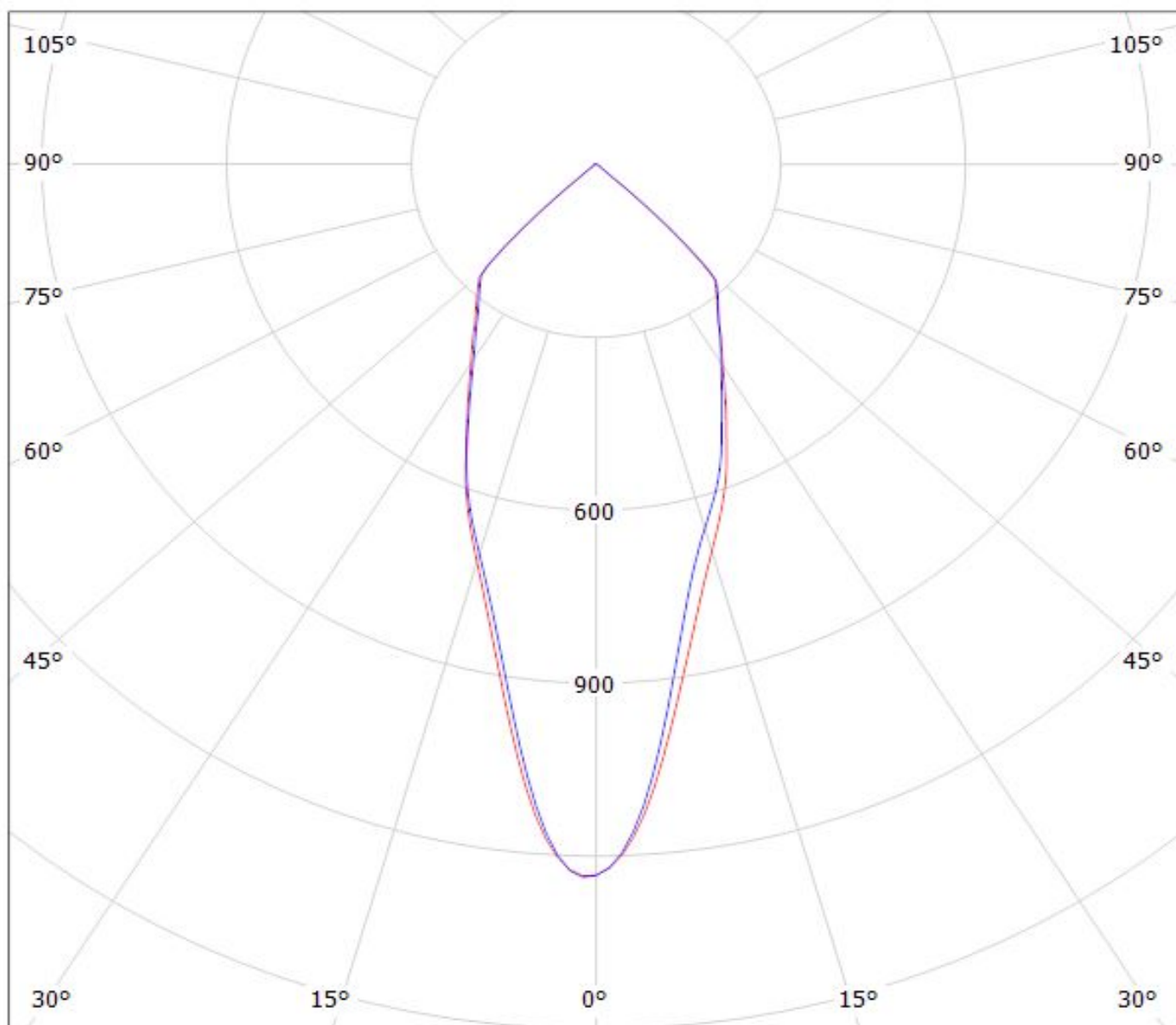

cd/klm

— C0 - C180 — C90 - C270

$\eta = 92\%$

Luminaire: LEDiL Oy F13402_ANGELINA-W_(Fortimo LED SLM L13 G4)

Lamps: 1 x Fortimo LED SLM L13 G4_1110.38lm@250mA_P=8.38454W_I=0.2498A

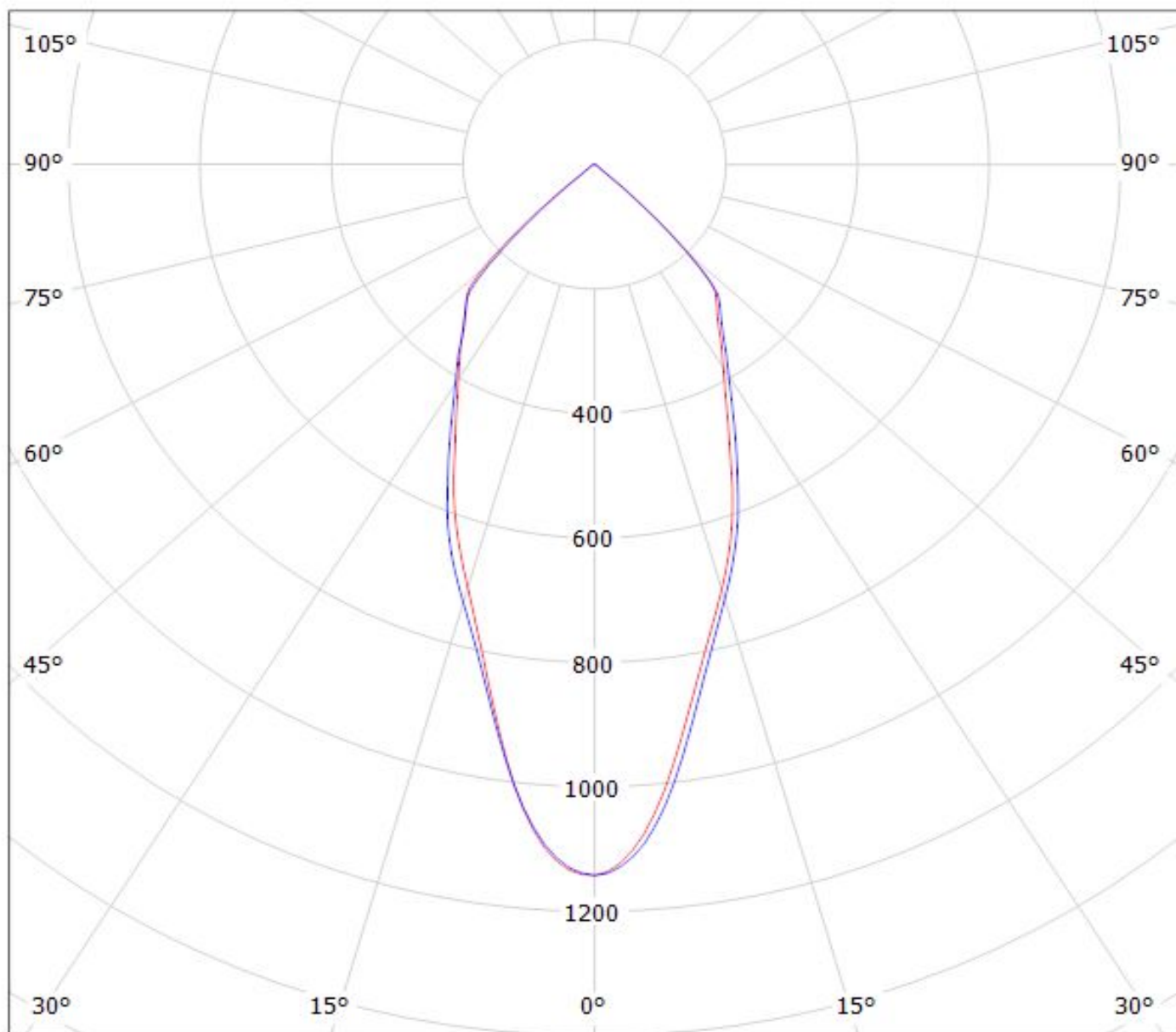

cd/klm

— C0 - C180

— C90 - C270

$\eta = 92\%$

Luminaire: LEDiL Oy F13402_ANGELINA-W_(Fortimo LED SLM L15 G4)
Lamps: 1 x Fortimo LED SLM L15 G4_1116.47lm@250mA_P=8.21168W_I=0.2498A

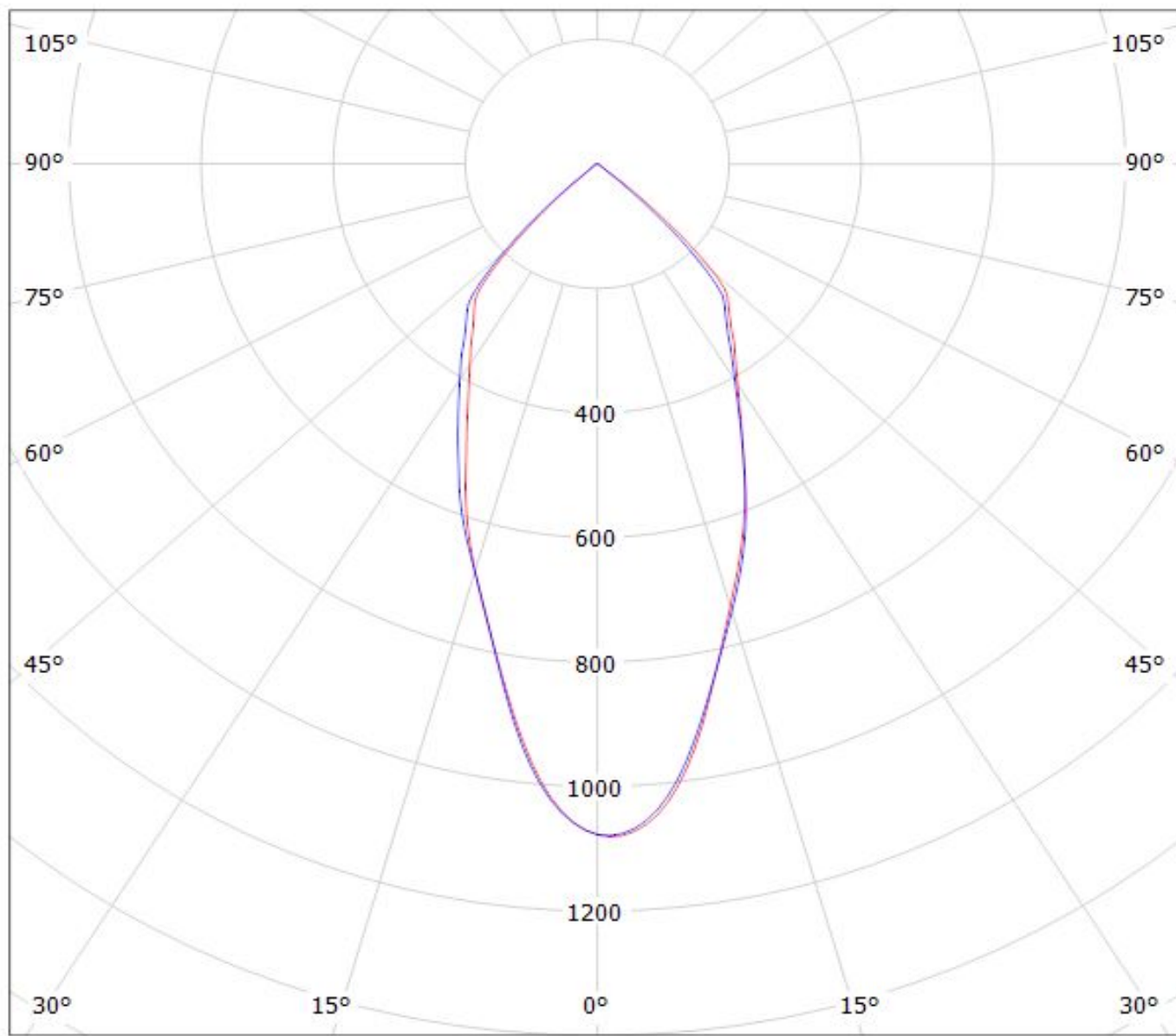

cd/klm

— C0 - C180 — C90 - C270

$\eta = 93\%$

Luminaire: LEDiL Oy F13402_ANGELINA-W_(Fortimo LED SLM L19 G4)

Lamps: 1 x Fortimo LED SLM L19 G4_1114.89lm@250mA_P=8.04906W_I=0.2498A

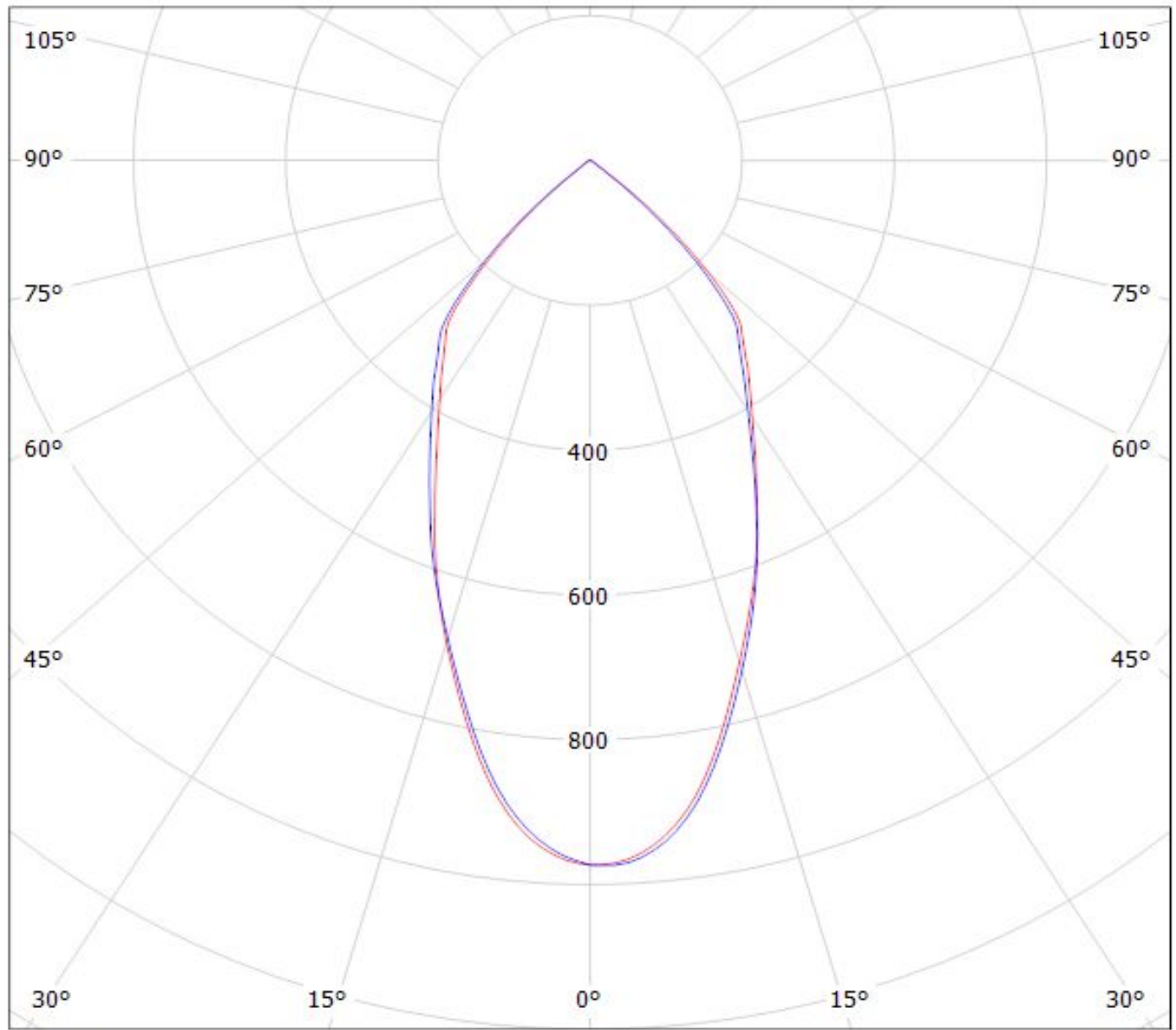

cd/klm

— C0 - C180

— C90 - C270

$\eta = 92\%$

Luminaire: LEDiL Oy F13402_ANGELINA-W_(SLM-G5-LES-9)_(Z50-Optic-Clip)
Lamps: 1 x Fortimo_SLM-G5-LES-9_1182.49lm@250mA_P=8.5848W_I=0.250A

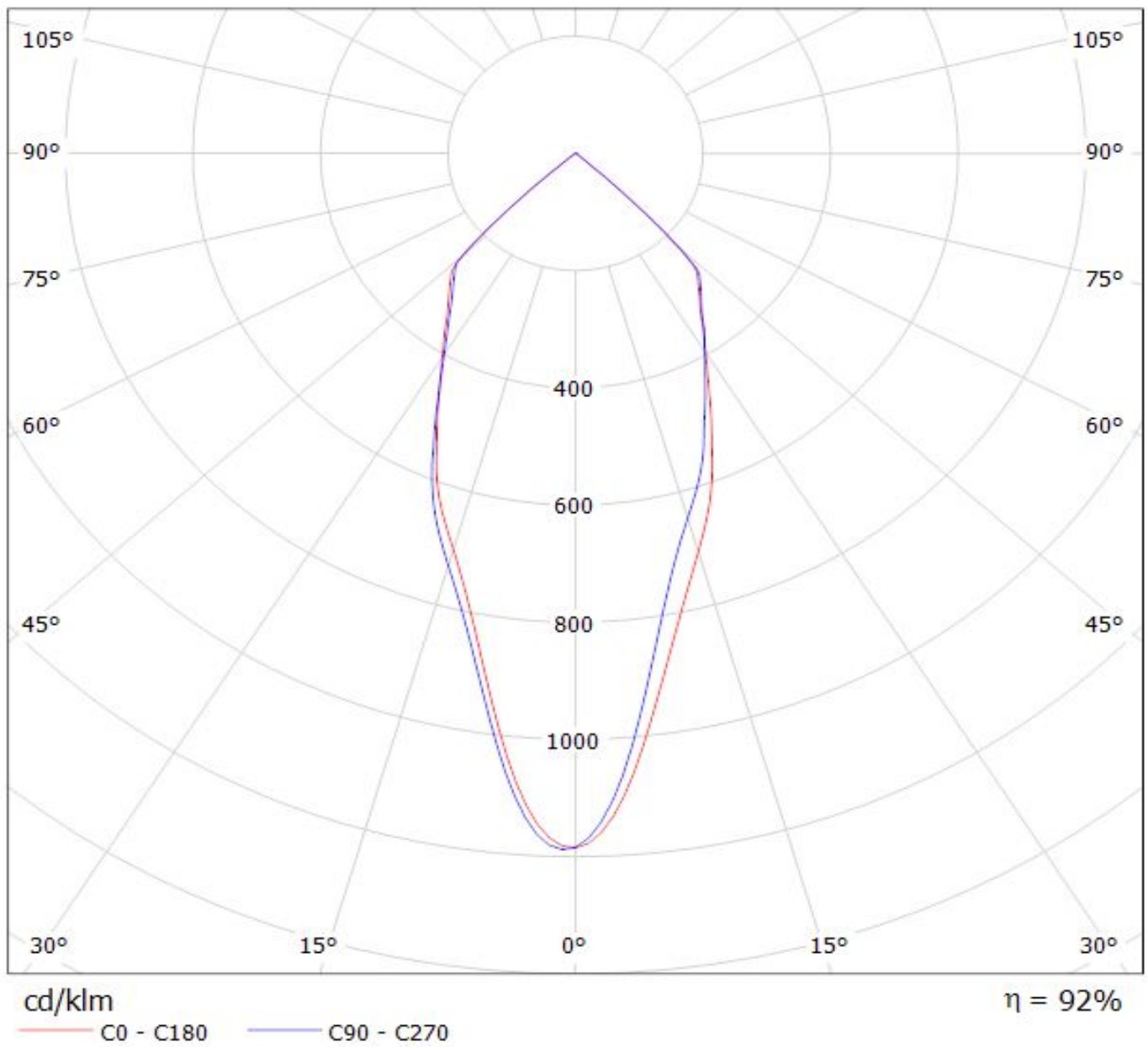

Luminaire: LEDiL Oy F13402_ANGELINA-W_(SLM-G5_LES-15)
Lamps: 1 x Fortimo_SLM-G5_LES-15_1257.61lm@250mA_P=8.1569W_I=0.250A

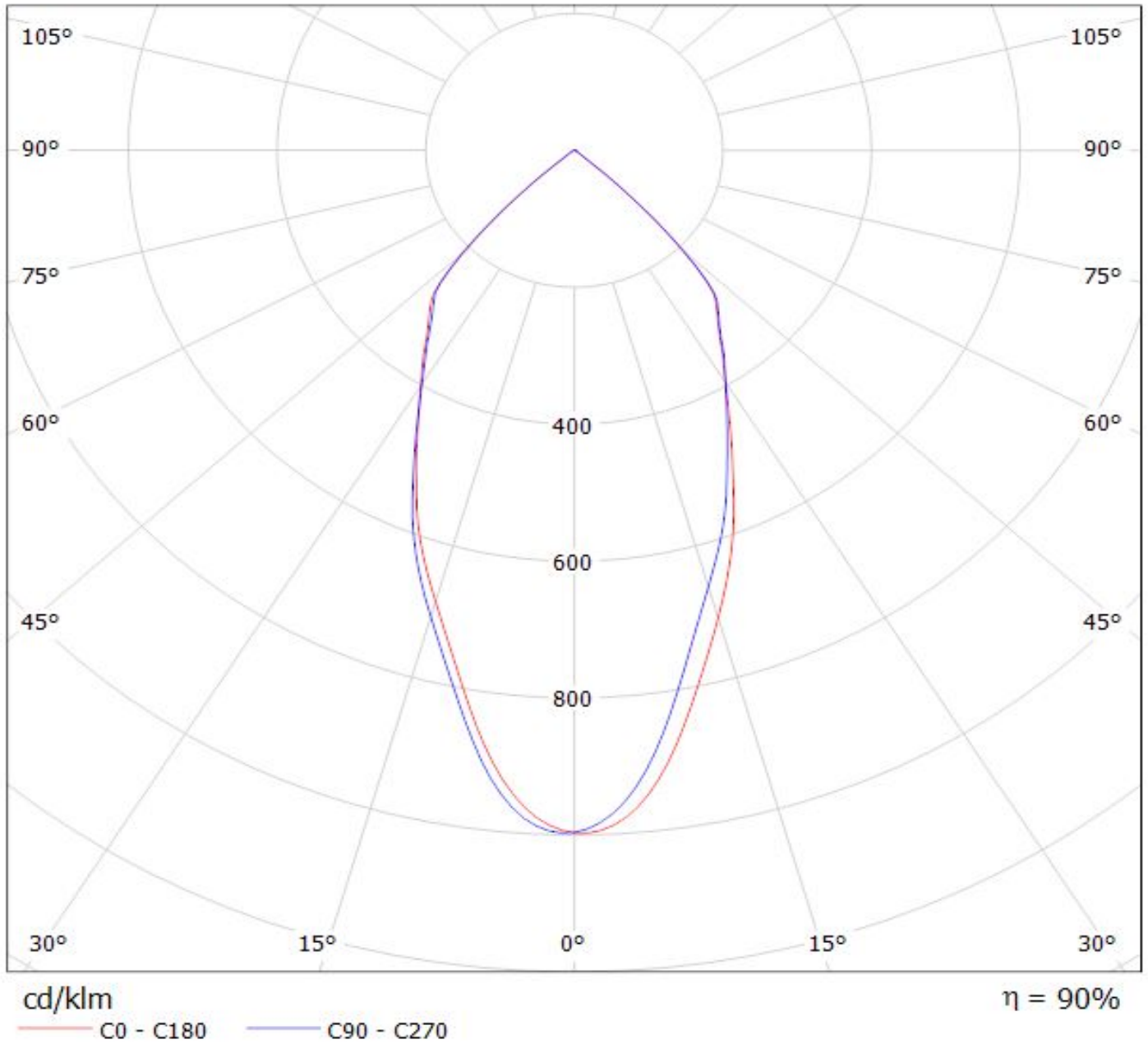

Luminaire: LEDiL Oy F13402_ANGELINA-W_(SLM-G5_LES-19)_ (Z50_Optic_Clip)
Lamps: 1 x Fortimo_SLM-G5_LES-19_1397.58lm@250mA_P=8.0385W_I=0.250A

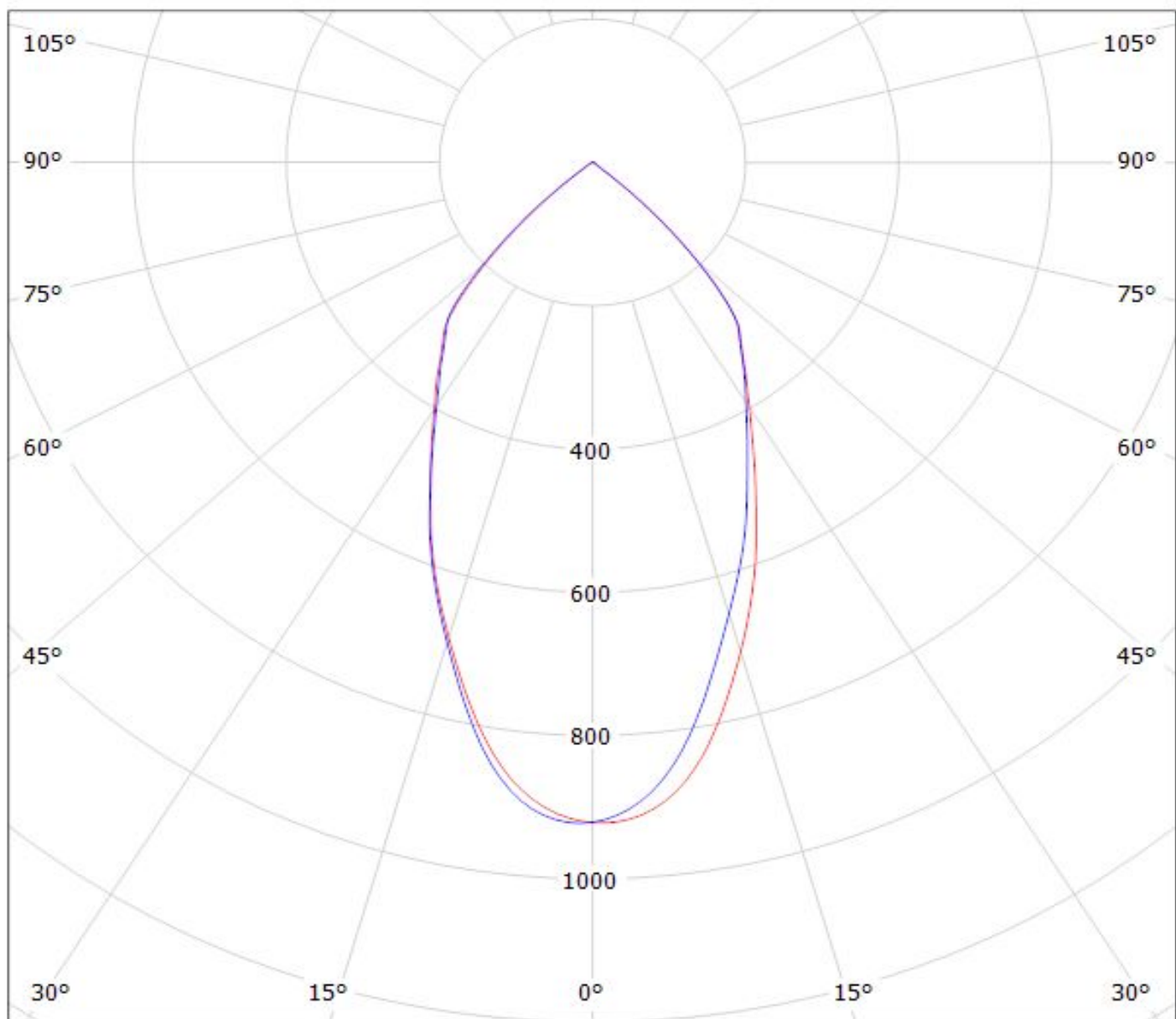

cd/klm

— C0 - C180 — C90 - C270

$\eta = 89\%$

Luminaire: LEDiL Oy F13402_ANGELINA-W_(SLM-G5_LES-13)_ (Z50-Optic-Clip)
Lamps: 1 x Fortimo_SLM-G5_LES-13_1300.47lm@250mA_P=8.4010W_I=0.250A

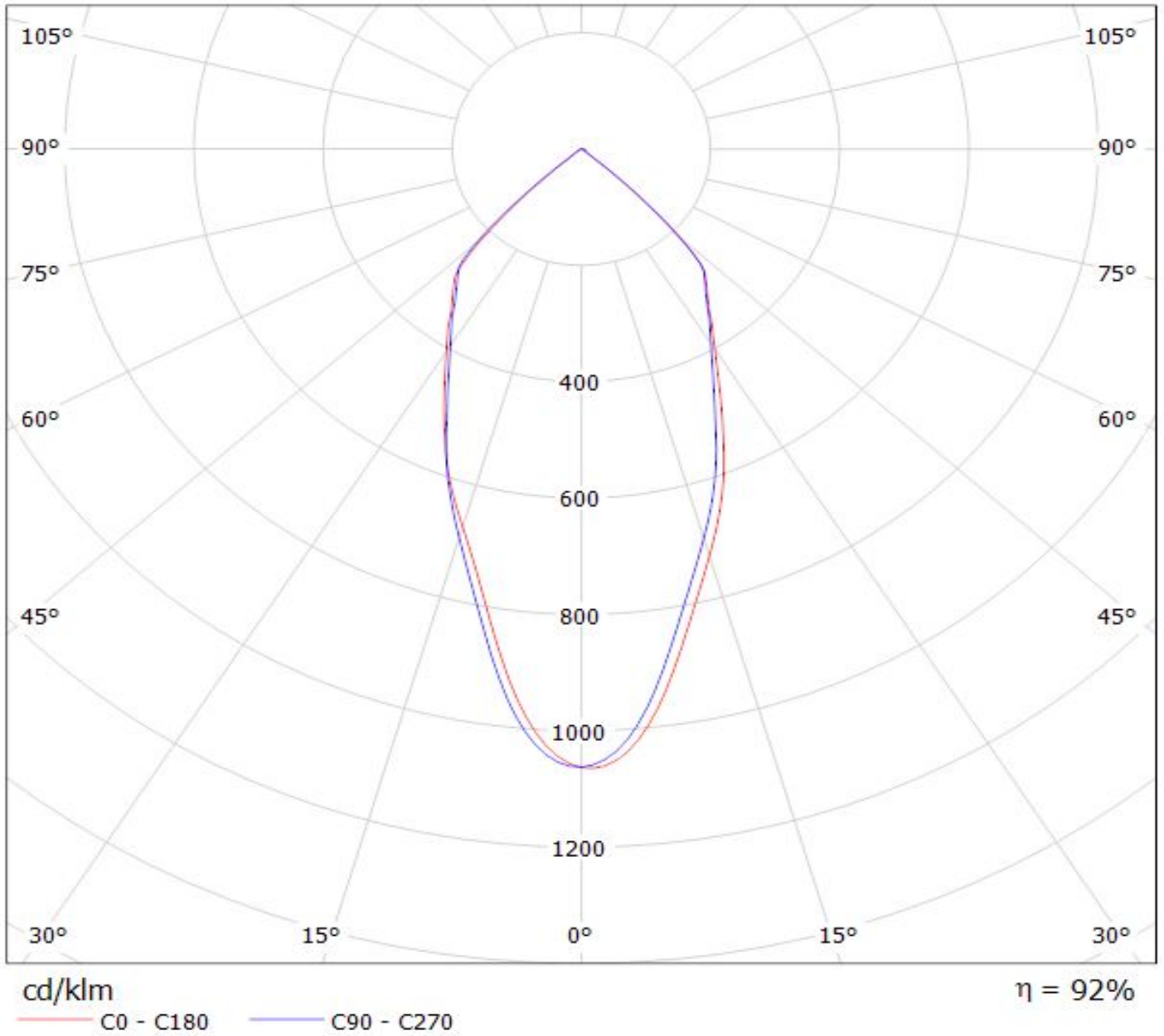

Luminaire: LEDiL Oy F13402_ANGELINA-W_(COB-LC026B) Eff.92.4%

Lamps: 1 x SAMSUNG_COB-LC026B_(SPHWWTHDNC25YHV52F)_1136.23lm@250mA_P=8.23191W_I=249.8mA

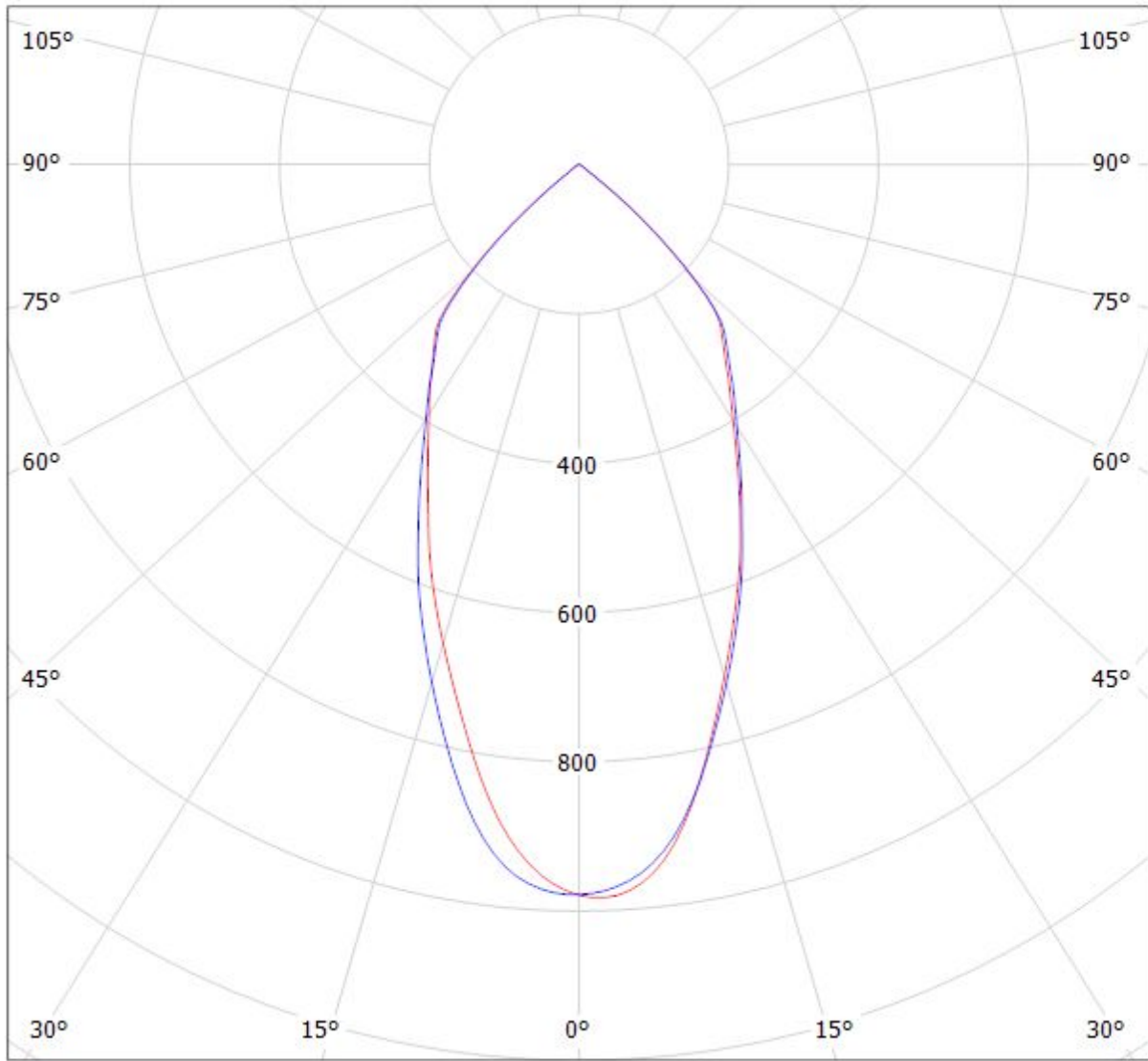

cd/klm

— C0 - C180 — C90 - C270

$\eta = 92\%$

Luminaire: Ledil F13402_ANGELINA-W_(LC040C+TE)

Lamps: 1 x Samsung_LC040C+_2213382-2+_2213194-1_1194.16lm@250mA_CCT=4000K_P=8.137W

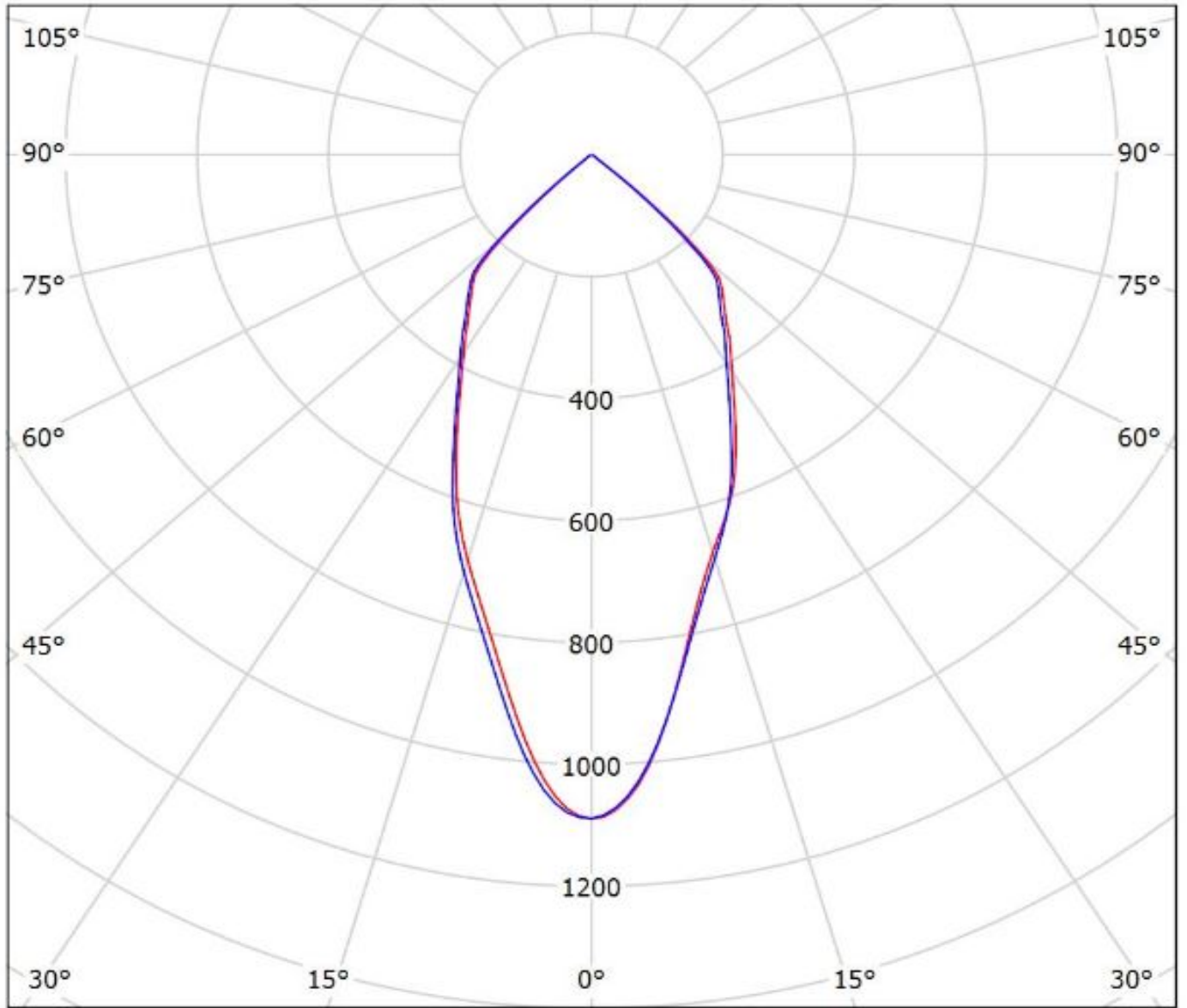

cd/klm

— C0 - C180

— C90 - C270

$\eta = 90\%$

Luminaire: Ledil F13402_ANGELINA-W_(MJT_30W_Les14,5)_TE

Lamps: 1 x Seoul_MJT_30W_Les14,5mm_(SAWx1566A)_+TE_2213254-2_+_TE_2213194-1_1328.6lm@250mA_P=8.24025W_I=0.25A

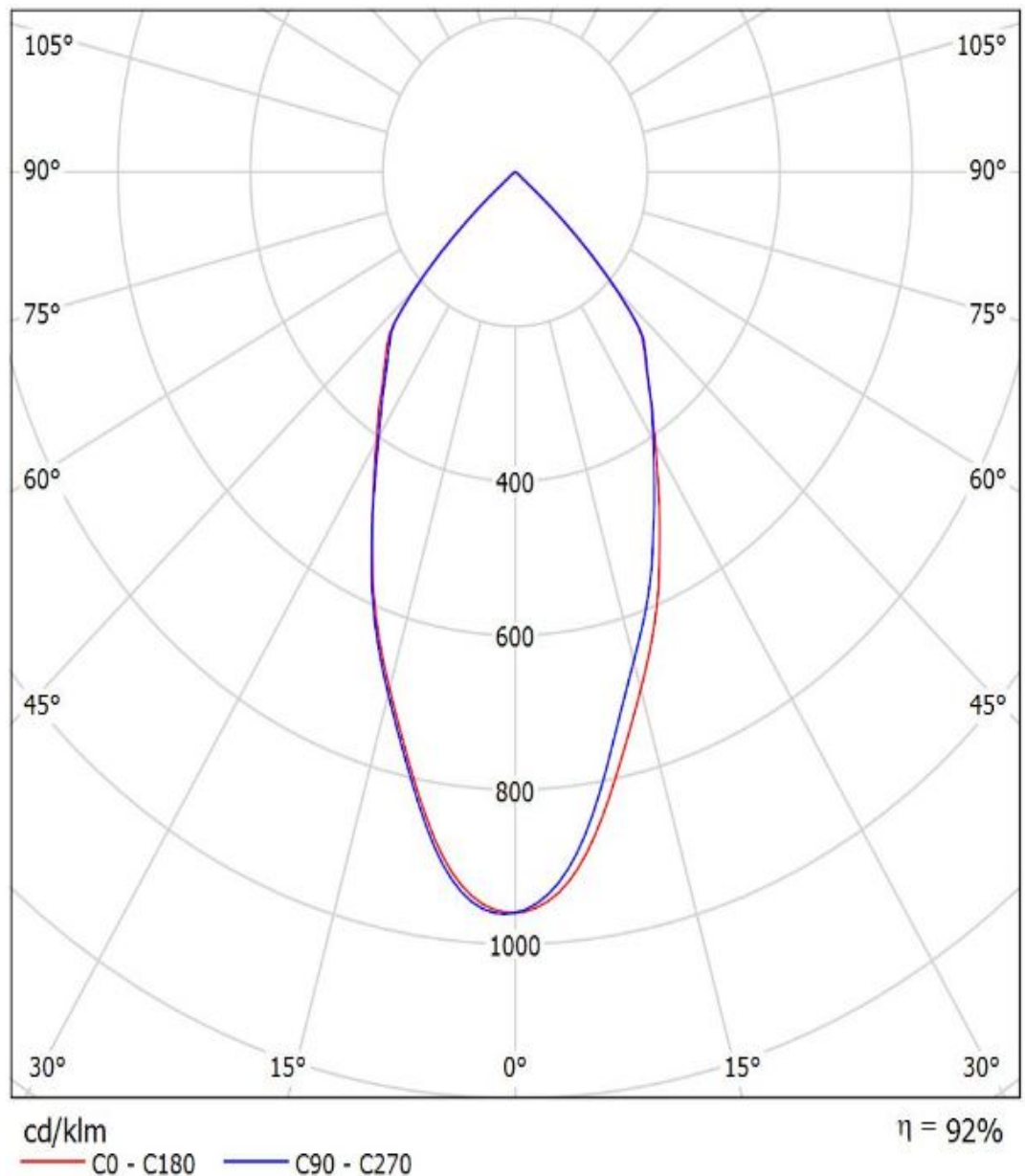

Luminaire: LEDiL Oy F13402_ANGELINA-W_(MegaZenigata) Eff.92.3%
Lamps: 1 x MegaZenigata_GW6DME (518.495lm@100mA)

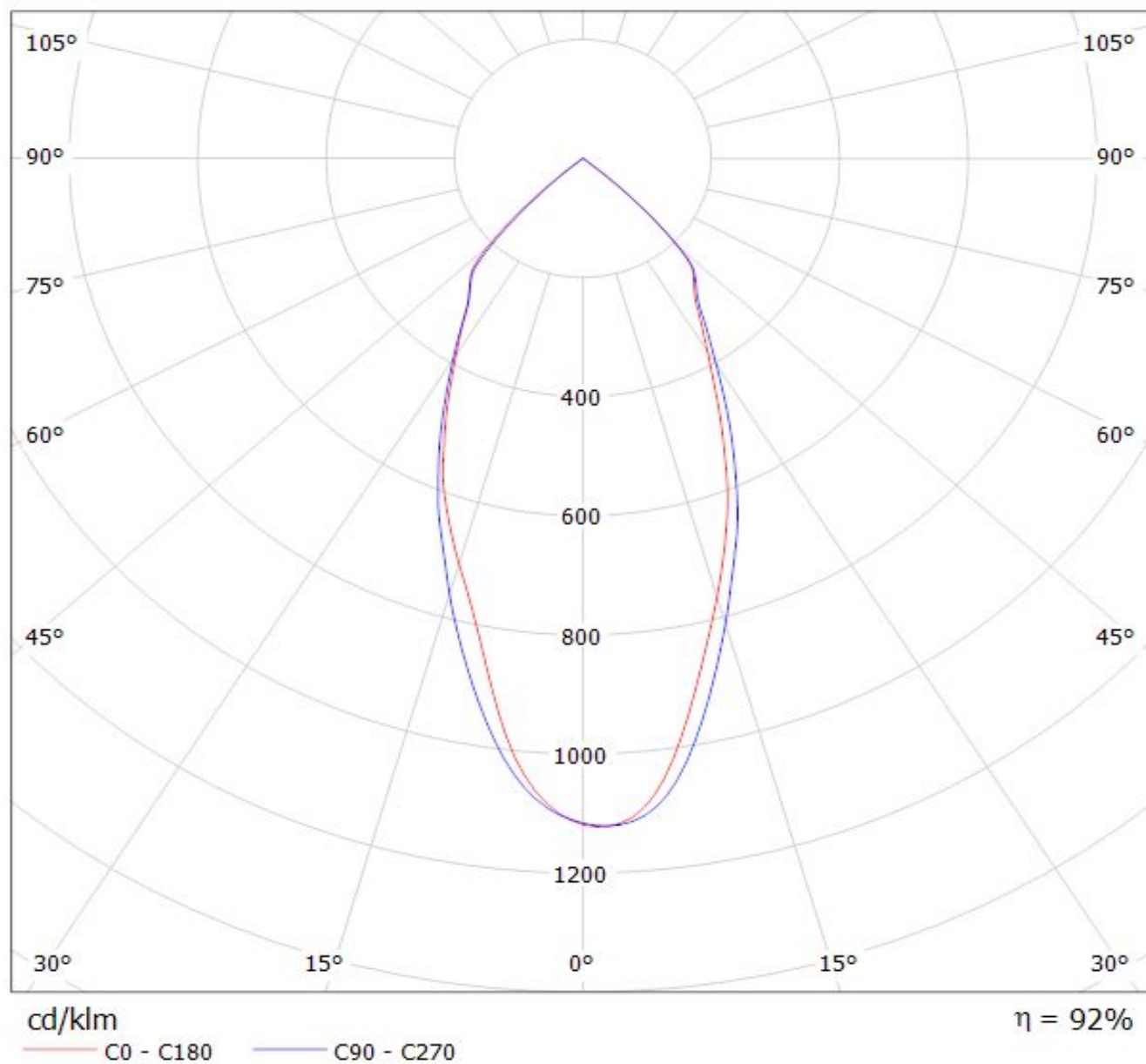

Luminaire: LEDiL Oy F13402_ANGELINA-W_(MEGAZENIGATA) Eff.93.0%
Lamps: 1 x SHARP_MEGAZENIGATA_(GW6DME30NFC)_1238.26lm@250mA_CCT=3000K_P=11.1211W_I=249.8mA

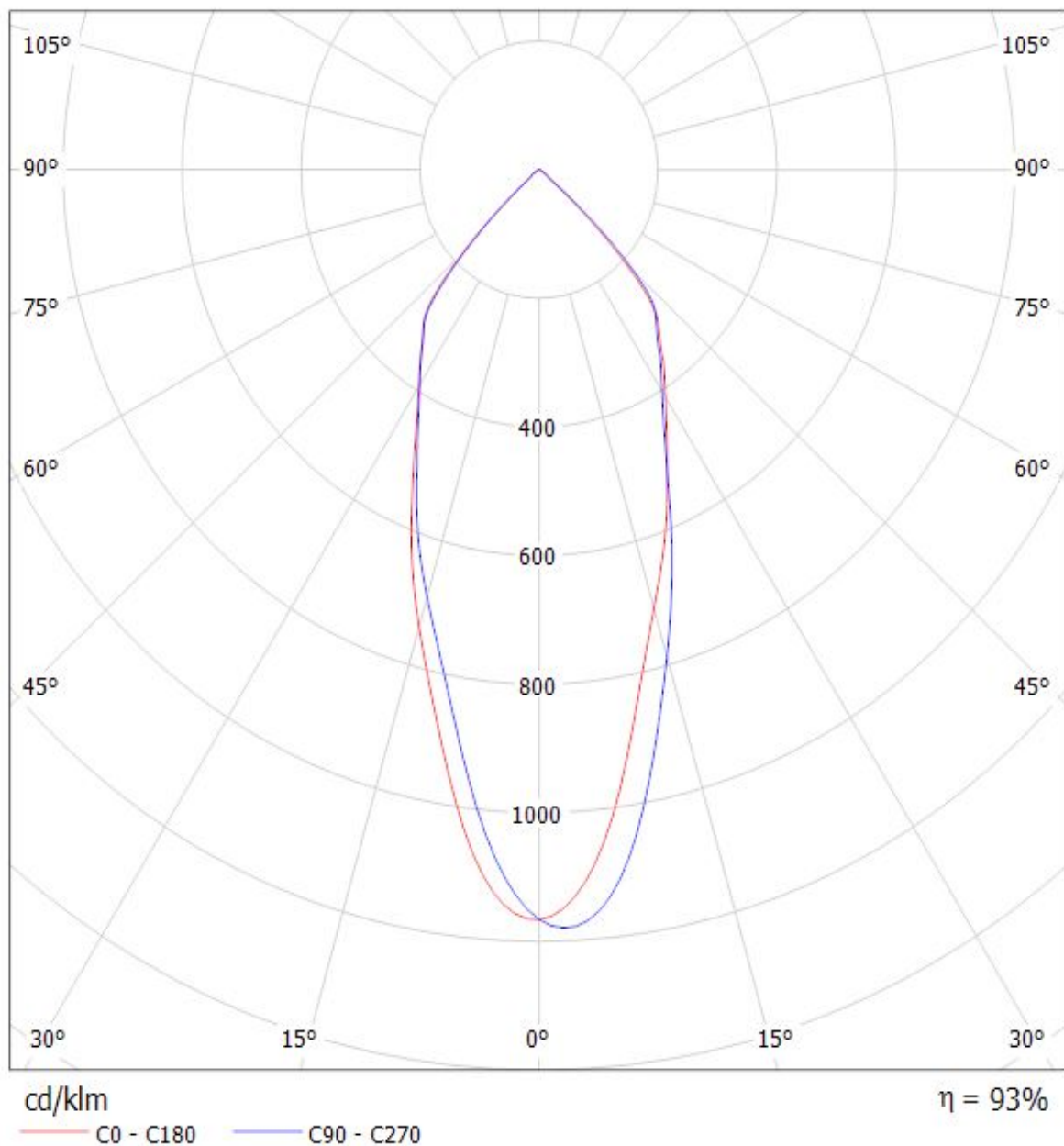

Luminaire: LEDiL Oy F13402_ANGELINA-W_(STARK_SLE_G2_LES19) Eff.91.5%
Lamps: 1 x TRIDONIC STARK SLE G2 LES19 830 CLA 964.643lm@250mA CCT=3000K P=8W I=250mA

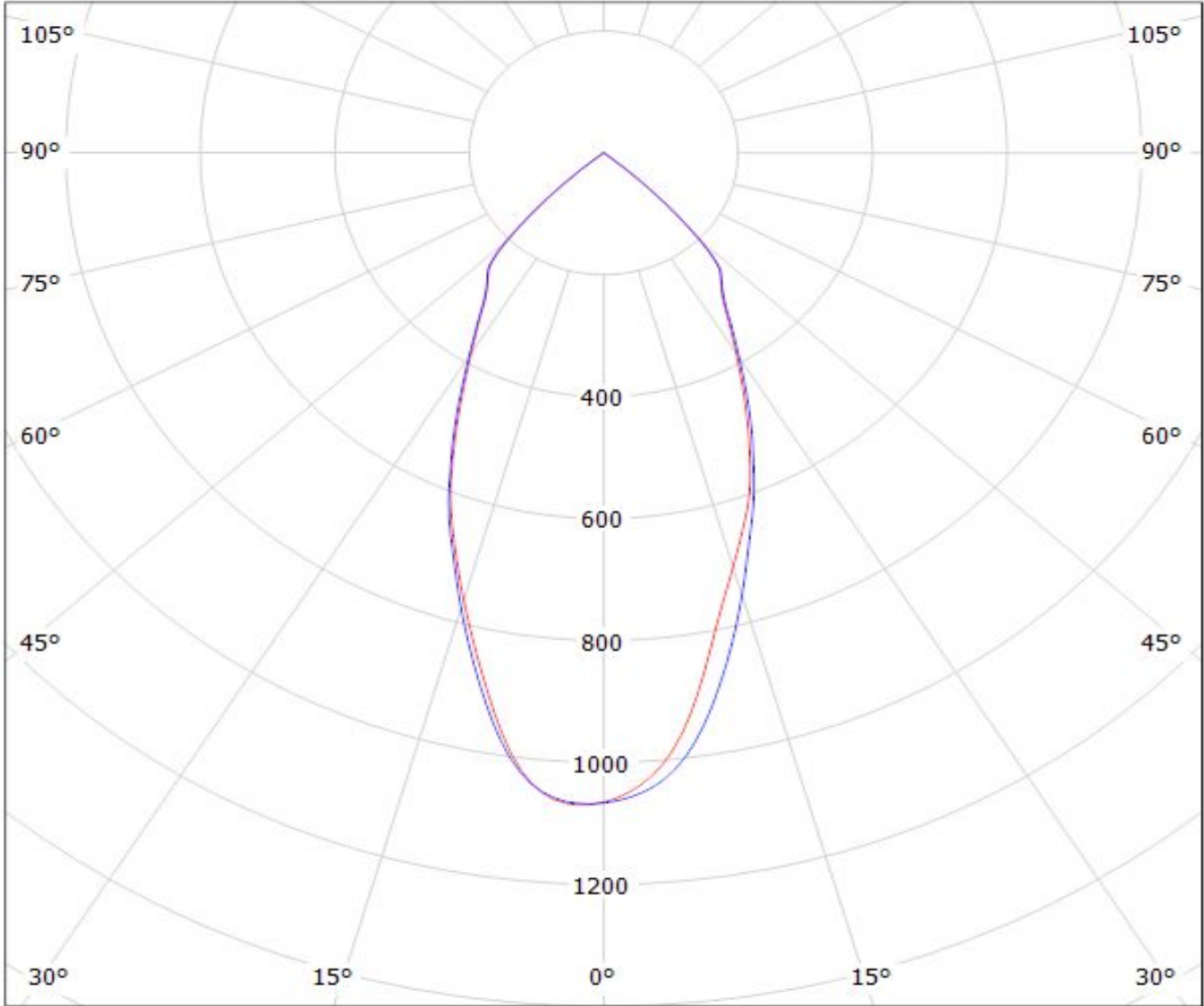

cd/klm

— C0 - C180 — C90 - C270

$\eta = 91\%$

Luminaire: LEDiL Oy F13402_ANGELINA-W_(STARK_SLE_G2_LES23) Eff.90.2%

Lamps: 1 x TRIDONIC STARK SLE G2 LES23 830 CLA 982.73lm@250mA CCT=3000K P=8W I=250mA

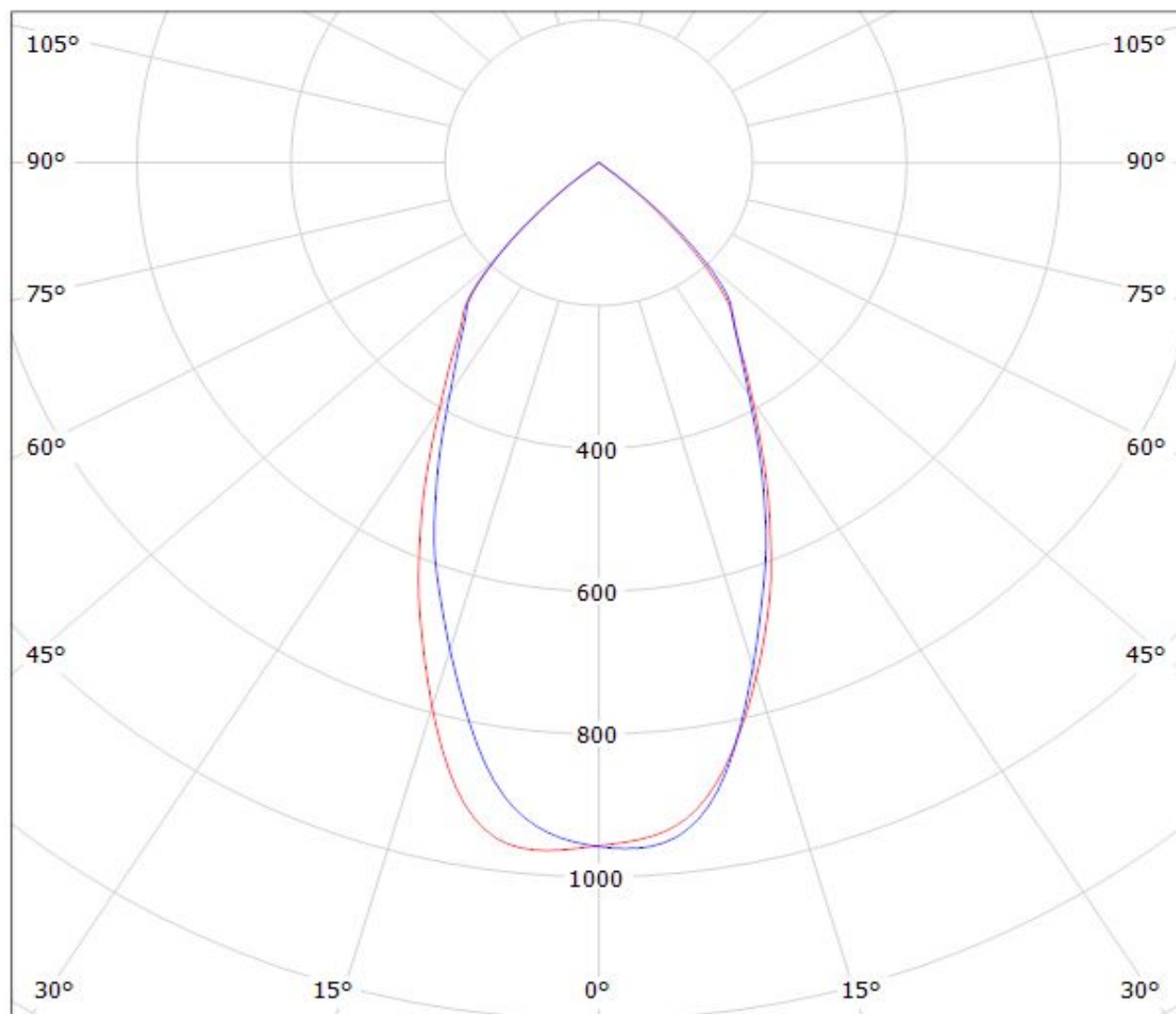

cd/klm

— C0 - C180

— C90 - C270

$\eta = 90\%$

Luminaire: LEDiL Oy F13402_ANGELINA-W_(STARK_SLE_G2_LES26) Eff.89.0%

Lamps: 1 x TRIDONIC STARK SLE G2 LES26 830 CLA 1095.88lm@250mA CCT=3000K P=8W I=250mA

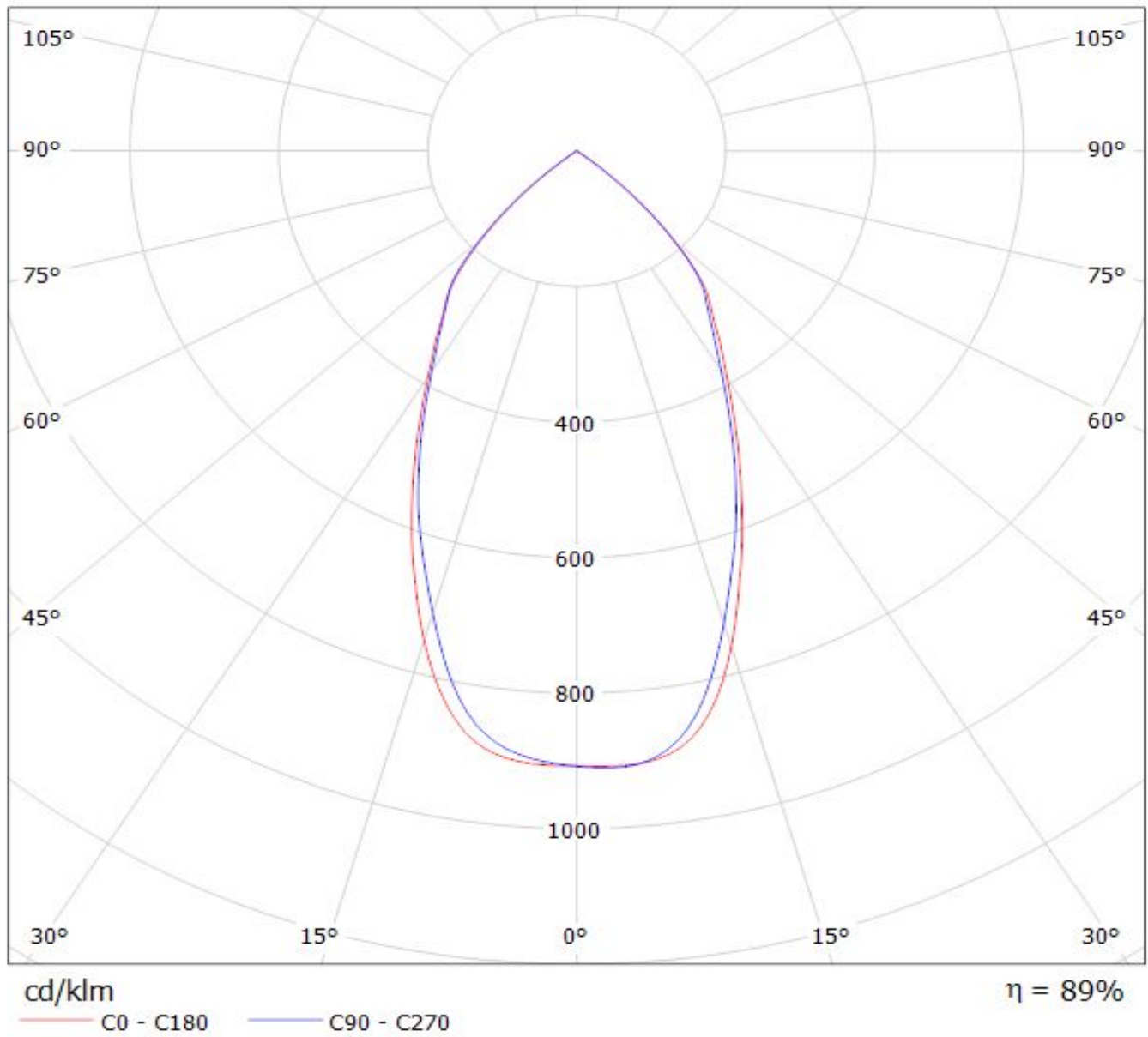

Luminaire: LEDiL Oy F13402_ANGELINA-W_(SLE_G3_LES19) Eff.92.2%

Lamps: 1 x TRIDONIC_STARK_SLE_G3_LES19_(STARK-SLE-G3-LES19-2000-840-CLA)_1058.33lm@250mA_P=8.32833W_I=249.8mA

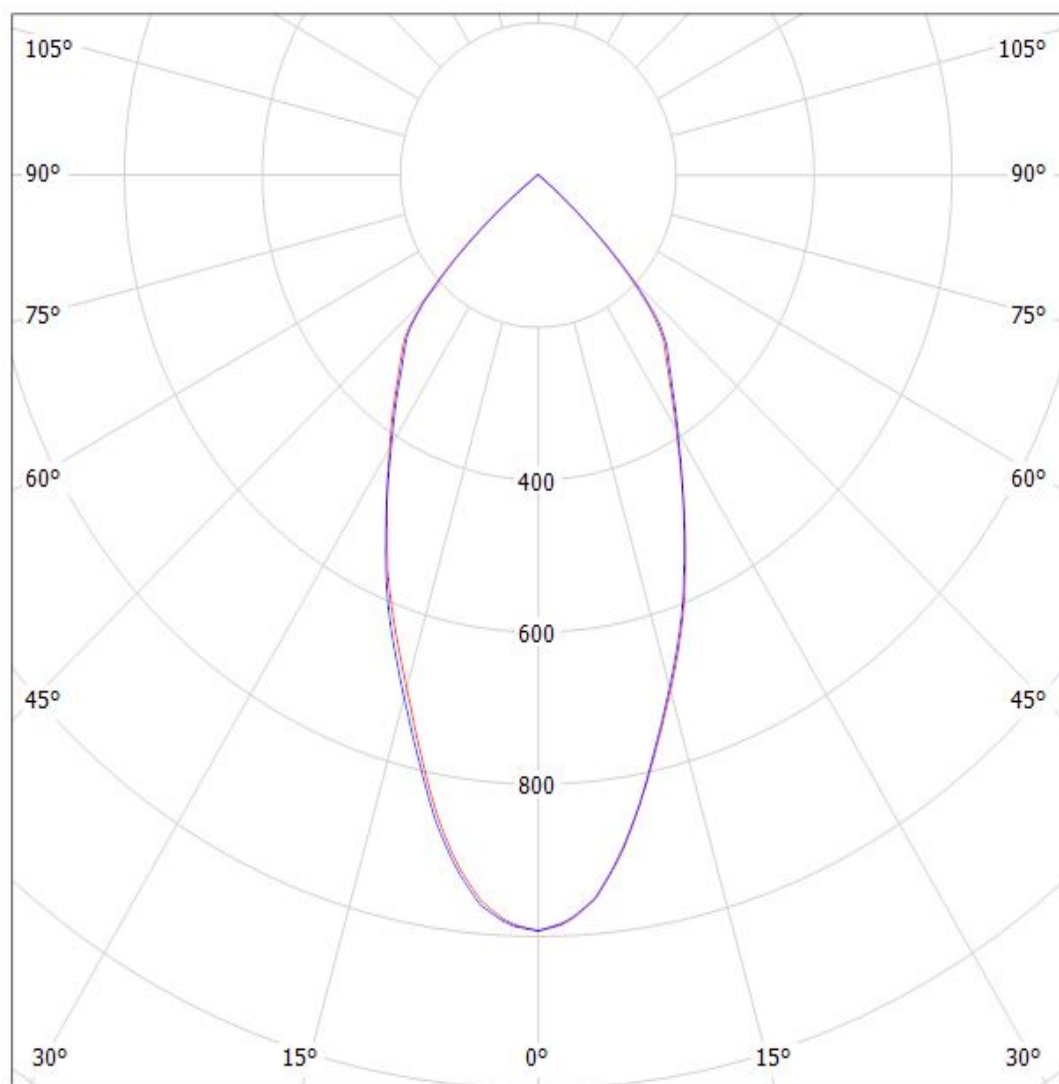

cd/klm

— C0 - C180

— C90 - C270

$\eta = 92\%$

Luminaire: LEDiL Oy F13402_ANGELINA-W_(SLE_G3_LES23) Eff.90.3%

Lamps: 1 x TRIDONIC_STARK_SLE_G3_LES23_(STARK-SLE-PURE_G3-23-3000-930-SEL)_813.196lm@250mA_CCT=3000K_P=8.20018W_I=249.8mA

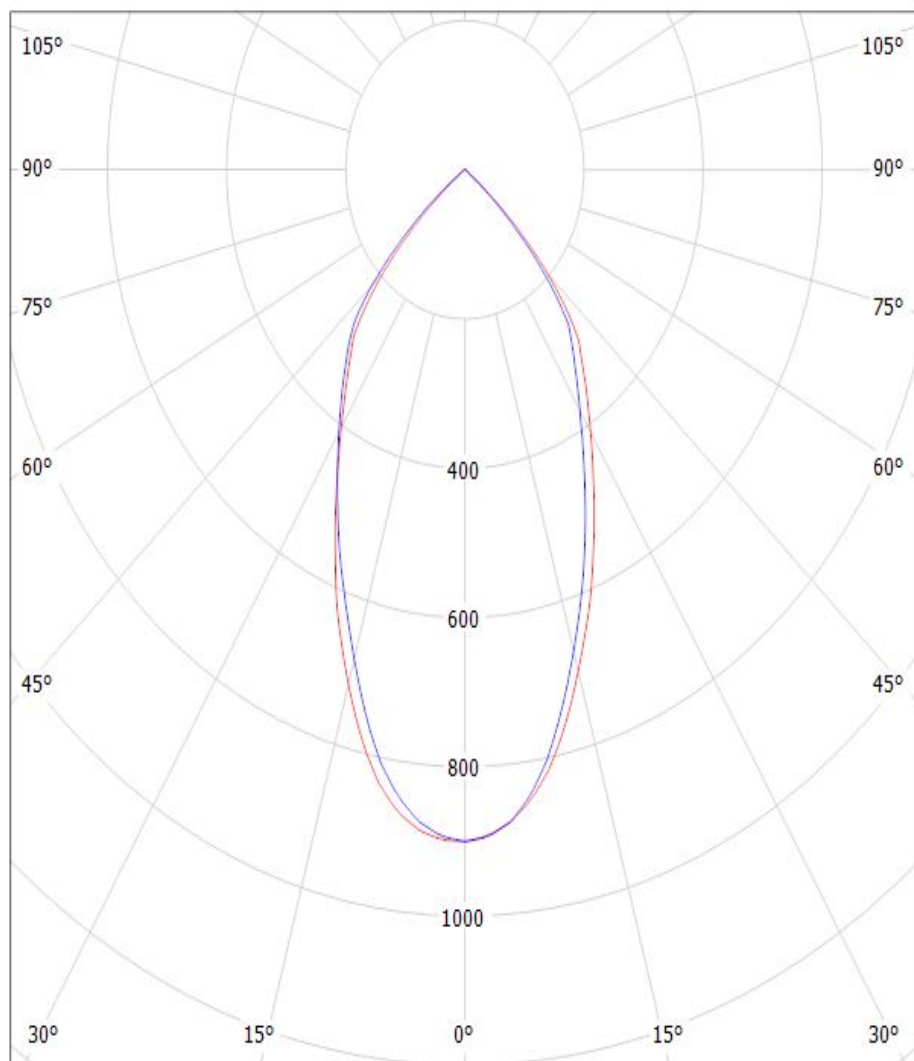

cd/klm

— C0 - C180 — C90 - C270

$\eta = 90\%$

Luminaire: LEDiL Oy F13402_ANGELINA-W_(SLE_G4_LES23)

Lamps: 1 x Tridonic_SLE_G4_LES23_1354.57lm@250mA_P=8.18744W_I=0.2498A

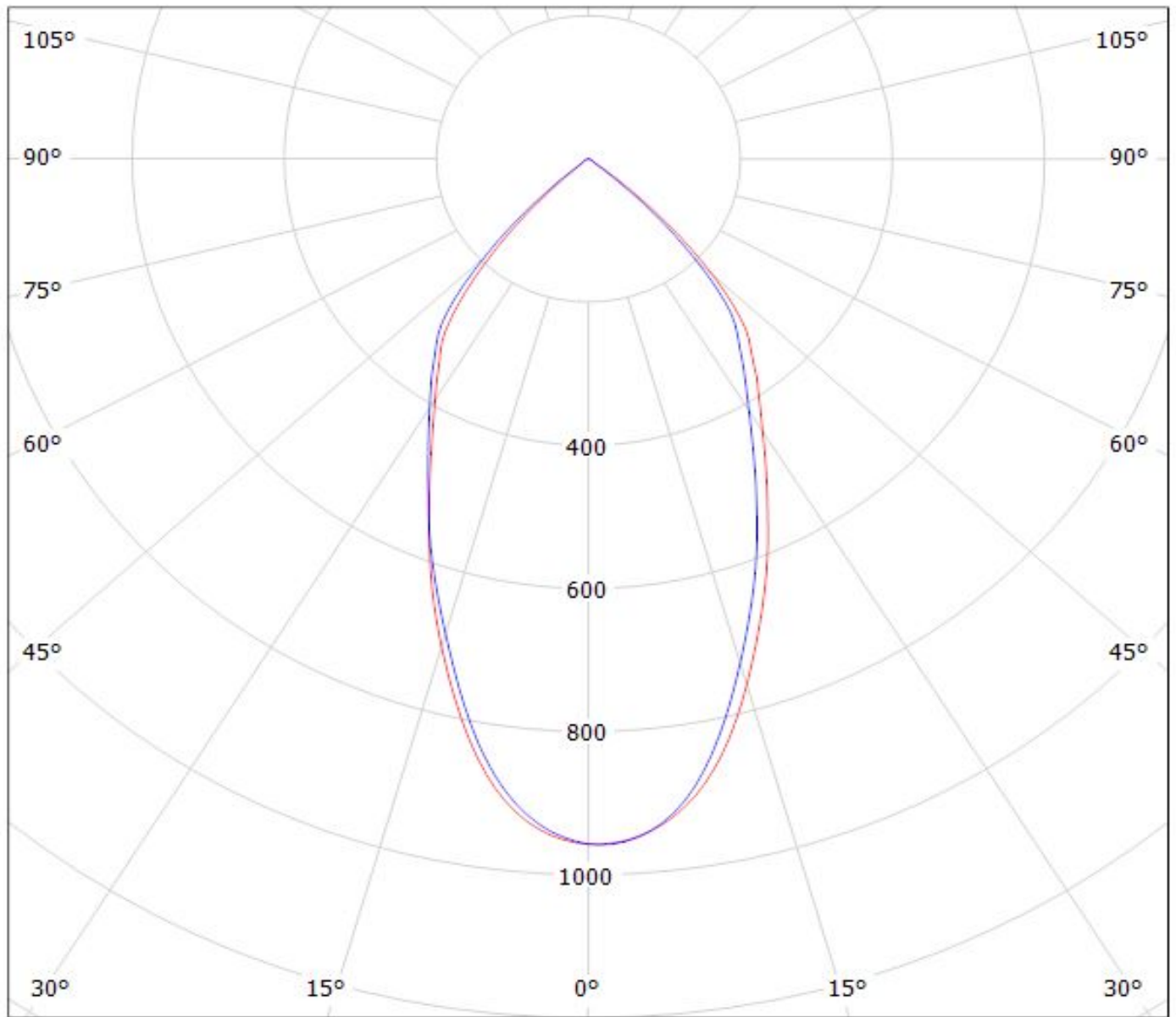

cd/klm

$\eta = 93\%$

— C0 - C180

— C90 - C270

Luminaire: LEDiL Oy F13402_ANGELINA-W_(SLE GEN4 LES19)
Lamps: 1 x SLE GEN4 LES19_1226.28lm@250mA_P=8.21367W_I=0.2498A

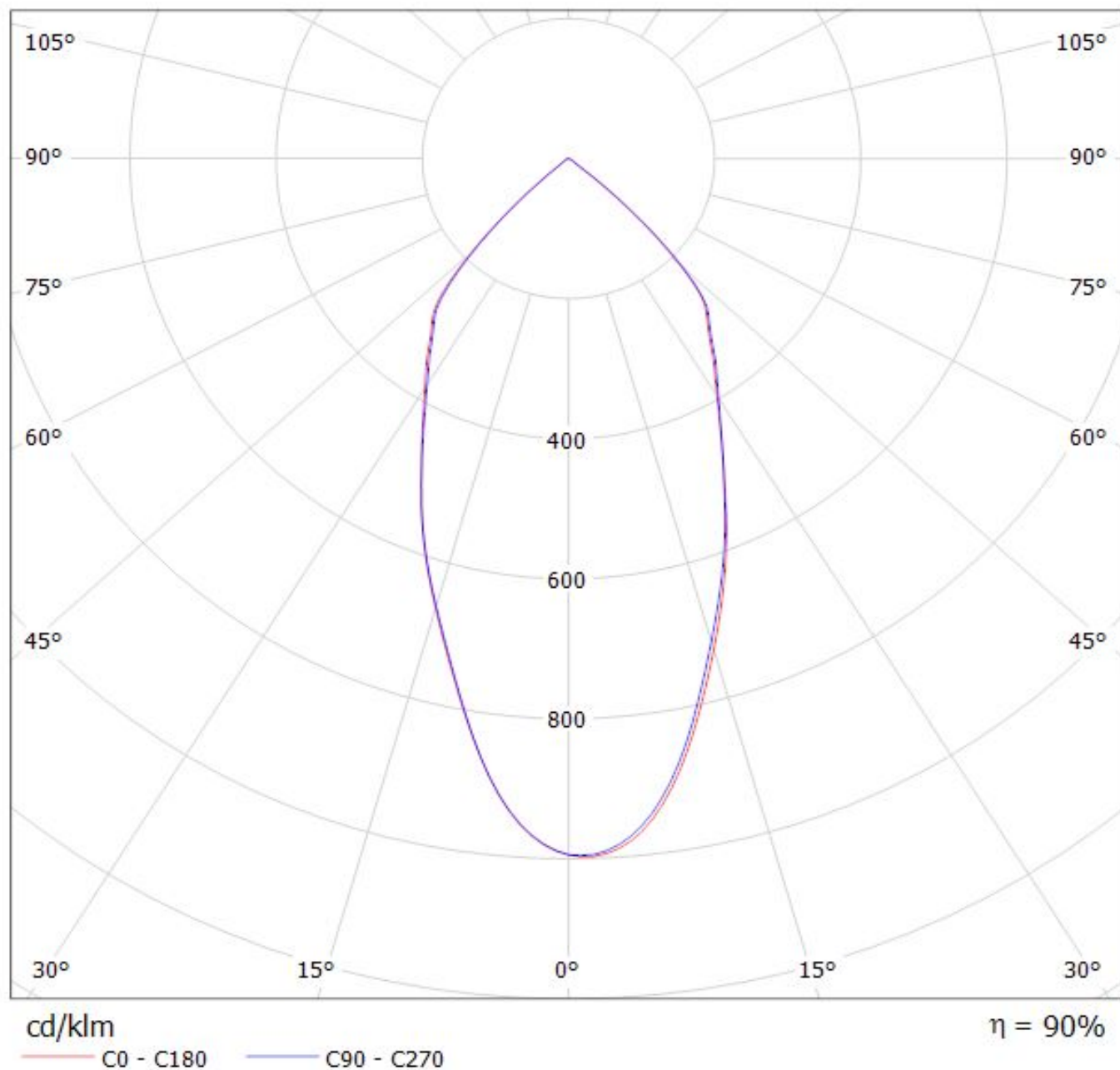

Luminaire: LEDiL Oy F13402_ANGELINA-W_(SLE-G5_LES-15)

Lamps: 1 x Tridonic_SLE-G5_LES-15_1247.09lm@250mA_P=8.6730W_I=0.250A

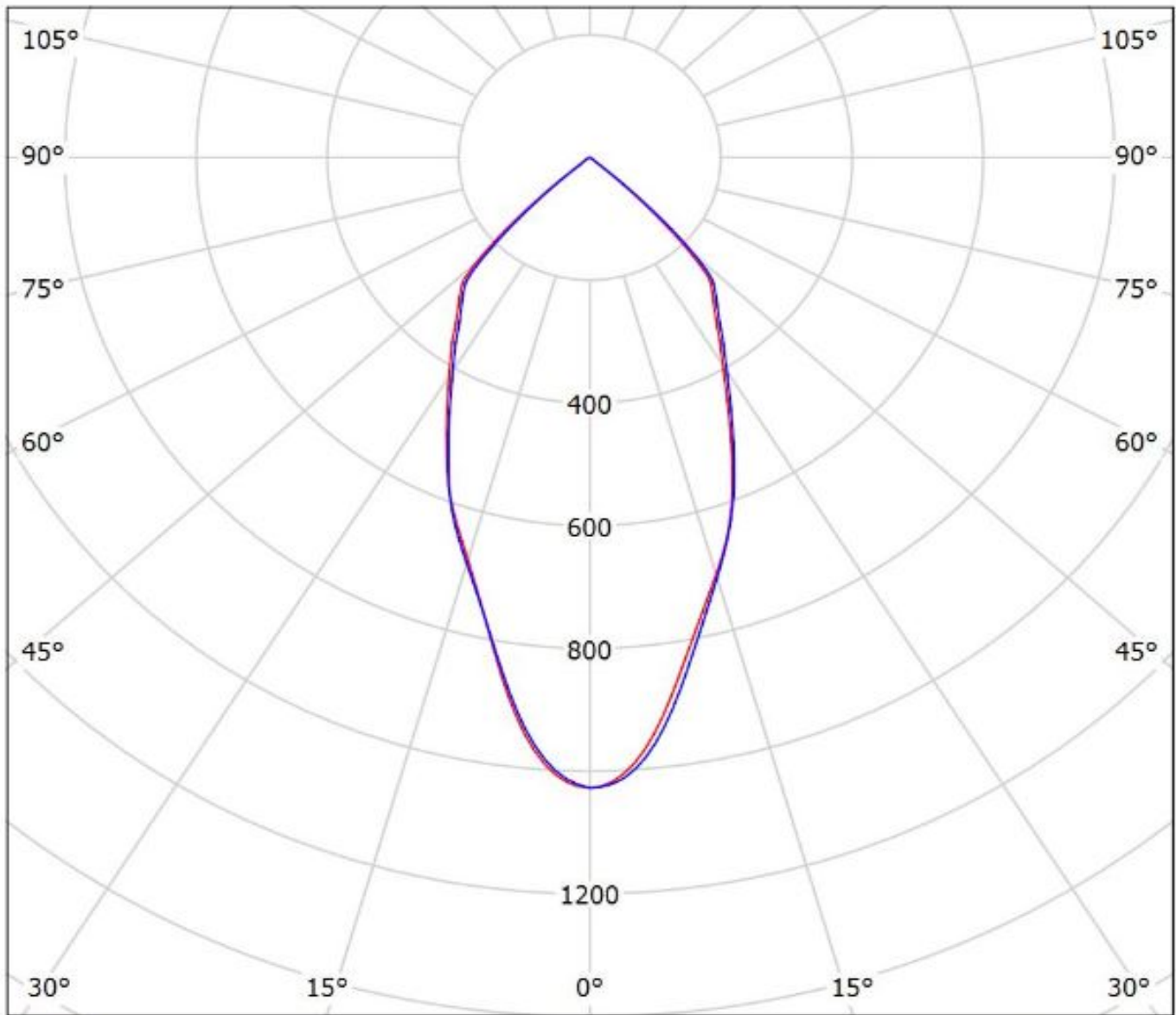

cd/klm

— C0 - C180

— C90 - C270

$\eta = 92\%$

Luminaire: LEDiL Oy F13402_ANGELINA-W_(SLE-G5_LES-19)
Lamps: 1 x Tridonic_SLE-G5_LES-19_1287.79lm@250mA_P=8.2274W_I=0.250A

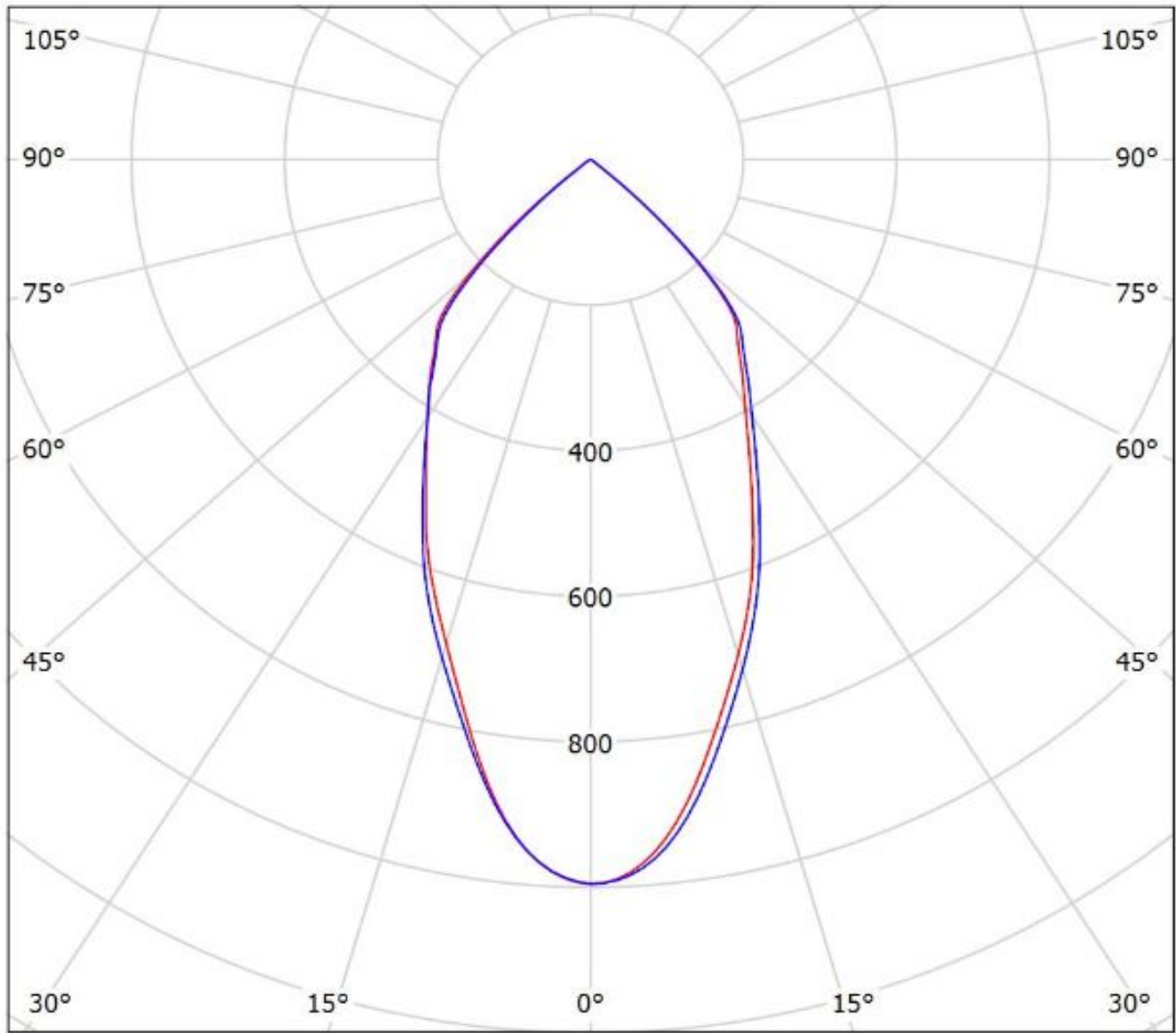

cd/klm

— C0 - C180

— C90 - C270

$\eta = 92\%$

Luminaire: LEDiL Oy F13402_ANGELINA-W_(SLE-G5_LES-23)

Lamps: 1 x Tridonic_SLE-G5_LES-23_1303.96lm@250mA_P=8.1062W_I=0.250A

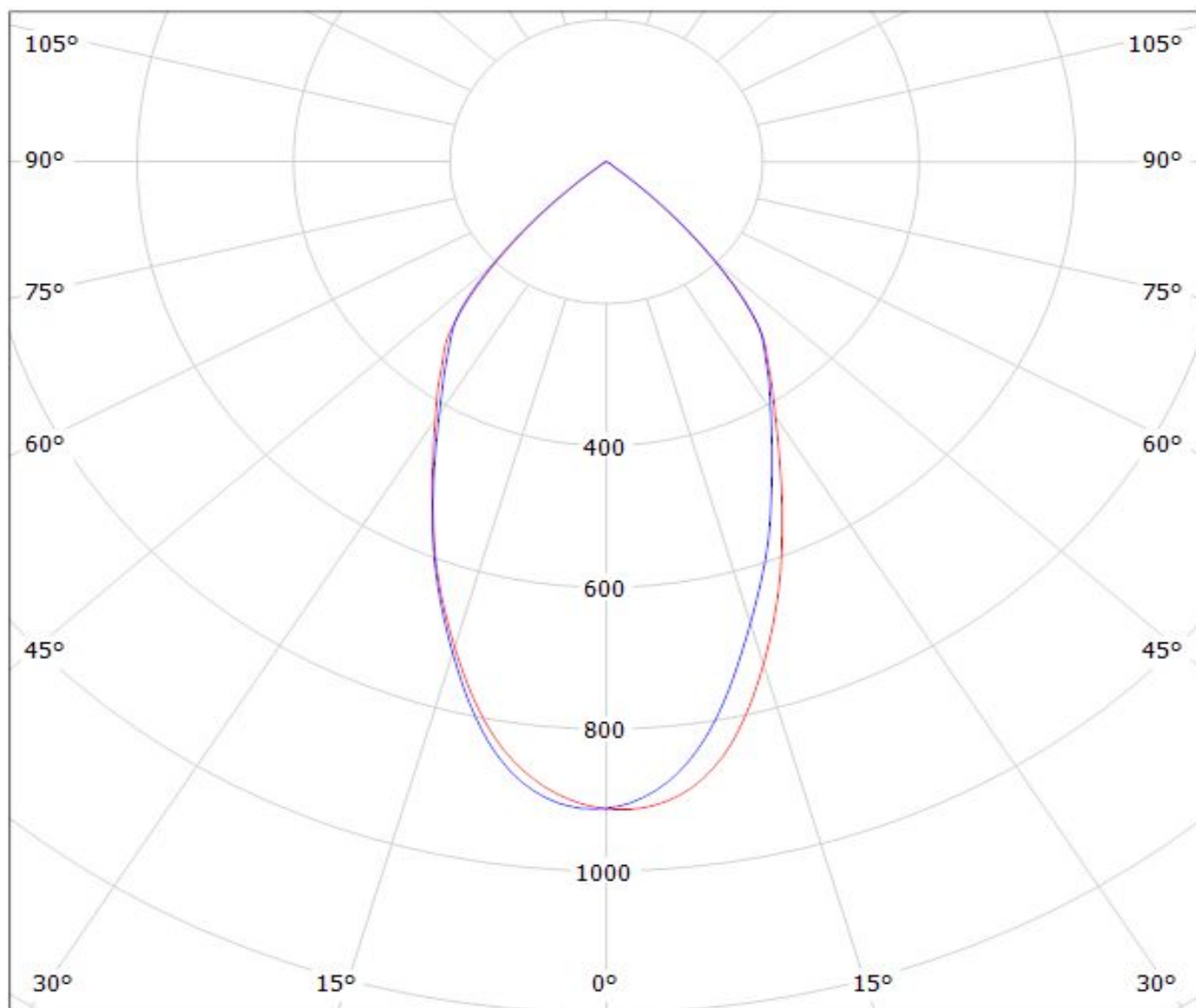

cd/klm

— C0 - C180

— C90 - C270

$\eta = 93\%$

Luminaire: Ledil Oy F13402_ANGELINA-W_(SLE_G6_LES15)_(2213254-2+_2213194-1)_SIMULATED
Lamps: 1 x Tridonic SLE G5 LES15 + Tyco Electronics 2213254-2 + TE 2213194-1 optic clip

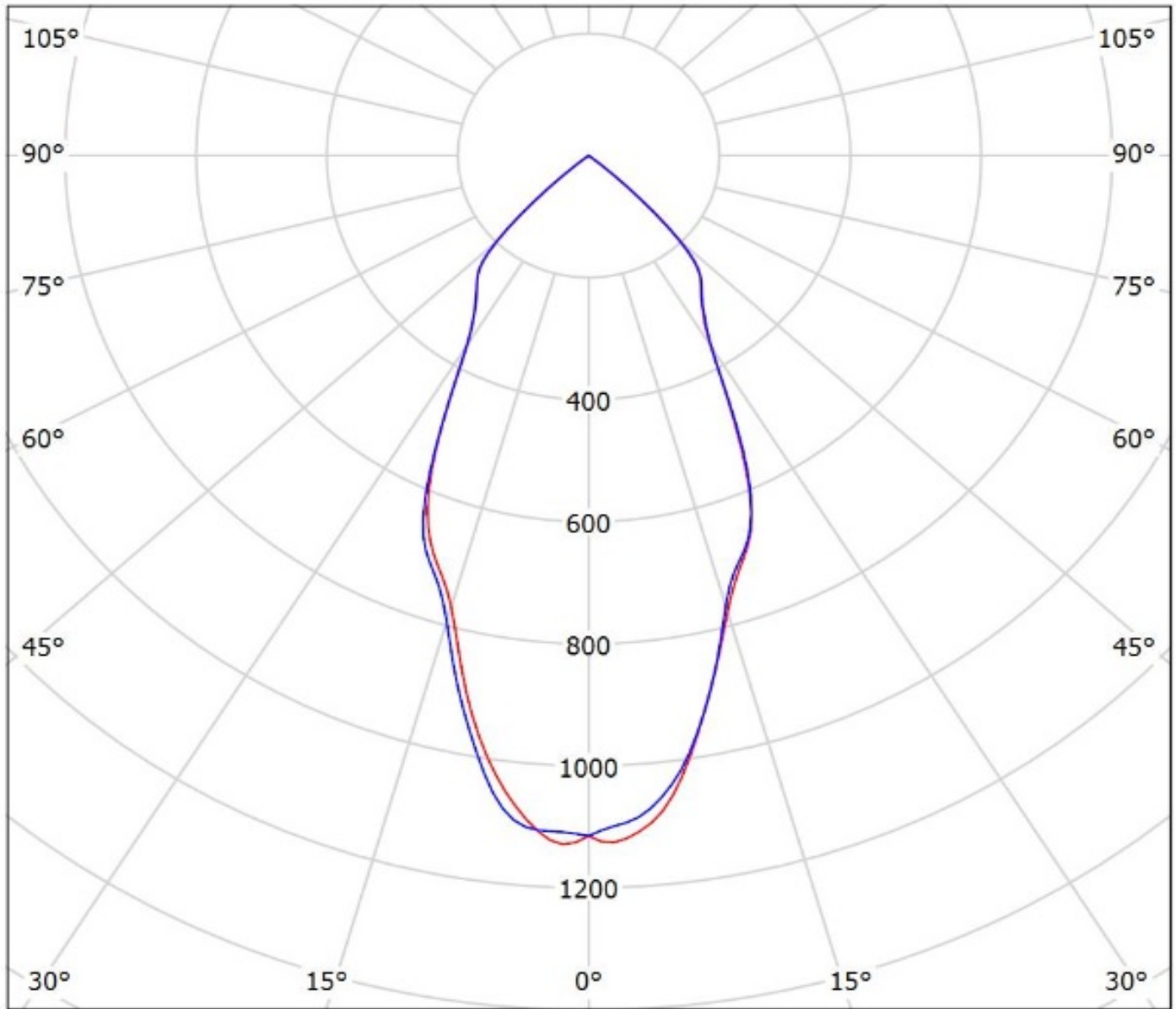

cd/klm
— C0 - C180 — C90 - C270

$\eta = 92\%$

Luminaire: Ledil Oy F13402_ANGELINA-W+_TE_2213254-2+_TE_Z50_Type1_TRIDONIC_SLE_G6_LES17_SIMULATED
Lamps: 1 x TRIDONIC SLE G6 LES17

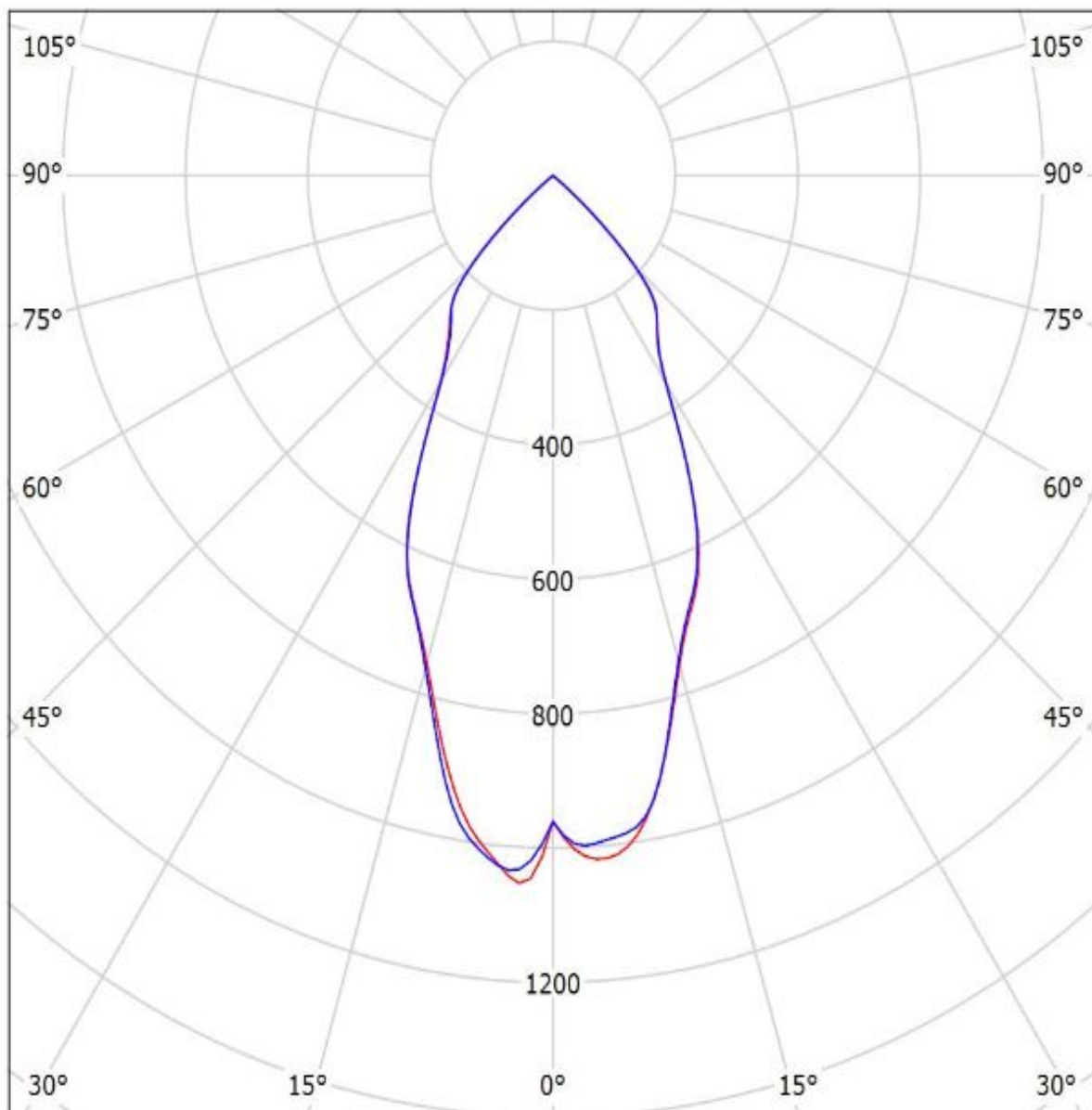

cd/klm

— C0 - C180 — C90 - C270

$\eta = 89\%$

Luminaire: LEDiL Oy F13402_ANGELINA-W_(WU-M-461-827)

Lamps: 1 x Vossloh_WU-M-461-827_773.276lm@250mA_P=6.27423W_I=249.8mA

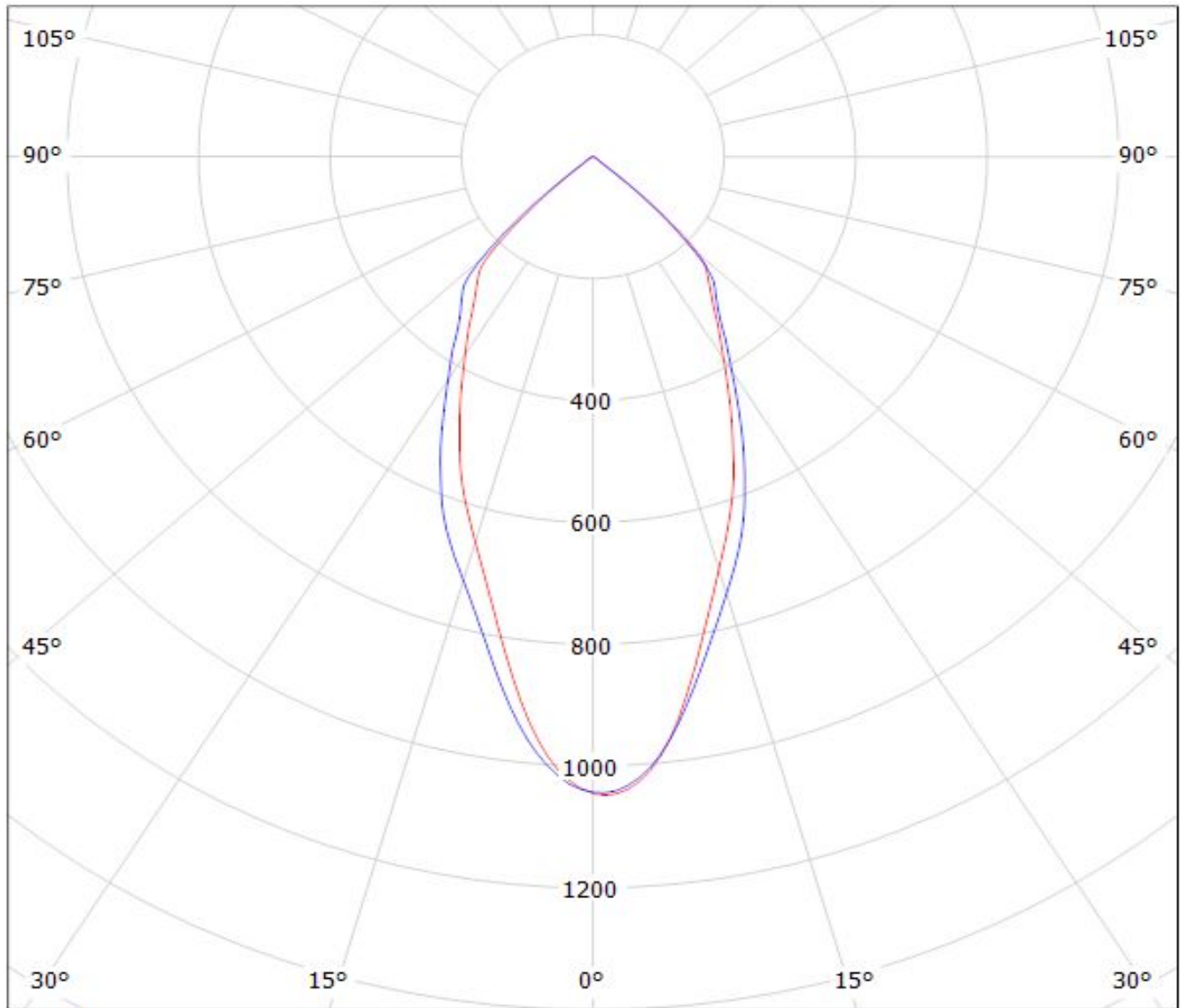

cd/klm

— C0 - C180

— C90 - C270

$\eta = 93\%$

Luminaire: LEDiL Oy F13402_ANGELINA-W_(WU-M-462-827)

Lamps: 1 x Vossloh_WU-M-462-827_1116.7lm@250mA_P=8.9943W_I=249.8mA

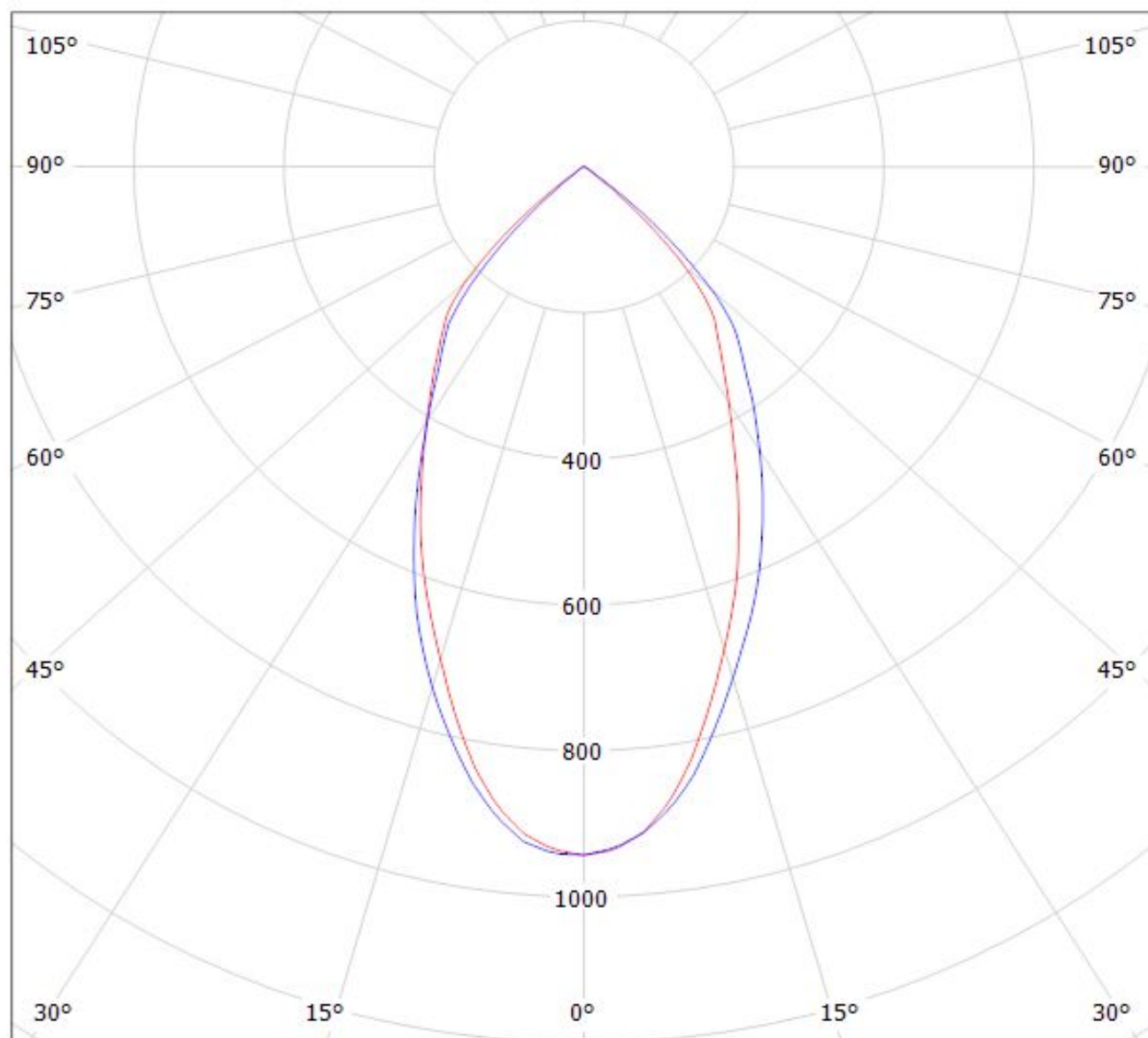

cd/klm

— C0 - C180

— C90 - C270

$\eta = 93\%$

Luminaire: LEDiL Oy F13402_ANGELINA-W_(WU-M-464-827)

Lamps: 1 x Vossloh_WU-M-464-827_1452.93lm@250mA_P=11.6939W_I=249.8mA

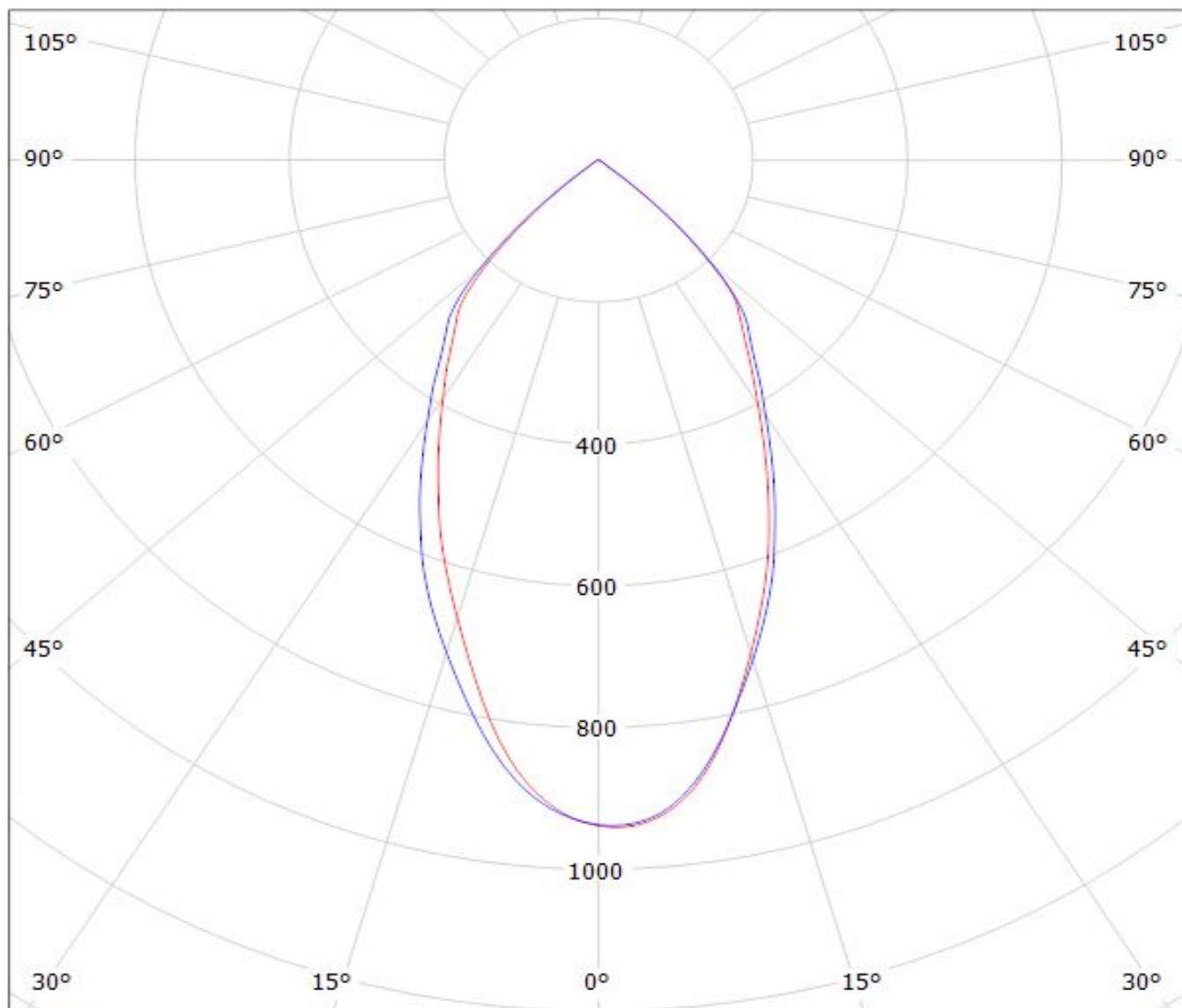

cd/klm

— C0 - C180

— C90 - C270

$\eta = 93\%$

Luminaire: LEDiL Oy F13402_ANGELINA-W_(WU-M-484)

Lamps: 1 x Vossloh_Schwabe-WU-M-484_(WU-M-484-830)_657.125lm@250mA_P=5.59976W_I=249.9mA

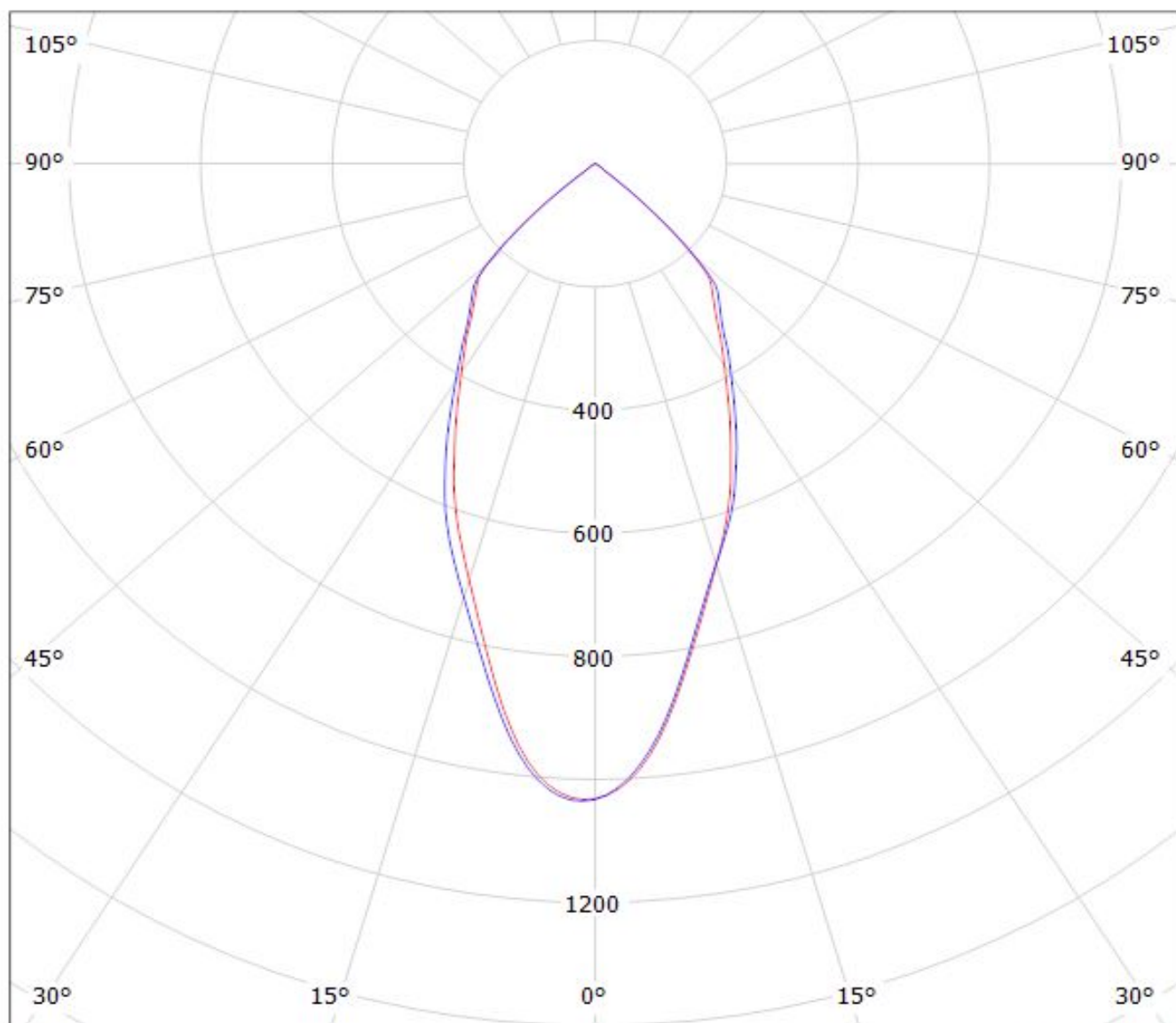

cd/klm

— C0 - C180

— C90 - C270

$\eta = 93\%$

Luminaire: LEDiL Oy F13402_ANGELINA-W_(WU-M-484)

Lamps: 1 x Vossloh_Schwabe-WU-M-485_(WU-M-485-830)_1209.62lm@250mA_P=8.43849W_I=249.8mA

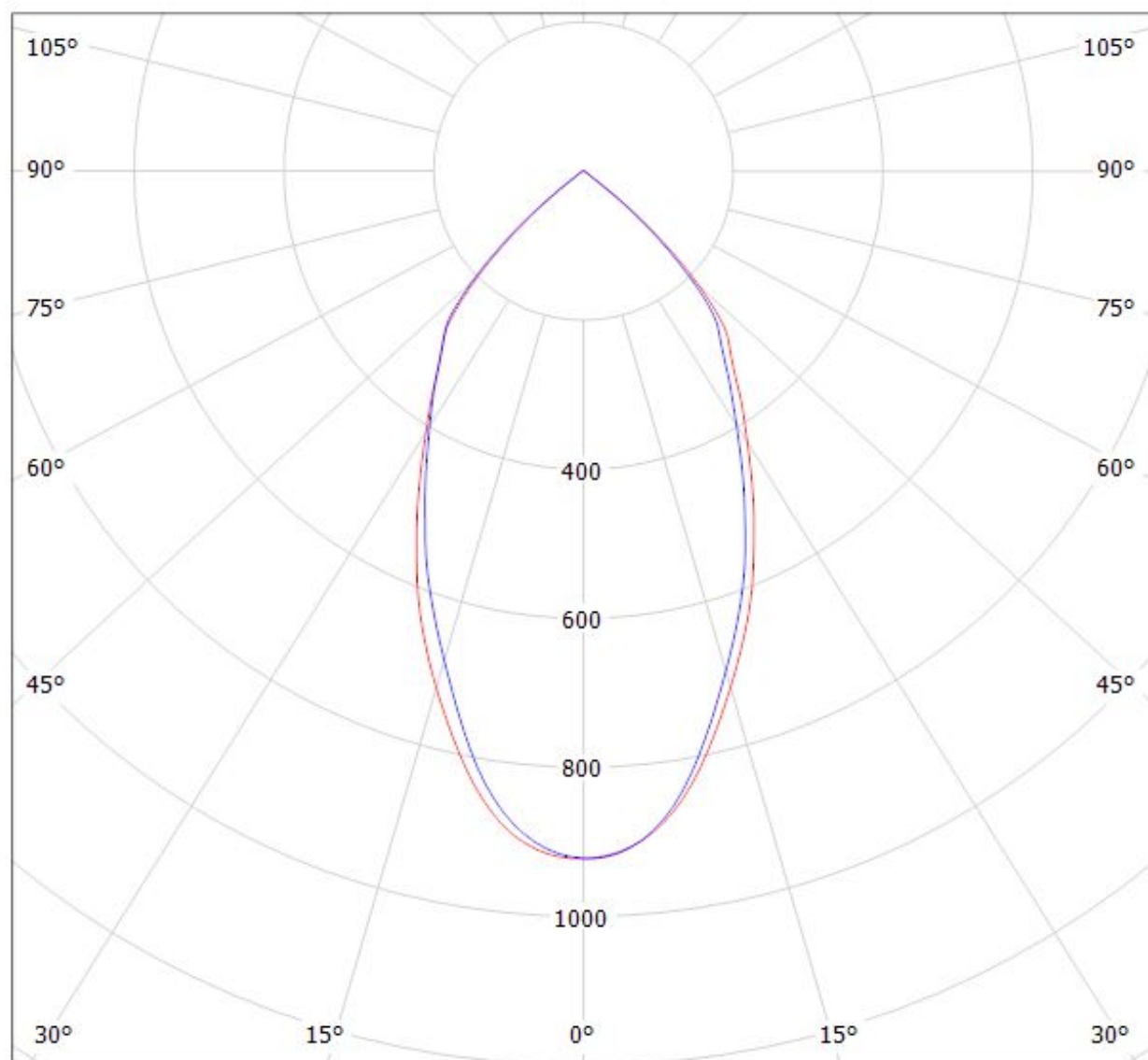

cd/klm

— C0 - C180

— C90 - C270

$\eta = 93\%$

Luminaire: LEDiL Oy F13402_ANGELINA-W_(WU-M-486) Eff.92.5%
Lamps: 1 x Vossloh_Schwabe-WU-M-486_(WU-M-486-830)
_1474.55lm@250mA_P=10.4456W_I=249.8mA

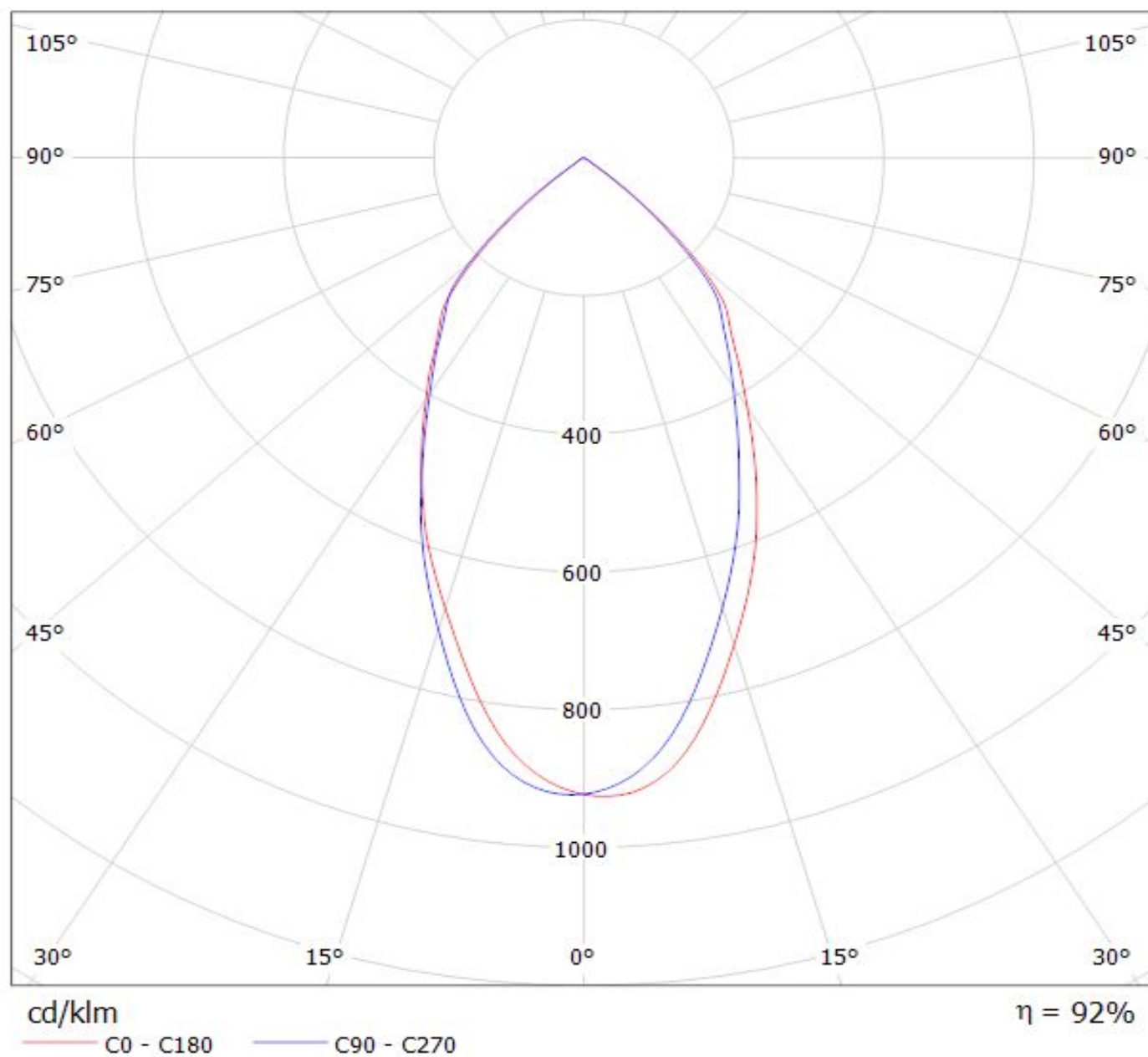

NOTE: The typical divergence will be changed by different color, chip size and chip position tolerance. The typical total divergence is the full angle measured where the luminous intensity is half of the peak value.

GENERAL INFORMATION

- Product series especially designed & optimized for series of LEDs.
- Special care taken to make light distribution as uniform as possible.

Note! Due to use of high power COB's with this product, special attention to proper thermal design is highly recommended. LEDiL has no liability for direct, indirect or consecutive damages arising from the LEDiL products being used outside of the recommended temperature range.