

**SPECIFICATIONS:**

**ELECTRICAL:**

INSULATOR RESISTANCE: 5,000 MegOHMS Min.  
 DIELECTRIC WITHSTANDING: 1,000VAC r.m.s.  
 OPERATING TEMPERATURE: -55° C ~ +125° C  
 CONTACT RESISTANCE: 30 MillioHMS Max.  
 POWER PINS: SEE PART No. BELOW  
 SIGNAL PINS: 3 AMPS

**MECHANICAL:**

CONTACT INSERTION FORCE: 4.5 Kg Max.  
 CONTACT SEPARATOR FORCE: 0.3Kg Min.

**MATERIALS:**

CONTACTS: BRASS  
 INSULATOR: PBT UL94V-0 RATED,  
 230°C PROCESS TEMP.  
 STEEL

SHELL:

FINISH:  
 SHELL:

NICKEL

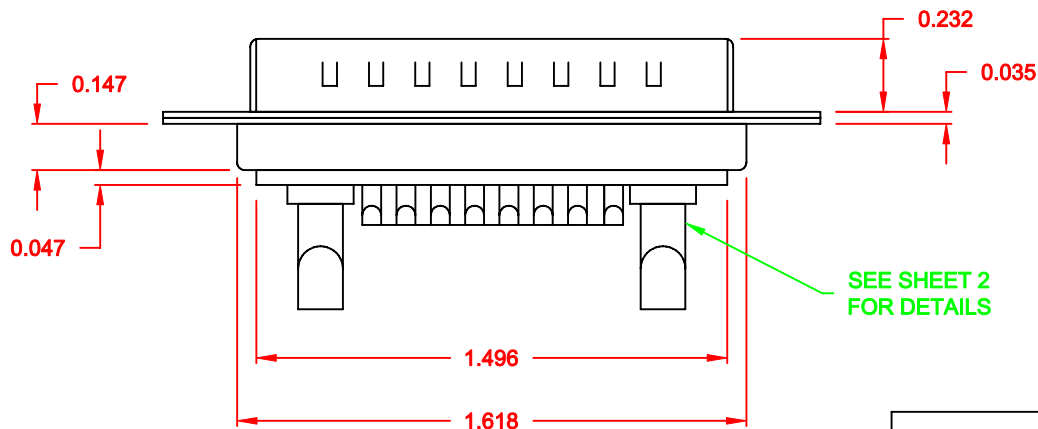
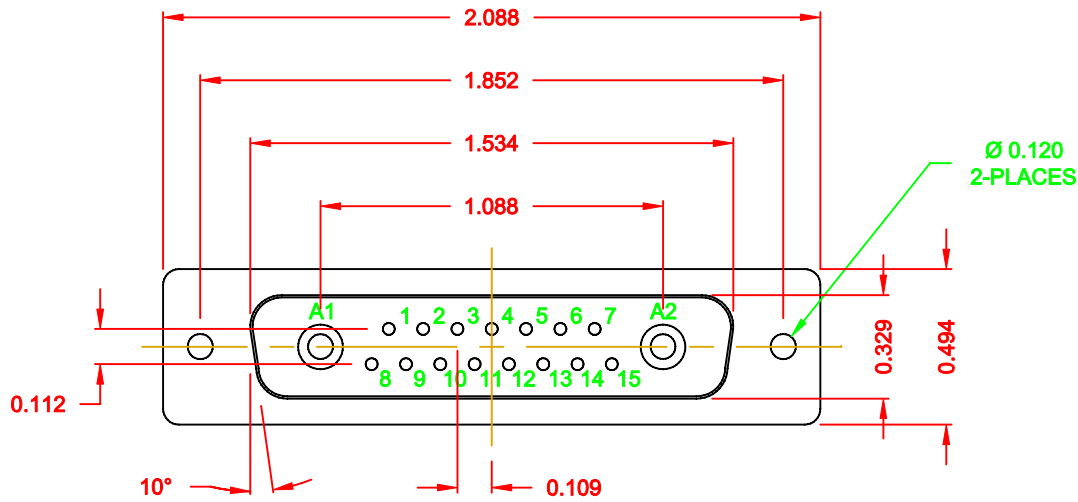

**68017W2103LYY1**

20 = 20 AMPS  
 40 = 40 AMPS

**RoHS COMPLIANT**

	THESE DRAWINGS AND SPECIFICATIONS ARE THE PROPERTY OF NorComp AND SHALL NOT BE REPRODUCED, COPIED OR USED AS THE BASIS FOR THE MANUFACTURE OR SALE OF APPARATUS WITHOUT WRITTEN PERMISSION.		DRAWN: <b>C. SMITH</b>	DATE: <b>09-13-06</b>
			CHECKED:	DATE:
<b>NorComp</b>		SCALE: <b>1.5 = 1</b>	SHEET <b>1</b> OF <b>2</b>	REV <b>1</b>
		DWG NO. <b>68017W2103LYY1</b>		

**NOTE:  
SIGNAL AND POWER CONTACTS  
COME PRE-LOADED INTO INSULATORS**

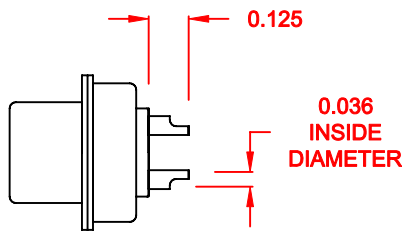

**SIGNAL CONTACTS  
ACCEPTS UP TO 20 AWG WIRE**

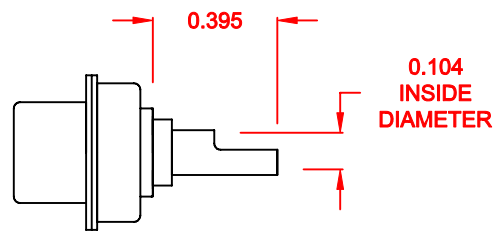

**20 AMP POWER CONTACTS  
ACCEPTS UP TO 12 AWG WIRE**

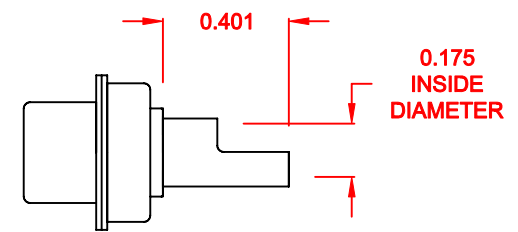

**40 AMP POWER CONTACTS  
ACCEPTS UP TO 8 AWG WIRE**

**RoHS COMPLIANT**

	THESE DRAWINGS AND SPECIFICATIONS ARE THE PROPERTY OF NorComp AND SHALL NOT BE REPRODUCED, COPIED OR USED AS THE BASIS FOR THE MANUFACTURE OR SALE OF APPARATUS WITHOUT WRITTEN PERMISSION.		DRAWN: <b>C. SMITH</b>	DATE: <b>09-13-06</b>	
			CHECKED:	DATE:	
<b>NorComp</b>		SCALE: <b>1.5 = 1</b>	SHEET <b>2</b>	OF <b>2</b>	REV <b>1</b>
		DWG NO. <b>68017W2103LYY1</b>			