

Analog Output Remote Terminal Block

SRT2-DA02

Add Analog Output Signals to a CompoBus/S System

- One or two analog outputs per terminal
- Five output ranges, switch selected:
0 to 5 V, 1 to 5 V, 0 to 10 V,
-10 to +10 V, and 4 to 20 mA
- 2 ms to convert each output point
- Resolution: 1/6000
- Terminal measures the same size as
16-point I/O terminals
- Easily mounts to DIN rail track or with
screws for panel mounting

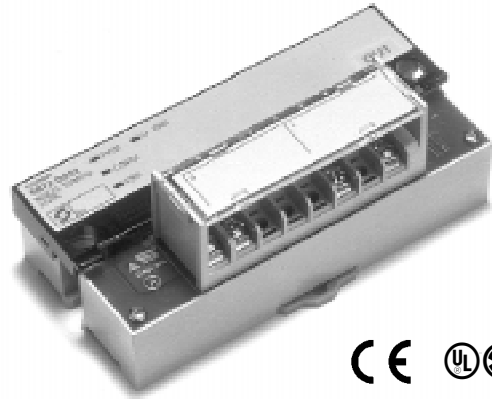

Ordering Information

Classification	I/O points	Output ranges	Part number
Analog output terminal	1 or 2 (selectable with DIP switch)	Five, selectable with DIP switch	SRT2-DA02

Note: For details about connecting the SRT2-AD04 to the Master Unit, refer to *CompoBus/S Operation Manual (W266)*.

Specifications

■ RATINGS

Output

Item	Voltage output	Current output
External output permissible load resistance	5 k Ω	600 Ω max.
Output impedance	0.5 Ω max.	---
Resolution	1/6,000 (FS)	
Total accuracy	25°C	$\pm 0.4\%$ FS
	-10°C to 55°C	$\pm 0.8\%$ FS
Conversion time	2 ms/2 points and 2 ms/1 point	
Dielectric strength	500 VAC for 1 min between communications power supply, analog output, and communications terminals (See Note)	

Note: There is no isolation between analog outputs.

■ CHARACTERISTICS

Communications power supply voltage	14 to 26.4 VDC (possible to provide through dedicated flat cable)
Current consumption	170 mA max.
Connection method	Multi-drop method and T-branch method Secondary branches cannot be connected to T-branch lines.
Dielectric strength	500 VAC between insulated circuits
Noise immunity	± 1.5 kV with a noise width of 100 ns to 1 μ s.
Vibration resistance	10 to 150 Hz, 1.0 mm double amplitude or 70 m/s ²
Shock resistance	200 m/s ²
Mounting strength	No damage with 100 N pull load applied in all directions.
Terminal strength	No damage with 100 N pull load applied
Screw tightening torque	0.3 to 0.5 N • m
Ambient temperature	Operating: -10°C to 55°C (14° to 131°F) with no icing or condensation Storage: -25°C to 65°C (-13° to 149°F) with no icing or condensation
Ambient humidity	Operating: 25% to 85% with no condensation
Weight	Approx. 100 g

Note: The current consumption above is the value with all points turned ON, excluding the current consumption of the external load.

Nomenclature

SRT2-DA02

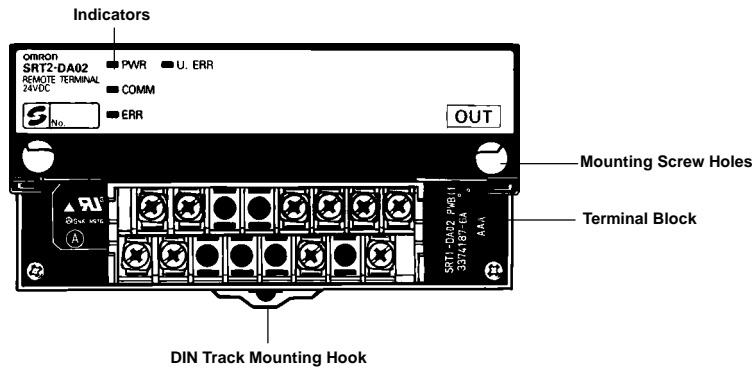

Indicators

Indicator	Name	Color	Display	Meaning
PWR	Power supply	Green	Lit	The communications power supply is ON.
			Not lit	The communications power supply is OFF.
COMM	Communication	Yellow	Lit	Normal communications
			Not lit	A communications error has occurred or the Module is in standby status.
ERR	Communication error	Red	Lit	A communications error has occurred.
			Not lit	Normal communications or the Module is in standby status.
U.ERR	Unit error	Red	Lit	An error has occurred in the Module.
			Not lit	Normal communications or the Module is in standby status.

DIP Switch (SW101)

(Open cover to access.)

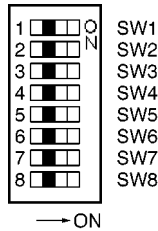

DIP Switch (SW102)

(Open cover to access.)

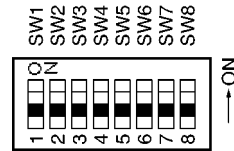

Pin 1	Be sure to turn OFF.
--------------	----------------------

Pin 2	Output points
OFF	2 points (default setting)
ON	1 point (output 0 enabled)

Pin 3	Communications mode
OFF	High-speed communications (default setting)
ON	Long-distance communications

Pin 4	Be sure to turn OFF.
--------------	----------------------

Pin no.	Node address
Pin 5	2 ³
Pin 6	2 ²
Pin 7	2 ¹
Pin 8	2 ⁰

The default setting is for all of these pins to be OFF.

Pin 1	Pin 2	Pin 3	Range for output 0
Pin 4	Pin 5	Pin 6	Range for output 1
OFF	OFF	OFF	0 to 5 V (default setting)
ON	OFF	OFF	1 to 5 V
OFF	ON	OFF	0 to 10 V
ON	ON	OFF	-10 to +10 V
OFF	OFF	ON	4 to 20 mA

Note: Do not make any settings other than the ones listed above.

Pin 7	Pin 8	Output during communications error
OFF	OFF	Clear at the output lower limit when communications error occurs. (default setting)
OFF	ON	Clear at the output upper limit when communications error occurs.
ON	OFF	Clear at the output lower limit when communications error occurs (however, if the range is -10 to +10 V, the output will be 0).
ON	ON	Output held when communications error occurs.

Dimensions

Unit: mm (inch)

SRT2-AD04

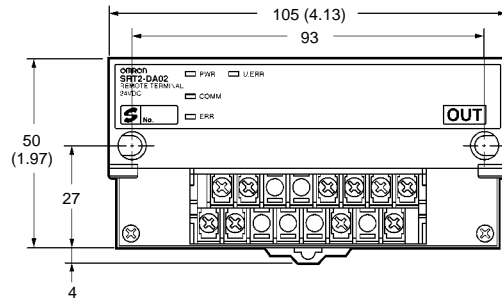
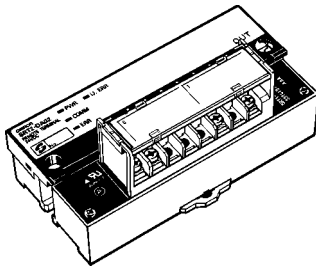

Mounting Holes

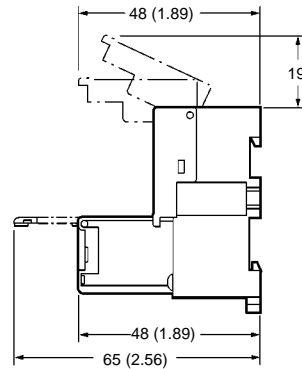
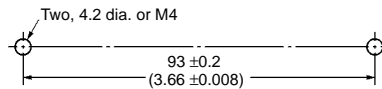

Installation

INTERNAL CIRCUIT CONFIGURATION

TERMINAL ARRANGEMENT

SRT2-DA02

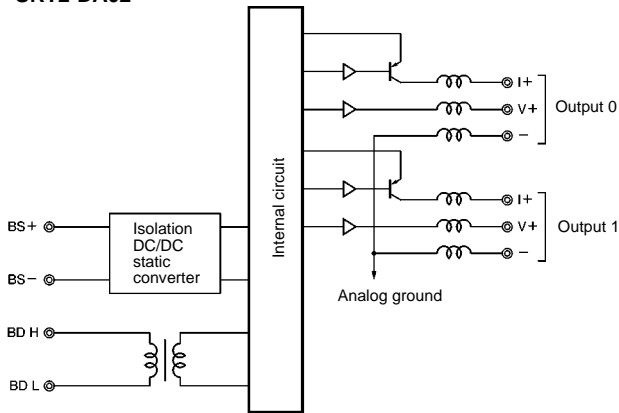

SRT2-DA02

H	BS +	NC	NC	V0 +	I0 +	V1 +	I1 +
BD L	BS -	NC	NC	NC 0-	NC	1-	

Precautions

Refer to the *CompoBus/S Operation Manual (W266)* before using the Unit.

MASTER MODULE COMPATIBILITY

Connections cannot be made to the following CompoBus/S Master Modules. If the following MasterModules are connected, incorrect data may be transferred.

- C200HW-SRM21 (-V1 and later versions supported)
- CQM1-SRM21 (-V1 and later versions supported)
- SRM1-C0□, SRM1-C0□-1 (-V2 and later versions supported)
- C200PC-ISA□2-SRM
- 3G8B3-SRM0□
- SDD-CS1 (made by NKE Ltd.)

NOTE: DIMENSIONS SHOWN ARE IN MILLIMETERS. To convert millimeters to inches divide by 25.4.

OMRON[®]**OMRON ELECTRONICS, INC.**One East Commerce Drive
Schaumburg, IL 60173**1-800-55-OMRON****OMRON CANADA, INC.**885 Milner Avenue
Scarborough, Ontario M1B 5V8**416-286-6465**