

# Generation 3

## CXM-14 COB Arrays

### White LED



#### Table of Contents

Technology Overview .....2

Test Specifications .....2

Chromaticity Bins .....3

Product Ordering & Shipping  
Part Numbers .....4

Customer Part Numbers ... .5

Operating Characteristics ..6

Optical and Electrical Character-  
istics.....7

Spectra .....8

Mechanical Dimensions ... .9

Packaging Information ....9

Handling Notes ..... 10

#### Features:

- High lumen output and efficacy typical
  - Over 3,600 lm, 148 LPW @ 3000K, 80 CRI, Tj = 85°C
  - Over 4,095 lm, 168 LPW @ 5000K, 70 CRI, Tj = 85°C
- Complete CCT range 2700K, 3000K, 3500K, 4000K, 5000K and 6500K
- 80 or 90 CRI min. up to 95 min. with high R9 in warm white
- 3 SDCM color binning accuracy
- Excellent optical emission uniformity and color over angle consistency
- Exceptional long term color stability
- Superior thermal conductivity for uniform heat spreading
- Environmentally friendly: RoHS and REACH compliant
- 

#### Applications

- |                           |                                 |
|---------------------------|---------------------------------|
| • Spotlights/Track Lights | • Architectural and Specialty   |
| • Downlights              | • Street Lighting               |
| • Shop Lighting           | • Parking Lot and Area Lighting |
| • Hospitality Lighting    | • Tunnel Lighting               |

## Technology Overview

Luminus Chip-on-Board (COB) LED series offers a complete lighting class solution designed for high performance illumination applications. The selection covers a wide lumen range from less than 400lm to over 20,000lm, all major color temperatures and can deliver color rendering greater than 97 at 2700K and 3000K and R9 equal to 95. These breakthroughs allow illumination engineers and designers to develop lighting solutions with maximum efficacy, brightness and overall quality.

### Reliability

Designed from the ground up, the Luminus COB LED is one of the most reliable light sources in the world today. Having passed a rigorous suite of environmental and mechanical stress tests, including mechanical shock, vibration, temperature cycling and humidity. Only then are the devices qualified for use in a wide range of lighting application including some of the most demanding commercial applications. Delivered with fully qualified LM80 test data and TM21 lifetime results that certify lumen maintenance at 35,000 hours or more, Luminus COB LEDs are ready for the toughest challenges.

### UL Recognized Compliance

Luminus COB arrays are tested in accordance with ANSI/UL 8750 to ensure safe operation for their intended applications.

### REACH & RoHS Compliance

All LED products manufactured by Luminus are REACH and RoHS compliant and free of hazardous materials, including lead and mercury.

## Understanding Luminus COB LED Test Specifications

Every Luminus LED is fully tested to ensure it meets the high quality standards customers have come to expect from Luminus' products.

### Traceability

Each Luminus COB LED is marked with a 2D bar code that contains a unique serial number. With this serial number, Luminus has the ability to provide customers with actual test data measurements for a specific LED. In addition, the 2D bar code is linked to manufacturing date codes that enables traceability of production processes and materials.

### Chromaticity Bin Range

Chromaticity binning delivers color consistency for every order. Standard products are delivered with a 3-step MacAdam ellipse. This ensures color performance matching in the application. For the most demanding application, Luminus is one of only a few companies that can provide a 2-step ellipse bin. These tightly controlled, small distribution bins provide customers predictable, repeatable colors.

### Testing Temperature

Luminus COB products are measured at temperatures typical for the LED operating in the fixture. Each device is tested at 85°C junction temperature eliminating the need to scale data sheet specifications to real world situations.

## Chromaticity Bin Structure

Chromaticity Bins: 1931 CIE Curve

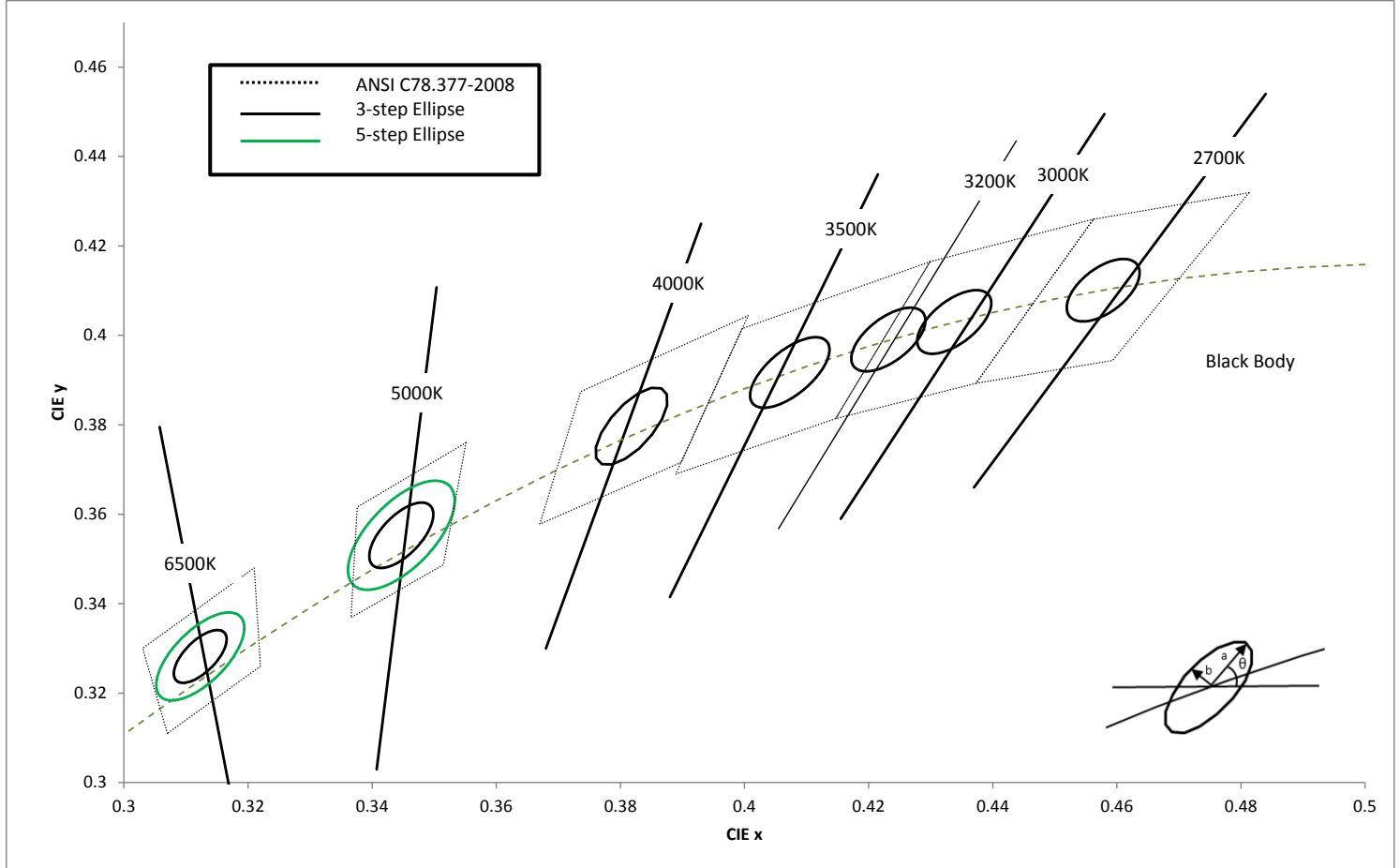

### CXM-14 White Chromaticity Bins

The following tables describe the ANSI bin center points, the orientation angle for the MacAdam ellipse ( $\theta^\circ$ ), and the maximum radii for the ellipses. The ANSI Bin is provided for reference.

| CCT   | Center Point     |                  | Angle<br>$\theta^\circ$ | 3-step Bin |         | 5-step Bin |         |
|-------|------------------|------------------|-------------------------|------------|---------|------------|---------|
|       | CIE <sub>x</sub> | CIE <sub>y</sub> |                         | a          | b       | a          | b       |
| 2700K | 0.4578           | 0.4101           | 53.7                    | 0.0081     | 0.0042  |            |         |
| 3000K | 0.4338           | 0.403            | 53.2                    | 0.00834    | 0.00408 |            |         |
| 3200K | 0.4232           | 0.3991           | 53.2                    | 0.0108     | 0.0056  |            |         |
| 3500K | 0.4073           | 0.3917           | 54                      | 0.00927    | 0.00414 |            |         |
| 4000K | 0.3818           | 0.3797           | 53.7                    | 0.00939    | 0.00402 |            |         |
| 5000K | 0.3447           | 0.3553           | 59.6                    | 0.00822    | 0.00354 | 0.0137     | 0.0059  |
| 6500K | 0.3123           | 0.3282           | 58.57                   | 0.00669    | 0.00285 | 0.01115    | 0.00475 |

\*Note: Luminus maintains a +/- 0.005 tolerance on chromaticity (CIE<sub>x</sub> and CIE<sub>y</sub>) measurements.

## Product Ordering and Shipping Part Number Nomenclature

All CXM-14 products are packaged and labeled with part numbers as outlined in the table on page 5. When shipped, each package will contain only a single flux and chromaticity bin. The part number designation is as follows:

| CXM-14                                      |                                 |                           |                             |                   |                      |          |                     |    |   |      |   |    |   |   |
|---|---------------------------------|---------------------------|-----------------------------|-------------------|----------------------|----------|---------------------|----|---|------|---|----|---|---|
| CXM   | —                               | 14                        | —                           | NN                | —                    | XX       | —                   | 36 | — | QQPP | — | FG | — | W |
| Product Family                              | Light Emitting Surface Diameter | Color Temperature         | Color Rendering Index (CRI) | Voltage (typical) | Package Configurator | Flux Bin | Chromaticity Bin    |    |   |      |   |    |   |   |
| CXM: Chip on Board, High Density, Multi-die | 14.3: LES Diameter (mm)         | Color<br>See Note 1 below | CRI                         | Volts             | AC30                 | Lumens   | See page 3 for bins |    |   |      |   |    |   |   |

Note 1: NN nomenclature corresponds to the following:

- 27 = 2700K
- 30 = 3000K
- 35 = 3500K
- 40 = 4000K
- 50 = 5000K
- 65 = 6500K

Note 2: AC is standard package configurator

AA is an alternative

### Color Temperature, CRI and R9 Values

| Color Temperatures                       | XX Value | CRI | R9  |
|--|----------|-----|-----|
| 4000K, 5000K, 6500K                      | 70       | >70 | -   |
| 2700K, 3000K, 3500K, 4000K, 5000K, 6500K | 80       | >80 | >0  |
| 2700K, 3000K, 3500K, 4000K, 5000K        | 90       | >90 | >50 |
| 2700K, 3000K, 3200K                      | 95       | >95 | >85 |
| 3500K                                    |          |     | >80 |

Note: Luminus part numbers may be accompanied by prefixes or suffixes. The most common is the "Rev01" suffix indicating a part is fully released and carries a full warranty. These additional characters may appear on shipping labels, packing slips and invoices. In all cases the basic part number described above will always be included.

**CXM-14 Part Numbers**

The following tables describe products with typical flux and minimum flux measured at 720mA and specified at 85°C. The values at 25°C are calculated and shown for reference only. All product is measured and specified at 85°C junction temperature

| CCT   | Output Flux (lm) |             | Reference                | Color Rendering Index | Ordering Part Number      |
|-------|------------------|-------------|--------------------------|-----------------------|---------------------------|
|       | Typ. (85°C)      | Min. (85°C) | Typ. (calculated) (25°C) | CRI (min.)            | 3-step MacAdam Ellipse    |
| 2700K | 3,410            | 3,110       | 3,610                    | 80                    | CXM-14-27-80-36-AC30-F4-3 |
|       | 2,810            | 2,560       | 2,975                    | 90                    | CXM-14-27-90-36-AC30-F4-3 |
|       | 2,685            | 2,450       | 2,845                    | 95                    | CXM-14-27-95-36-AC30-F4-3 |
| 3000K | 3,600            | 3,285       | 3,810                    | 80                    | CXM-14-30-80-36-AC30-F4-3 |
|       | 3,030            | 2,760       | 3,210                    | 90                    | CXM-14-30-90-36-AC30-F4-3 |
|       | 2,830            | 2,580       | 2,995                    | 95                    | CXM-14-30-95-36-AC30-F4-3 |
| 3500K | 3,710            | 3,380       | 3,925                    | 80                    | CXM-14-35-80-36-AC30-F4-3 |
|       | 3,090            | 2,815       | 3,270                    | 90                    | CXM-14-35-90-36-AC30-F4-3 |
|       | 2,955            | 2,695       | 3,130                    | 95                    | CXM-14-35-95-36-AC30-F4-3 |
| 4000K | 4,030            | 3,675       | 4,265                    | 70                    | CXM-14-40-70-36-AC30-F4-3 |
|       | 3,755            | 3,425       | 3,975                    | 80                    | CXM-14-40-80-36-AC30-F4-3 |
|       | 3,260            | 2,970       | 3,450                    | 90                    | CXM-14-40-90-36-AC30-F4-3 |

| CCT   | Output Flux (lm) |             | Reference                | Color Rendering Index | Part Number               |                           |
|-------|------------------|-------------|--------------------------|-----------------------|---------------------------|---------------------------|
|       | Typ. (85°C)      | Min. (85°C) | Typ. (calculated) (25°C) | CRI (min.)            | 5-step MacAdam Ellipse    | 3-step MacAdam Ellipse    |
| 5000K | 4,095            | 3,735       | 4,335                    | 70                    | CXM-14-50-70-36-AC30-F4-5 | CXM-14-50-70-36-AC30-F4-3 |
|       | 3,785            | 3,450       | 4,005                    | 80                    | CXM-14-50-80-36-AC30-F4-5 | CXM-14-50-80-36-AC30-F4-3 |
|       | 3,275            | 2,985       | 3,470                    | 90                    | CXM-14-50-90-36-AC30-F4-5 | CXM-14-50-90-36-AC30-F4-3 |
| 6500K | 4,100            | 3,740       | 4,340                    | 70                    | CXM-14-65-70-36-AC30-F4-5 | CXM-14-65-70-36-AC30-F4-3 |
|       | 3,770            | 3,435       | 3,990                    | 80                    | CXM-14-65-80-36-AC30-F4-5 | CXM-14-65-80-36-AC30-F4-3 |

\*Note: Luminus maintains a +/- 6% tolerance for flux measurements.

Luminus maintains a +/- 2% tolerance for CRI measurements.

**CXM-14 Part Numbers**

The following tables describe products with typical flux and minimum flux measured at 720mA and specified at 85°C. The values at 25°C are calculated and shown for reference only. All product is measured and specified at 85°C junction temperature

| CCT   | Output Flux (lm) |             | Reference                | Color Rendering Index | Ordering Part Number      |
|-------|------------------|-------------|--------------------------|-----------------------|---------------------------|
|       | Typ. (85°C)      | Min. (85°C) | Typ. (calculated) (25°C) | CRI (min.)            | 3-step MacAdam Ellipse    |
| 2700K | 3,410            | 3,110       | 3,610                    | 80                    | CXM-14-27-80-36-AA30-F4-3 |
|       | 2,810            | 2,560       | 2,975                    | 90                    | CXM-14-27-90-36-AA30-F4-3 |
|       | 2,685            | 2,450       | 2,845                    | 95                    | CXM-14-27-95-36-AA30-F4-3 |
| 3000K | 3,600            | 3,285       | 3,810                    | 80                    | CXM-14-30-80-36-AA30-F4-3 |
|       | 3,030            | 2,760       | 3,210                    | 90                    | CXM-14-30-90-36-AA30-F4-3 |
|       | 2,830            | 2,580       | 2,995                    | 95                    | CXM-14-30-95-36-AA30-F4-3 |
| 3200K | 2,850            | 2,650       | 3,135                    | 95                    | CXM-14-32-95-36-AA30-F4-3 |
| 3500K | 3,710            | 3,380       | 3,925                    | 80                    | CXM-14-35-80-36-AA30-F4-3 |
|       | 3,090            | 2,815       | 3,270                    | 90                    | CXM-14-35-90-36-AA30-F4-3 |
|       | 2,955            | 2,695       | 3,130                    | 95                    | CXM-14-35-95-36-AA30-F4-3 |
| 4000K | 4,030            | 3,675       | 4,265                    | 70                    | CXM-14-40-70-36-AA30-F4-3 |
|       | 3,755            | 3,425       | 3,975                    | 80                    | CXM-14-40-80-36-AA30-F4-3 |
|       | 3,260            | 2,970       | 3,450                    | 90                    | CXM-14-40-90-36-AA30-F4-3 |

| CCT   | Output Flux (lm) |             | Reference                | Color Rendering Index | Part Number               |                           |
|-------|------------------|-------------|--------------------------|-----------------------|---------------------------|---------------------------|
|       | Typ. (85°C)      | Min. (85°C) | Typ. (calculated) (25°C) | CRI (min.)            | 5-step MacAdam Ellipse    | 3-step MacAdam Ellipse    |
| 5000K | 4,095            | 3,735       | 4,335                    | 70                    | CXM-14-50-70-36-AA30-F4-5 | CXM-14-50-70-36-AA30-F4-3 |
|       | 3,785            | 3,450       | 4,005                    | 80                    | CXM-14-50-80-36-AA30-F4-5 | CXM-14-50-80-36-AA30-F4-3 |
|       | 3,275            | 2,985       | 3,470                    | 90                    | CXM-14-50-90-36-AA30-F4-5 | CXM-14-50-90-36-AA30-F4-3 |
|       | 3,020            | 2,750       | 3,195                    | 95                    | CXM-14-50-95-36-AA30-F4-5 | CXM-14-50-95-36-AA30-F4-3 |
| 6500K | 4,100            | 3,740       | 4,340                    | 70                    | CXM-14-65-70-36-AA30-F4-5 | CXM-14-65-70-36-AA30-F4-3 |
|       | 3,770            | 3,435       | 3,990                    | 80                    | CXM-14-65-80-36-AA30-F4-5 | CXM-14-65-80-36-AA30-F4-3 |

\*Note: Luminus maintains a +/- 6% tolerance for flux measurements.

Luminus maintains a +/- 2% tolerance for CRI measurements.

**CXM-14 Operating Characteristics<sup>1</sup>**
**Optical and Electrical Characteristics**

| Parameter                               | Symbol        | Minimum | Typical | Maximum | Unit   |
|---|---------------|---------|---------|---------|--------|
| Forward Current <sup>2</sup>            | $I_f$         |         | 720     | 1,450   | mA     |
| Forward Voltage <sup>3</sup>            | $V_f$         | 31      | 34      | 37      | V      |
| Power                                   |               |         | 24.5    | 54      | W      |
| Operating Case Temperature <sup>4</sup> | $T_c$         |         |         | 105     | °C     |
| Light Emitting Surface Diameter         | LES           |         | 14.3    |         | mm     |
| Thermal Resistance (junction-to-case)   | $\Theta_{jc}$ | 0.45    |         |         | °C/W   |
| Junction Temperature                    | $T_j$         |         |         | 140     | °C     |
| Viewing Angle                           |               |         | 120     |         | Degree |

Note 1: Ratings are based on operation at a constant junction temperature of  $T_j = 85^\circ\text{C}$ .

Note 2: To prevent damage refer to operating conditions and derating curves for appropriate maximum operating conditions

Note 3: Voltage is rated at typical forward current. For voltage at higher drive current, refer to performance graphs.

Note 4: Device operation not recommended at drive currents less than 10% of the typical value

Note 5: Caution must be taken not to stare at the light emitted from these LEDs. Under special circumstances, the high intensity could damage the eye.

Note 6: All product operating specifications are subject to change without advance notice.

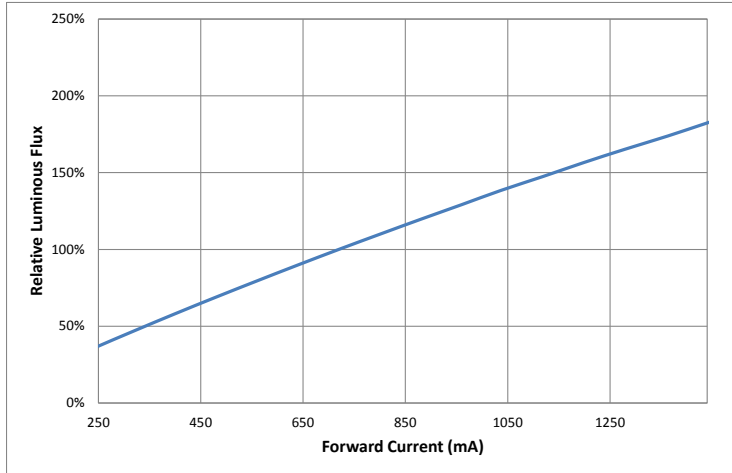
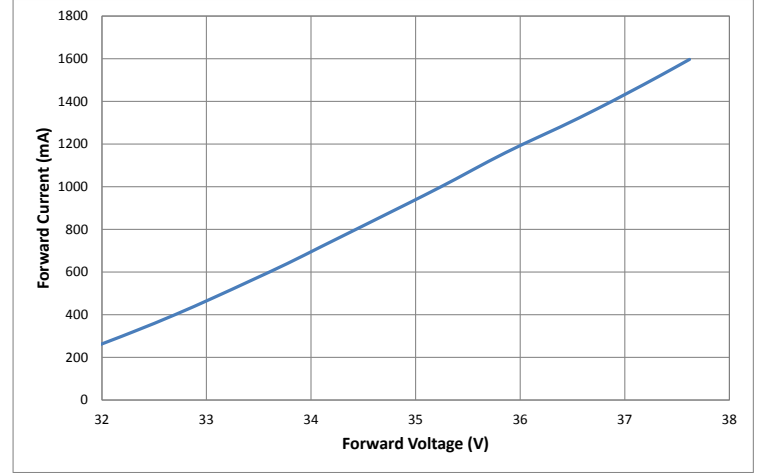
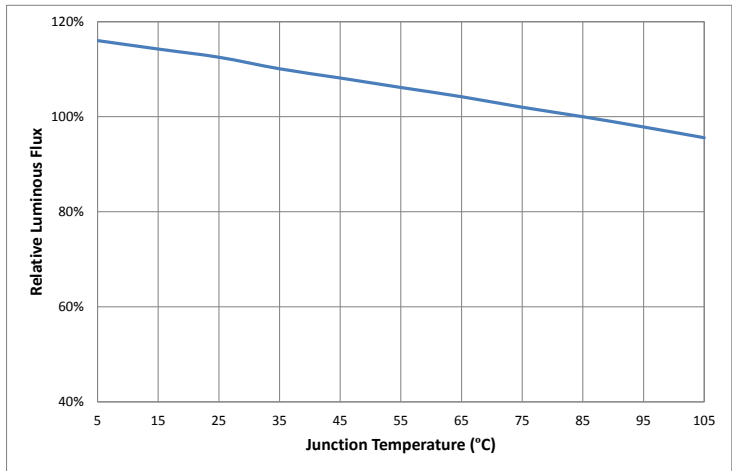
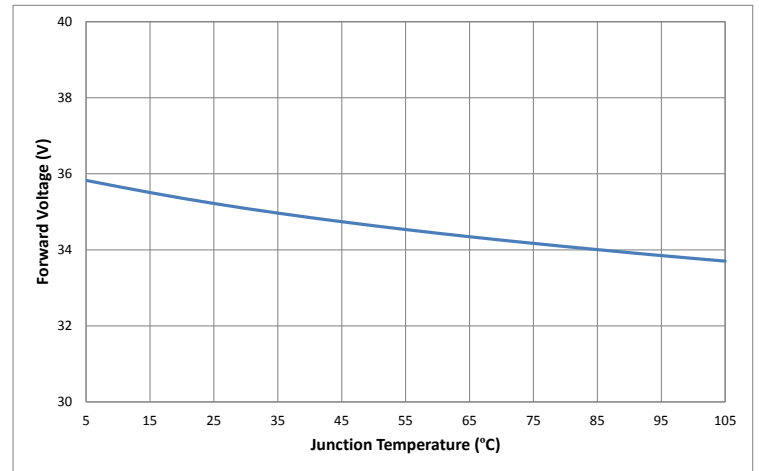
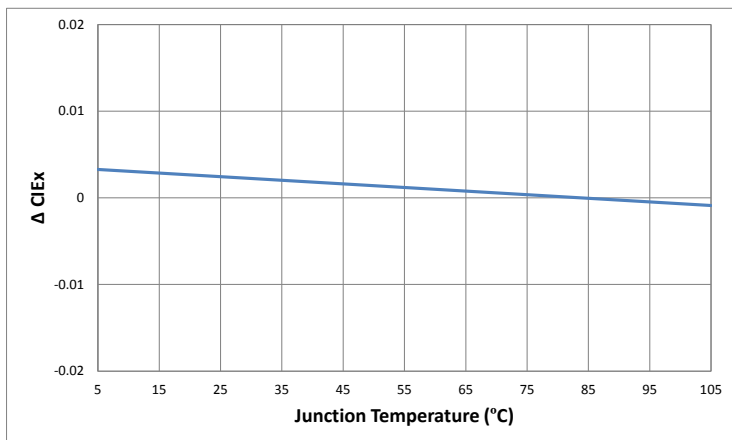
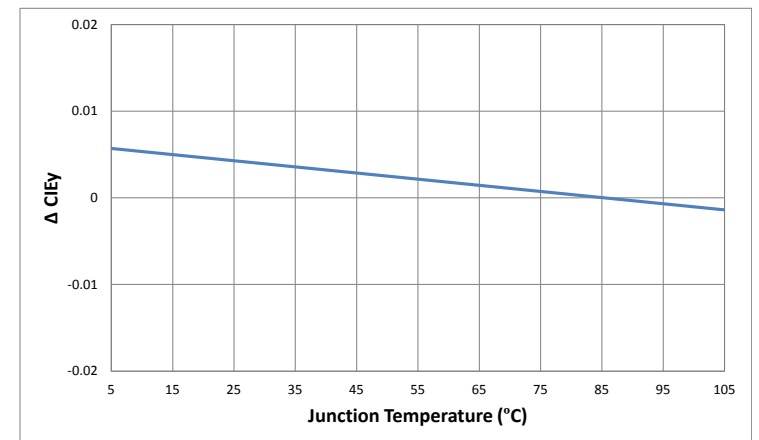
**CXM-14 Optical & Electrical Characteristics**
**Relative Output Flux vs. Forward Current @ 85°C**

**Forward Current vs. Forward Voltage @ 85°C**

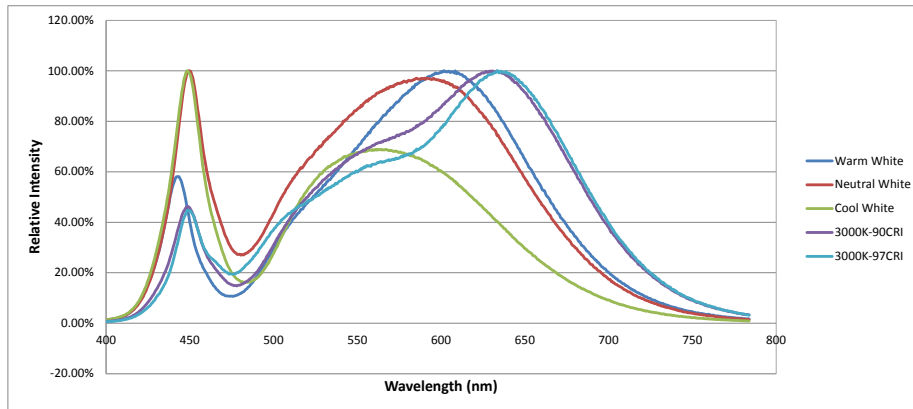
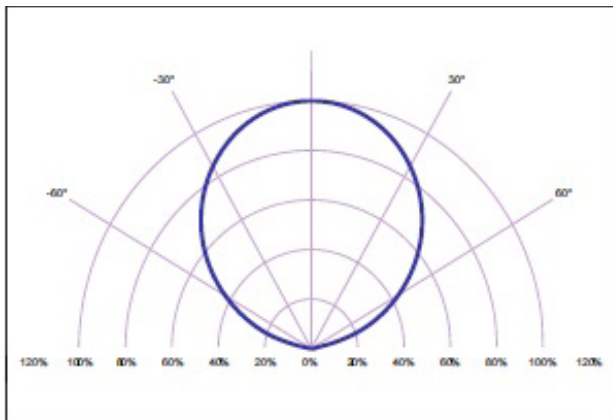
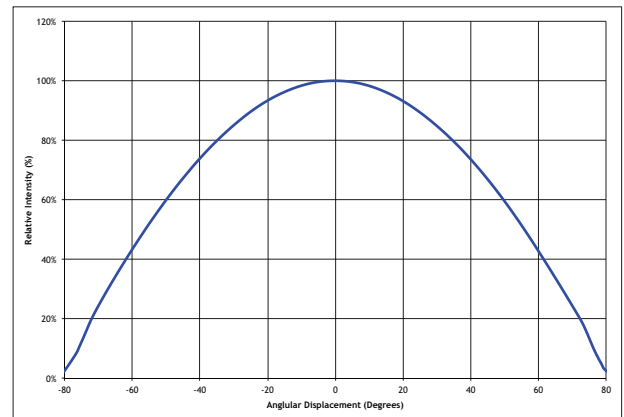
**Relative Output Flux vs. Junction Temperature**

**Change in Voltage vs. Junction Temperature**

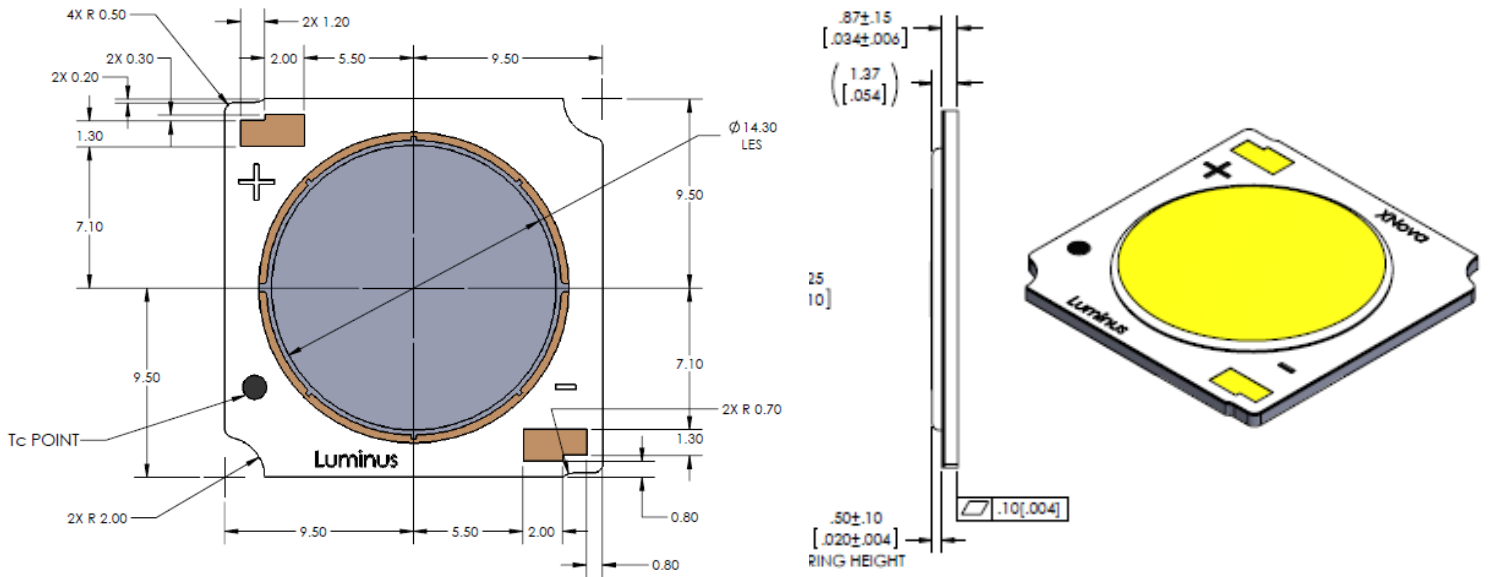
**Change in CIE<sub>x</sub> vs. Junction Temp. (3000K, 80CRI)**

**Change in CIE<sub>y</sub> vs. Junction Temp. (3000K, 80CRI)**



**CXM-14 Optical & Electrical Characteristics**
**Typical Spectrum**

**Typical Polar Radiation Pattern**

**Typical Angular Radiation Pattern**

### Mechanical Dimensions (AC30)

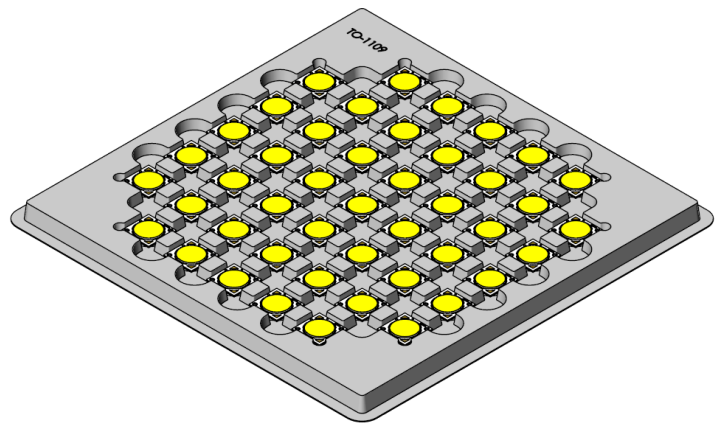
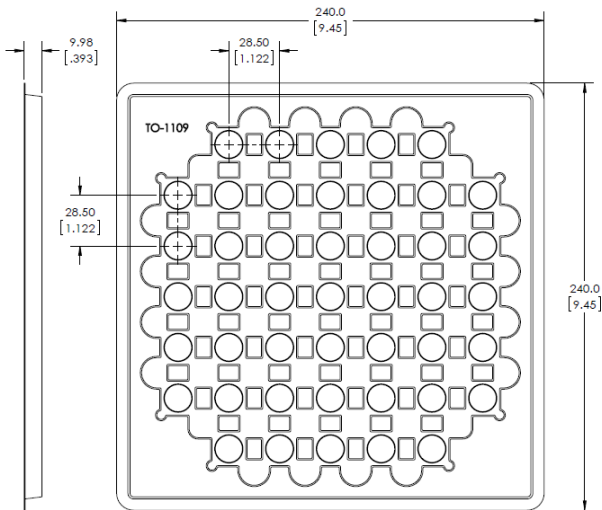

### Shipping Container



Each bag is boxed for easier storage/stacking

Trays are sealed in an anti-static bag

5 trays are stacked together with one tray as a cover

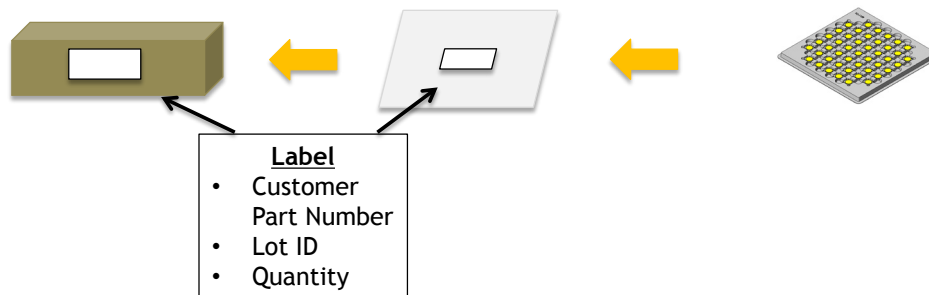

### Mechanical Dimensions (AA30)

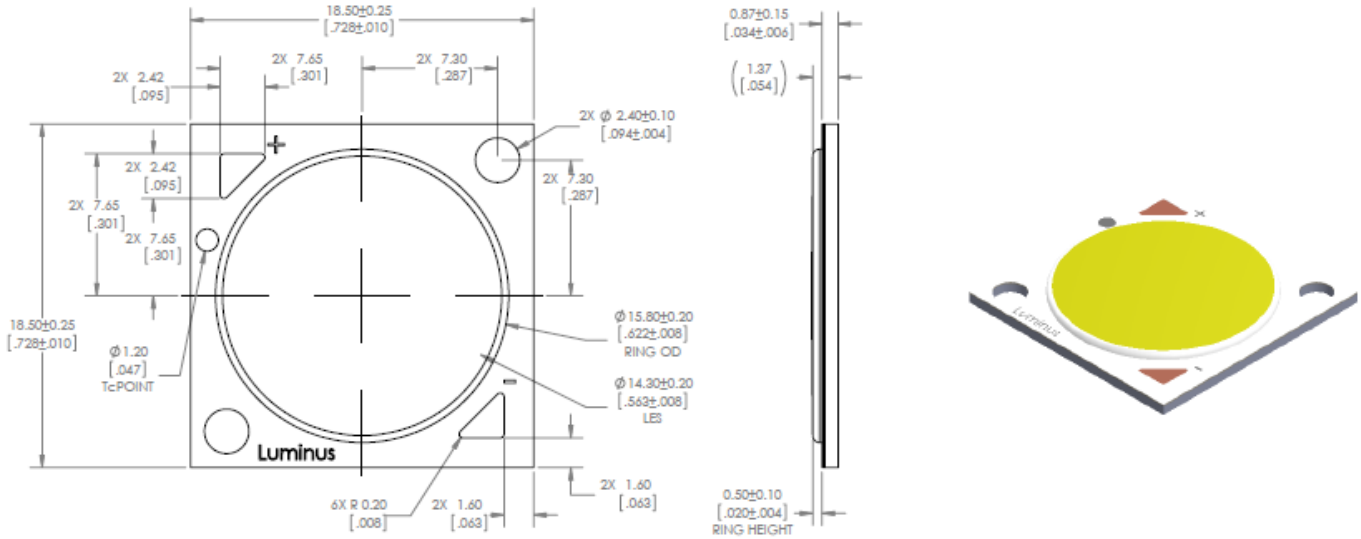

### Shipping Container

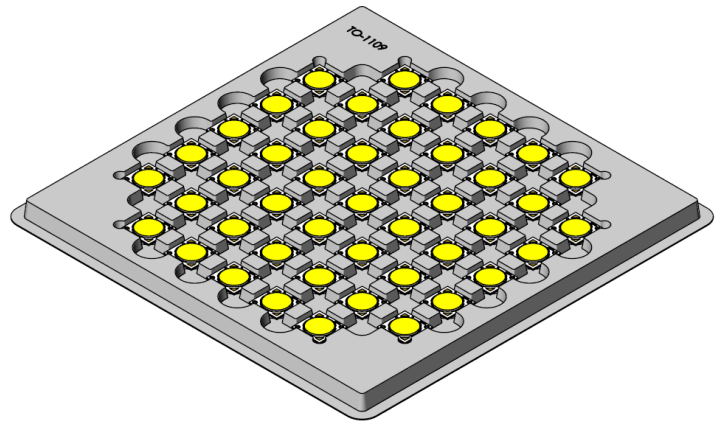
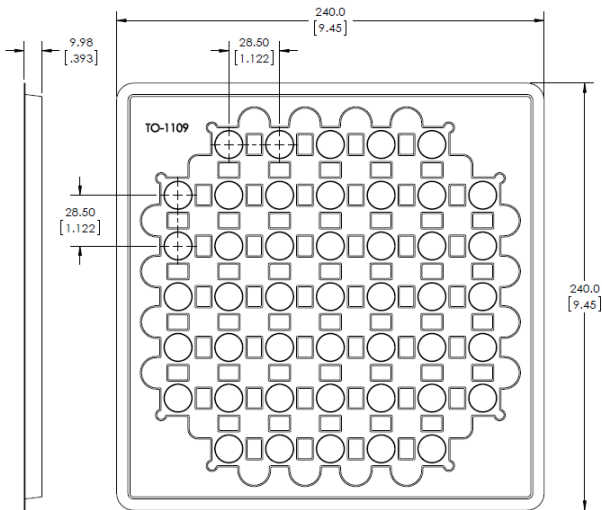

Each bag is boxed for easier storage/stacking

Trays are sealed in an anti-static bag

5 trays are stacked together with one tray as a cover

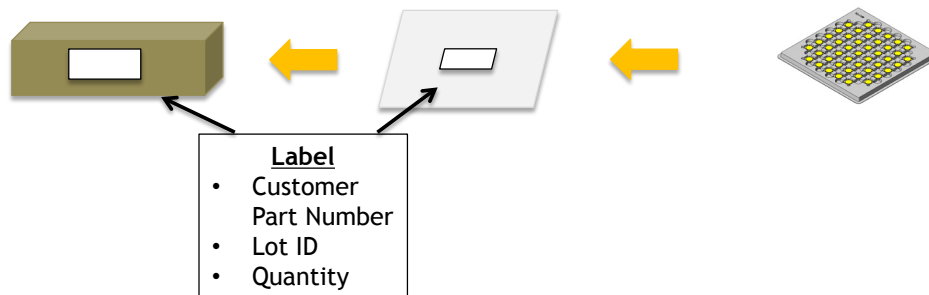

## Handling Notes for Luminus COBs

Luminus products are designed for robust performance in general lighting application. However, care must be taken when handling and assembling the LEDs into their fixtures. To avoid damaging Luminus COBs please follow these guide lines.

The following is an overview of the application notes detailing some of the practices to follow when working with these devices. More detailed information is available on the Luminus web site at [www.luminus.com](http://www.luminus.com).

### General Handling

Devices are made to be lifted or carried with tweezers on two adjacent corners opposite the contact pads. At no time should the devices be handled by or should anything come in contact with the light emitting surface (LES) area. This area includes the yellow colored circular area and the ring surrounding it. There are electrical connections under the LES which if damaged will cause the device to fail.

In addition, the ring frame itself should not be used for moving, lifting or carrying the device. Also do not attach any optics or mechanical holders to the ring as it is not capable to handle the mechanical stress.

### Static Electricity

Luminus COBs are electronic devices which can be damaged by electrostatic discharge (ESD). Please use appropriate measures to assure the devices do not experience ESD during their handling and or storage. ESD protection guidelines should be used at all times when working with Luminus COBs.

**Storage:** Luminus products are delivered in ESD shielded bags and should be stored in these bags until used.

**Assembly:** Individuals handling Luminus COBs during assembly should be trained in ESD protection practices. Assemblers should maintain constant conductive contact with a path to ground by means of a wrist strap, ankle straps, mat or other ESD protection system.

**Transporting:** When transporting the devices from one assembly area to another, ESD shielded carts and carriers should be used.

### Electrical Contact

Luminus COBs are designed with contact pads on their top surface. These pads are clearly marked with + and – polarity. Wires can be soldered to the contact pads for electrical connections or other solderless connector products are available.

If wires are being soldered to the COB product, we recommend attaching these wires prior to mounting the devices to a heat sink. Please contact Luminus for specific recommendations on how to solder wires if not familiar with the standard practice. Luminus can also offer design recommendations for jigs to allow easily soldering multiple products in rapid succession.

### Chemical Compatibility

The resin material used to form the LES can getter hydrocarbons from the surrounding environment. As a results, certain chemical compounds are not recommended for use with the Luminus products. Use of these compounds can cause damage to the light output of the device and may permanently damage the device. Please refer to [www.luminus.com](http://www.luminus.com) for a list of the compounds not recommended for use with the Luminus COB products.

### Thermal Interface Material (TIM)

Proper thermal management is critical for successful operation of any LED system. Excess operating temperature can reduce the light output of the device. And excessive heating can cause permanent damage to the device. Proper TIM material is a crucial component for effective heat transfer away from the LED during normal operation. Please refer to [www.luminus.com](http://www.luminus.com) for specific recommendations for TIM solutions.