

Capacitor, aluminum, 470 uF, +/-20% Tol, -25/+85C, 400VDC@85° C

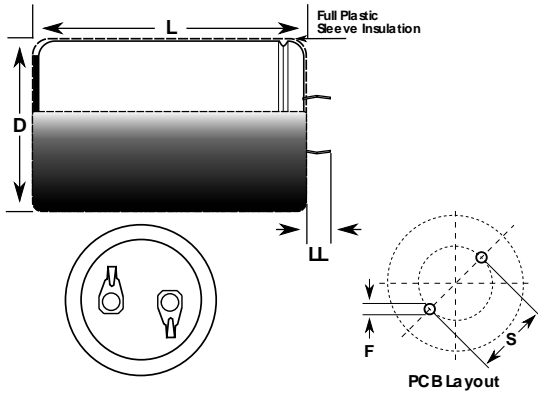

Dimensions (mm)		
Symbol	Dimension	Tolerance
D	35	+/-1
L	40	+/-2
S	10	+/-0.5
LL	5.8	+/-1
F	2	+/-0.1

Packaging Specifications	
Package Kind:	Bulk
Package Quantity:	200

General Information	
Supplier:	KEMET
Part Type Description:	Snap-In Aluminum Electrolytic
Style:	Snap-in
Lead Type:	2 Pin

Specifications	
Capacitance:	470 uF
Tolerance:	+/-20%
Rated Temperature:	85° C
Voltage @ rated temp:	400VDC
VDC Surge:	450VDC
Life @ rated temp:	2000 Hrs
RoHS:	Yes
Low Z/ESR:	Yes
Temperature Range:	-25/+85C
ESR at 100kHz @ room temp:	130 mOhm
Leakage Current:	3 mA
Leakage Condition:	5min/20c
Dissipation Factor:	15%
Ripple 120Hz @ rated temp:	2.4 A