

Front plate - VS-SI-FP-DSUB9-DSUB15-GC-BU/ST - 1657711

Please be informed that the data shown in this PDF Document is generated from our Online Catalog. Please find the complete data in the user's documentation. Our General Terms of Use for Downloads are valid (<http://download.phoenixcontact.com>)

Front plate with contact inserts, plastic, 1x D-SUB 9 and 1x D-SUB 15, socket/pin



Illustration shows the product version
VS-SI-FP-2RJ45-5-MOD-BU/BU



Key commercial data

Packing unit	1 pc
Weight per Piece (excluding packing)	45.9 GRM
Custom tariff number	85369010
Country of origin	Czech Republic

Technical data

Mechanical characteristics

Number of slots	2
Color	gray

Ambient conditions

Ambient temperature (operation)	-10 °C ... 60 °C
Degree of protection	IP20

Material data

Inflammability class according to UL 94	V0
Housing material	PBT

Electrical characteristics

Rated voltage (III/3)	125 V
Rated current	3 A

Front plate - VS-SI-FP-DSUB9-DSUB15-GC-BU/ST - 1657711

Classifications

eCl@ss

eCl@ss 4.0	27140816
eCl@ss 4.1	27140816
eCl@ss 5.0	27189239
eCl@ss 5.1	27189239
eCl@ss 6.0	27144001
eCl@ss 7.0	27144001
eCl@ss 8.0	27144001

ETIM

ETIM 2.0	EC000007
ETIM 3.0	EC000007
ETIM 4.0	EC000007
ETIM 5.0	EC000456

UNSPSC

UNSPSC 6.01	31261501
UNSPSC 7.0901	31261501
UNSPSC 11	31261501
UNSPSC 12.01	31261501
UNSPSC 13.2	31261501

Approvals

Approvals

Approvals

GOST

Ex Approvals

Approvals submitted

Approval details

Front plate - VS-SI-FP-DSUB9-DSUB15-GC-BU/ST - 1657711

Approvals



Accessories

Accessories

Marking material

Marker labels - VS-SI-BZ - 1656660



Marker label, plastic, plate with 20 labels

Drawings

Dimensioned drawing

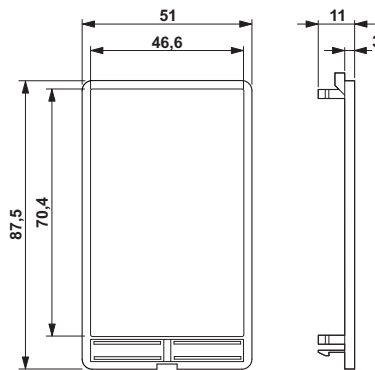

Front plate