

ED-21912-000
SHT 1.1

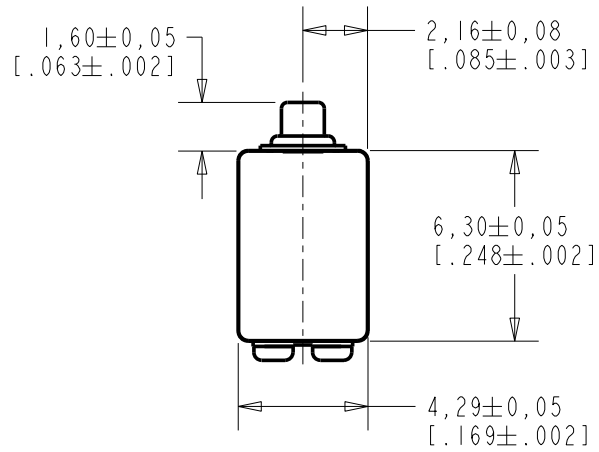

NOTE:

- 1 A POSITIVE GOING VOLTAGE AT TERMINAL 2, RELATIVE TO TERMINAL 1, CAUSES A DECREASE IN PRESSURE AT THE SOUND OUTLET.
- 2 LOCATED FROM TWO SURFACES FOR CUSTOMER CONVENIENCE. ONLY APPLICABLE FROM ONE SURFACE, NOT TO BE USED TOGETHER. HORIZONTAL LOCATION FOR TERMINAL CENTERED TO ±0,17 [.007].

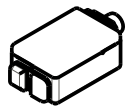
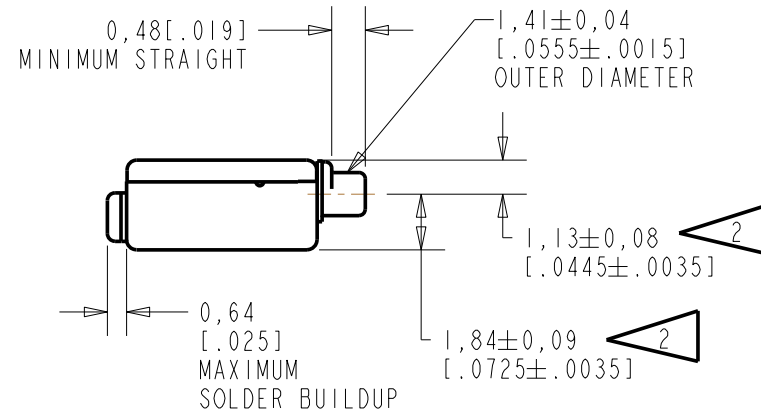
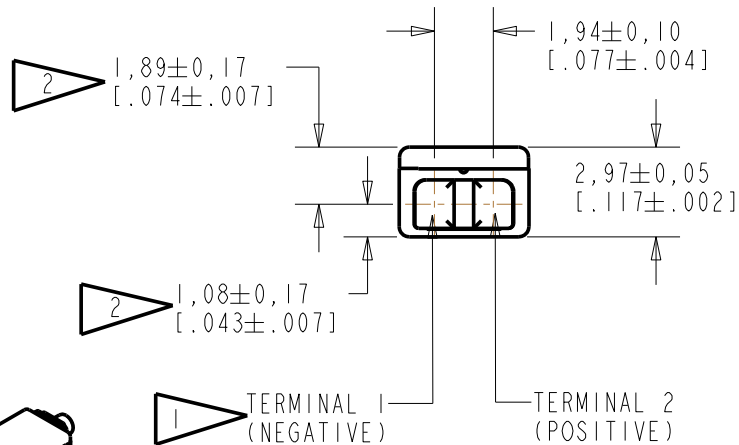

SCALE 2:1

NOMINAL WEIGHT
 .31 GRAM

DIMENSIONS IN MILLIMETERS [INCHES]

Revision	C.O. #	Implementation Date	RELEASE LEVEL	REVISION
B	CI0107990	7-31-08	Active	B
A	CI0103544	1-4-06		

SCALE: 4:1		DR. BY	DATE
DO NOT SCALE DRAWING		CRG	1-4-06
TITLE: RECEIVER		ED-21912-000	GJP 1-5-06
OUTLINE DRAWING		SHT 1.1	GJP 1-5-06

KNOWLES ELECTRONICS
 ITASCA, ILLINOIS U.S.A.

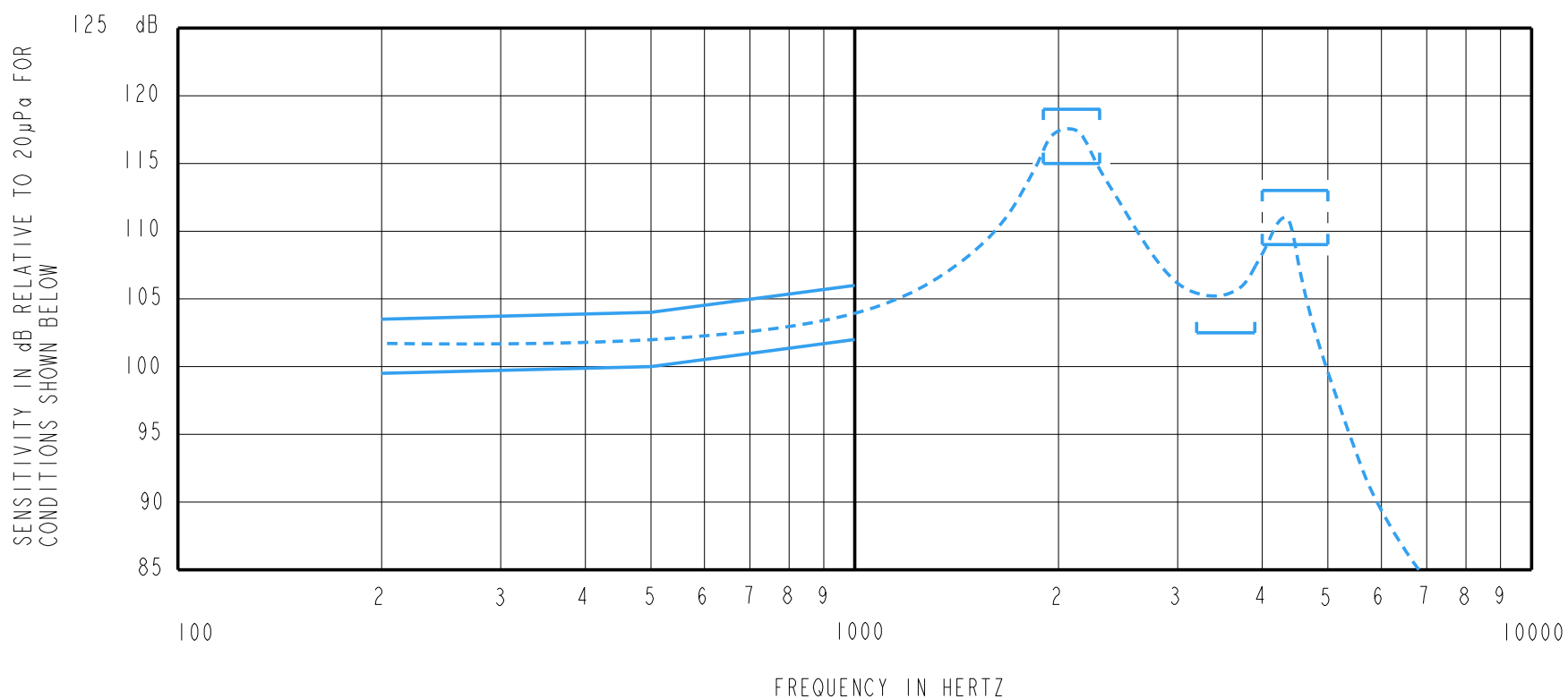

NOTES:

1. MEASUREMENTS MADE USING 10mm (.394") X 1mm (.039") ID TUBE CONNECTED TO A SIMULATED ANSI S3.7-1973 TYPE HA-3 COUPLER. (IEC 126).

2.

SENSITIVITY

FREQUENCY	MIN.	MAX.
200	99.5	103.5
500	100.0	104.0
1000	102.0	106.0
1900-2300	115.0	119.0
3200-3900	102.5	---
4000-5000	109.0	113.0

3. RESPONSE, IMPEDANCE, AND DISTORTION MEASUREMENTS MADE USING THE ELECTRICAL TEST CONDITIONS SHOWN BELOW.

4. ELECTRICAL SOURCE IMPEDANCE MUST BE GREATER THAN 20 TIMES 1KHz IMPEDANCE FOR TEST CONDITIONS SHOWN BELOW.

5. INDIVIDUAL SPECIFICATIONS.

PORT LOCATION	IMPEDANCE OHMS ±15%		DCR @20°C OHMS ±10%	DISTORTION		ELECTRICAL TEST CONDITIONS	
	1KHz	500Hz		MAX. %	FREQ Hz	AC mA RMS	DC mA
12C	725	395	196	5	800	0.70	1.00

Revision	C.O. #	Implementation Date	RELEASE LEVEL	REVISION
B	C10107990	7-31-08	Active	B
A	C10103544	1-4-06		

KNOWLES ELECTRONICS
ITASCA, ILLINOIS U.S.A.

WHEN TEST LIMITS ARE USED TO ESTABLISH INCOMING INSPECTION ACCEPTANCE/REJECTION CRITERIA, CORRELATION OF TEST EQUIPMENT WITH KNOWLES IS ALSO REQUIRED FOR ELIMINATION OF EQUIPMENT AND TEST METHOD VARIATION

TITLE: **RECEIVER**
PERFORMANCE SPECIFICATION

ED-21912-000
SHT 2.1

DR. BY	DATE
CRG	1-4-06
CK. BY	DATE
GJP	1-5-06
APP. BY	DATE
GJP	1-5-06