

DETAILS

Product Number	CA13758_STRADA-SQ-FS-NP
Family	Strada
Type	Assembly
Color	clear
Diameter	25x25 mm
Height	12,6 mm
Style	square
Optic Material	PMMA
Holder Material	
Fastening	tape
Status	production ready
ROHS Compliant	Yes
Date Updated	26/08/2014

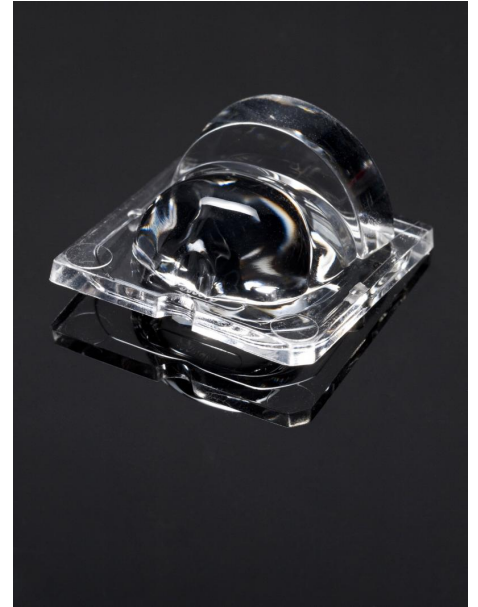

OPTICAL PROPERTIES

LED	Viewing Angle	Light Beam	Efficiency	cd/lm	Connector
PSL440	Asymmetric deg	Asymmetric	93 %	1.080	-
PSL445	Asymmetric deg	Asymmetric	92 %	0.760	-
MK-R	asymmetric deg	Asymmetric	93 %	0.900	-
XM-L	asymmetric deg	Asymmetric	93 %	1.200	-
XT-E	asymmetric deg	Asymmetric	93 %	1.200	-
XP-L	Asymmetric deg	Asymmetric	93 %	1.100	-
XHP50	Asymmetric deg	Asymmetric	94 %	0.900	-
XHP70	asymmetric deg	Asymmetric	80 %	0.620	Undefined Manufacturer: Protective Plate, Glass
XP-L2	Asymmetric deg	Asymmetric	93 %	0.990	-
LUXEON M/MX	asymmetric deg	Asymmetric	92 %	0.900	-
LUXEON MZ	asymmetric deg	Asymmetric	93 %	1.200	-
LUXEON XR-M linear 1x3, 1x4, 1x5	Asymmetric deg	Asymmetric	94 %	0.970	-
Duris S10	Asymmetric deg	Asymmetric	92 %	0.880	-
Duris P10	sim: Asymmetric	Asymmetric	sim: 90 %	sim: 1.000	-

D

C

B

A

4

4

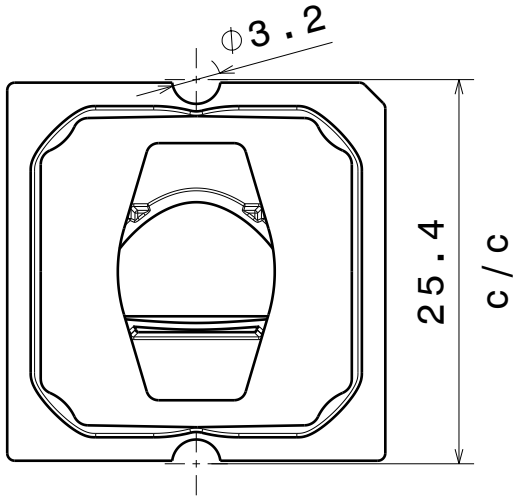

Bottom view

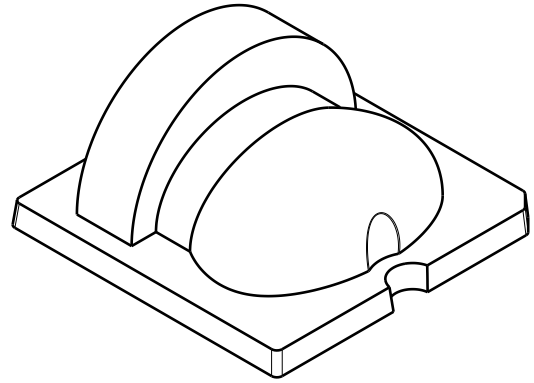

Isometric view

3

3

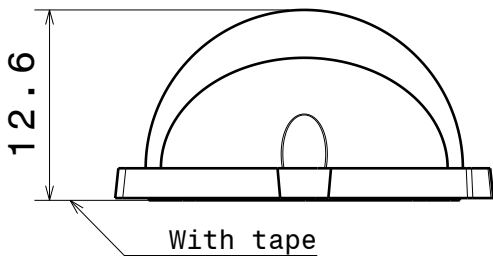

Front view

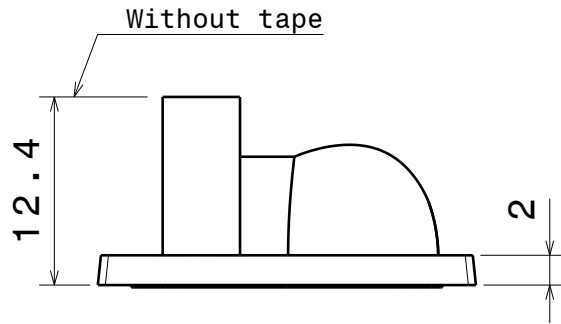

Left view

2

2

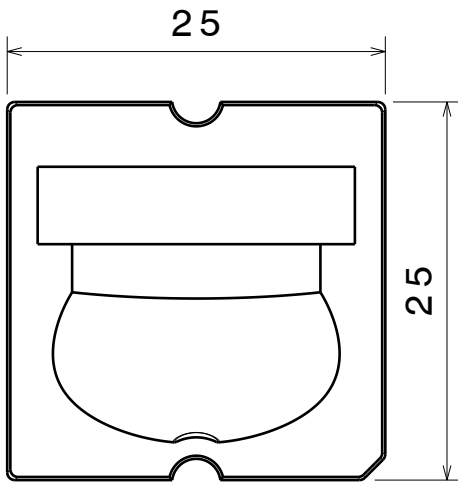

Top view

Tolerances if not otherwise shown
 According to DIN ISO 2768-1
 Linear measures:
 Up to 30mm class M, otherwise class C.
 According to DIN ISO 2768-2
 Form and position: class L

LEDiL Ledil Oy
 Salorankatu 10
 FIN 24240 SALO
 Finland

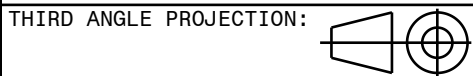

DRAWING TITLE

STRADA-SQ-FS-NP

This drawing is the property
 of LEDiL Oy. It may not be
 reproduced, copied or
 communicated without a written
 agreement with LEDiL Oy."

SIZE	PART NUMBER
A4	-

SCALE	2:1	WEIGHT	- g	SHEET	1/1
-------	-----	--------	-----	-------	-----

D

A

1

1

Luminaire: LEDiL Oy CA13758_STRADA-SQ-FS-NP_(PSL440)
Lamps: 1 x Citizen_PSL440_256.951lm@250mA_P=2.8697W_I=0.250A

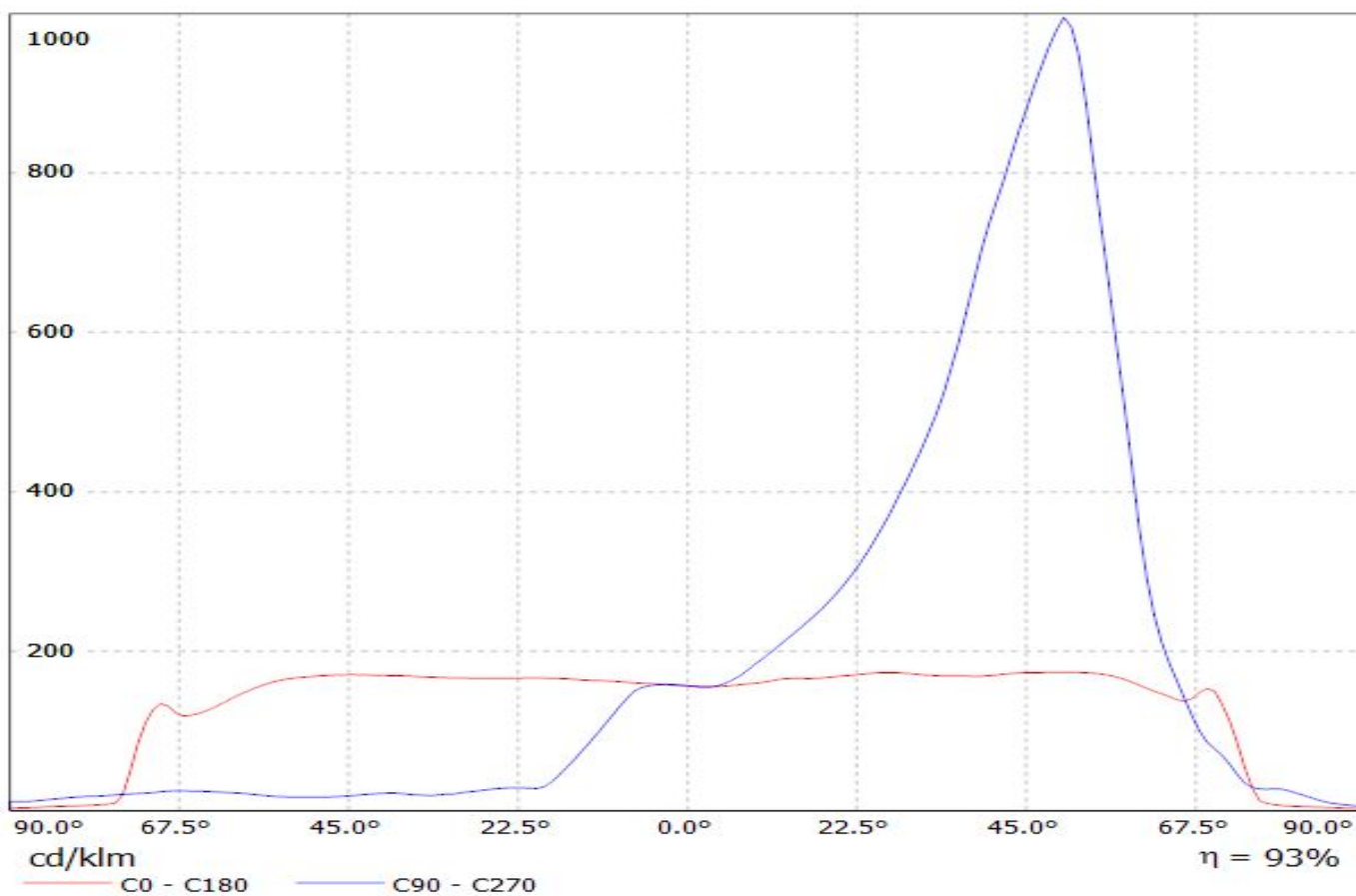

Luminaire: LEDiL Oy CA13758_STRADA-SQ-FS-NP_(PSL445)
Lamps: 1 x Citizen_PSL445_424.116lm@250mA_P=2.81625W_I=0.250A_CCT=2700K

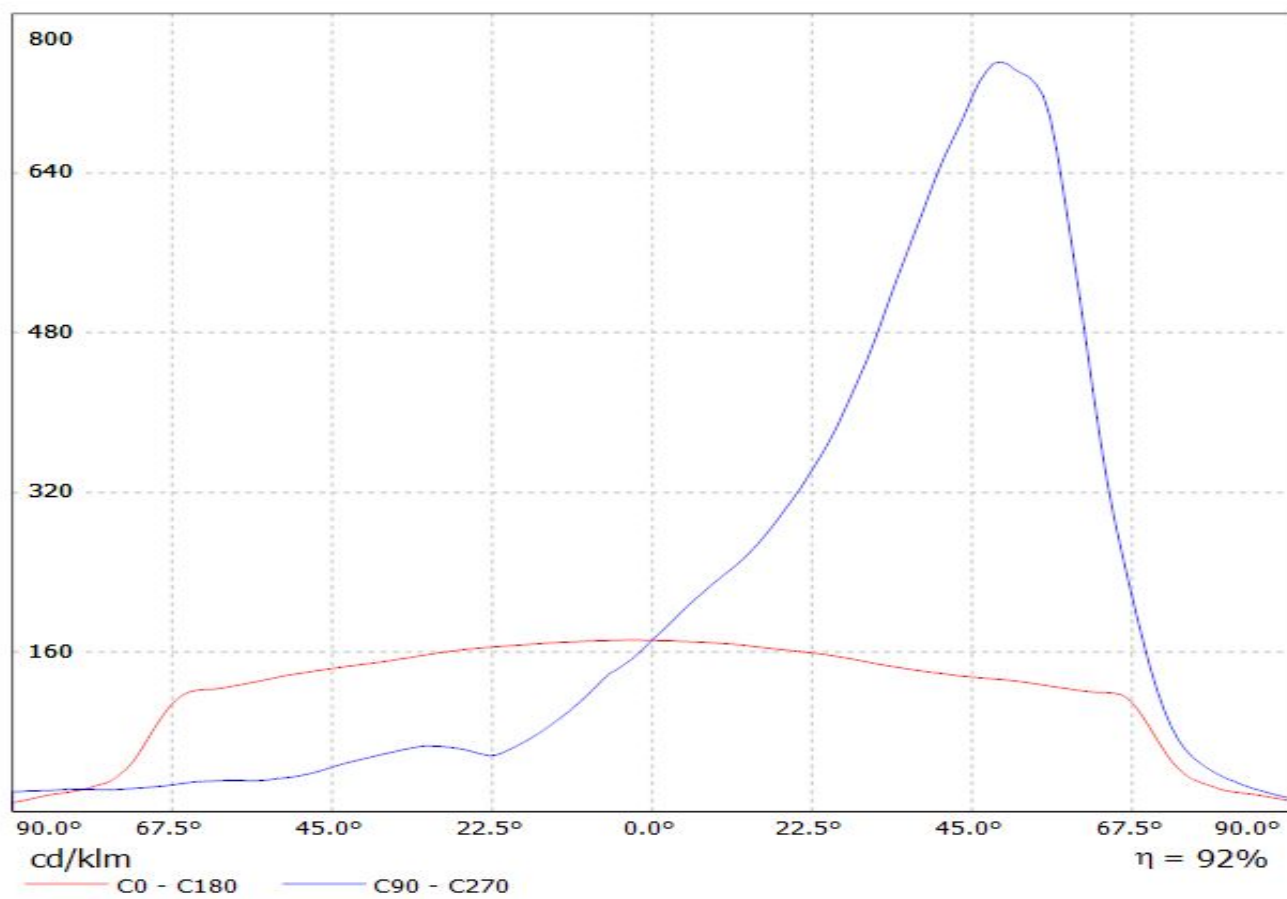

Luminaire: LEDiL Oy CA13758_STRADA-SQ-FS-NP_(MK-R)
Lamps: 1 x CREE_MK-R_358.348lm@250mA_P=2.84311W_I=249.9mA

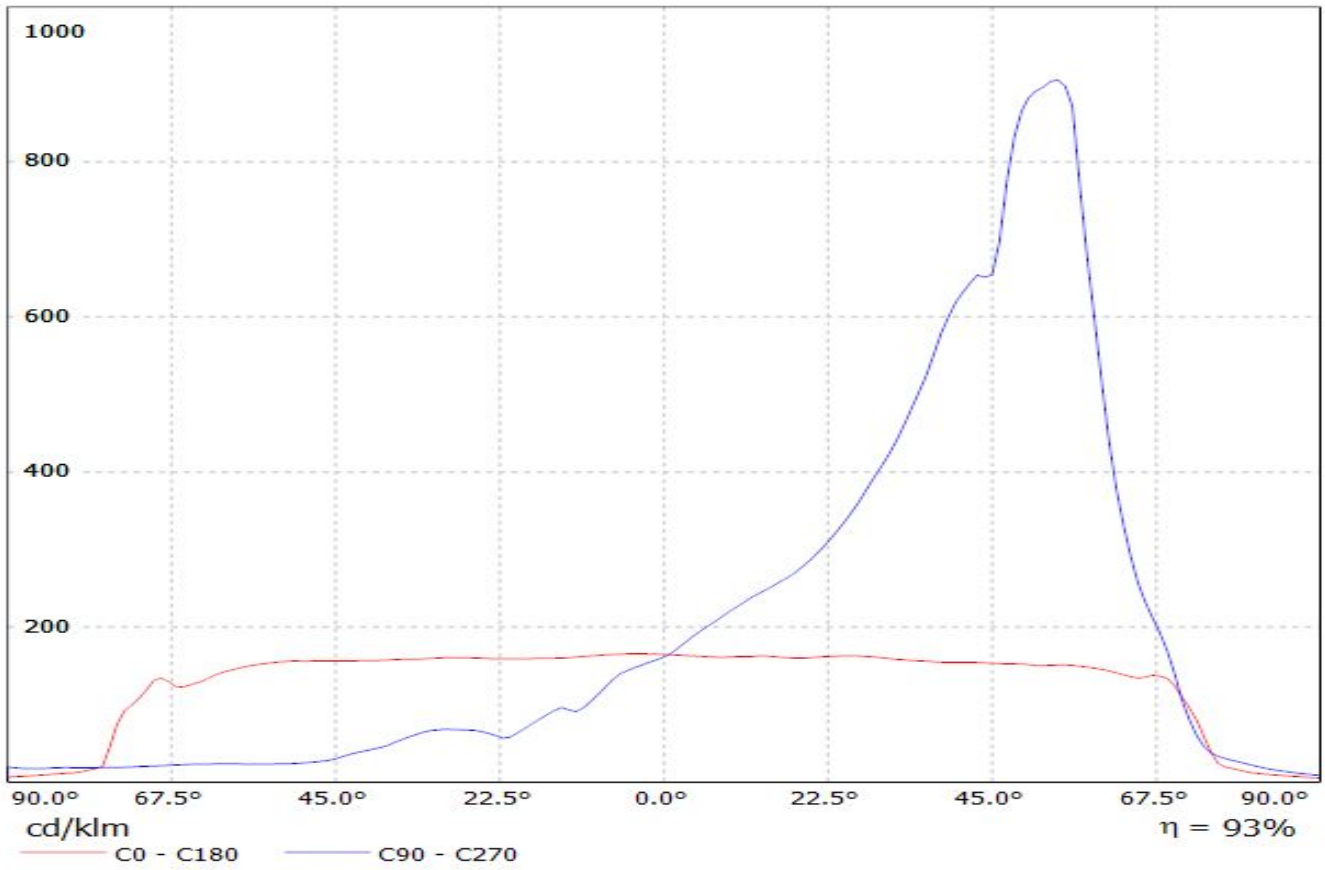

Luminaire: LEDiL Oy CA13758_STRADA-SQ-FS-NP_(XM-L) Eff.93.1%
Lamps: 1 x CREE_XM-L_(XMLAWT-00-0000-0000T6051)_100.386lm@259mA_P=0.724735W_I=249.9mA

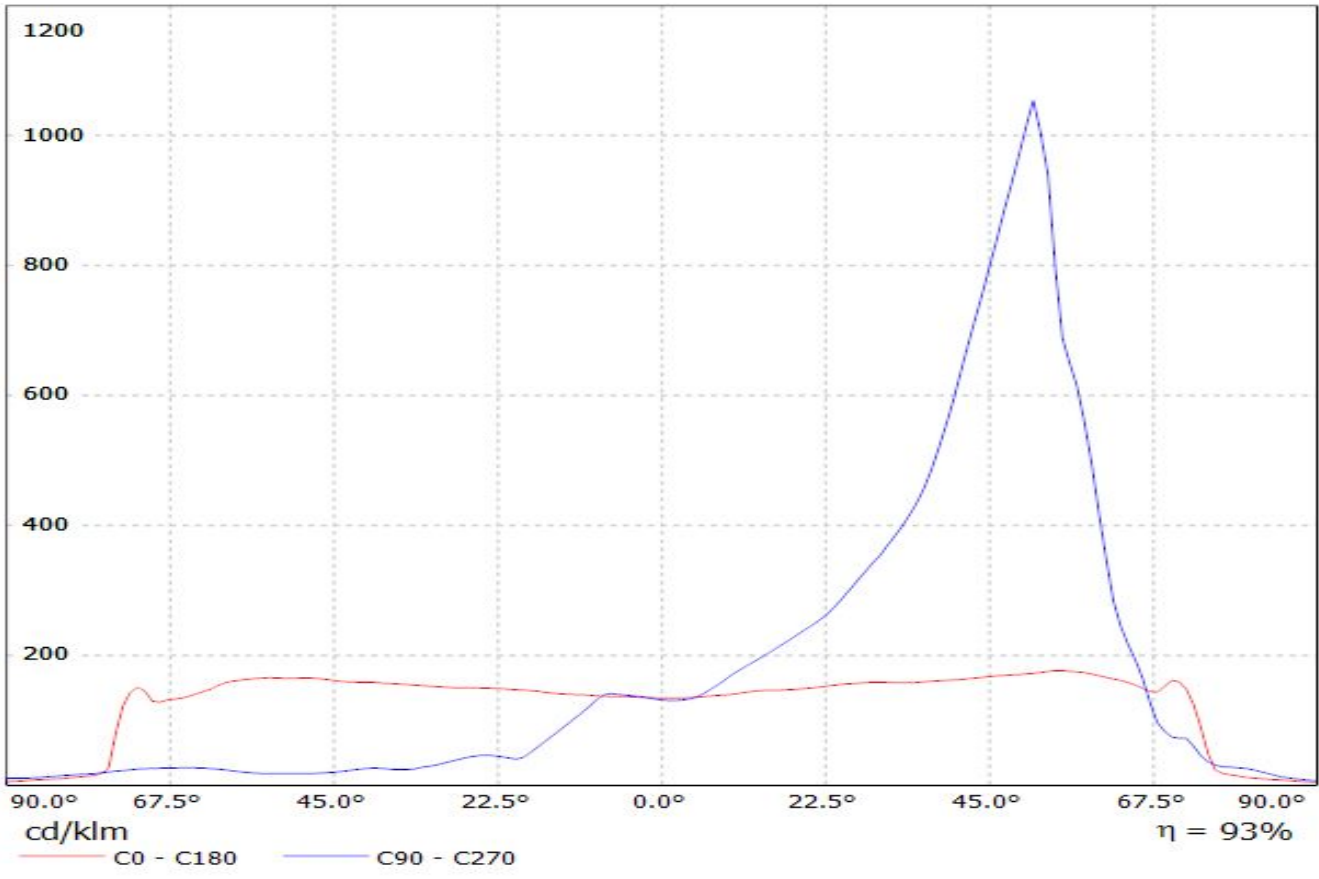

Luminaire: LEDiL Oy CA13758_STRADA-SQ-FS-NP_(XT-E) Eff.93.0%
Lamps: 1 x CREE_XT-E_(XTEAWT-00-0000-00000HBE8)_73.2149lm@250mA_P=0.779476W_I=249.9mA

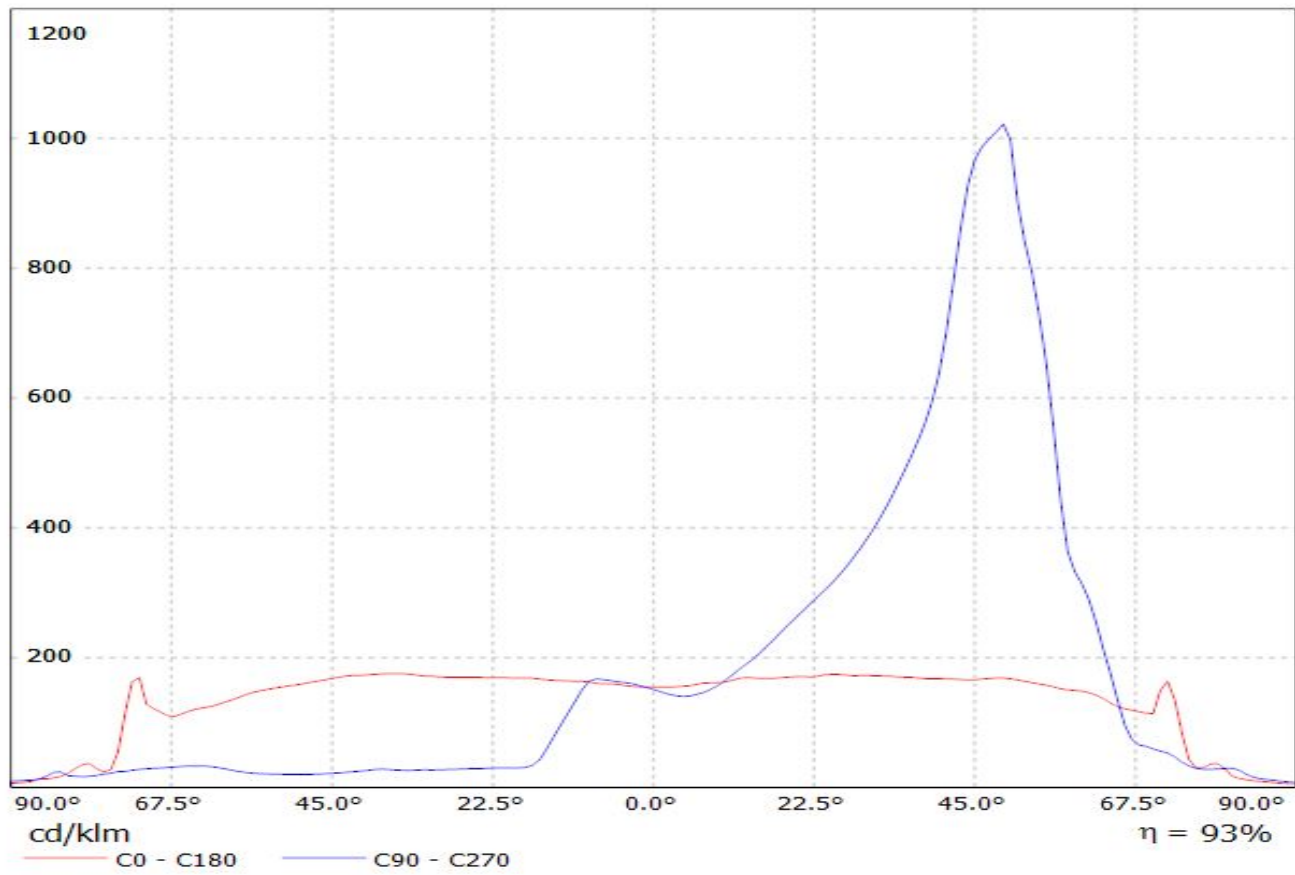

Luminaire: LEDiL Oy CA13758_STRADA-SQ-FS-NP_(XP-L)
Lamps: 1 x Cree_XP-L_125.584lm@250mA_P=0.738255W_I=249.9mA

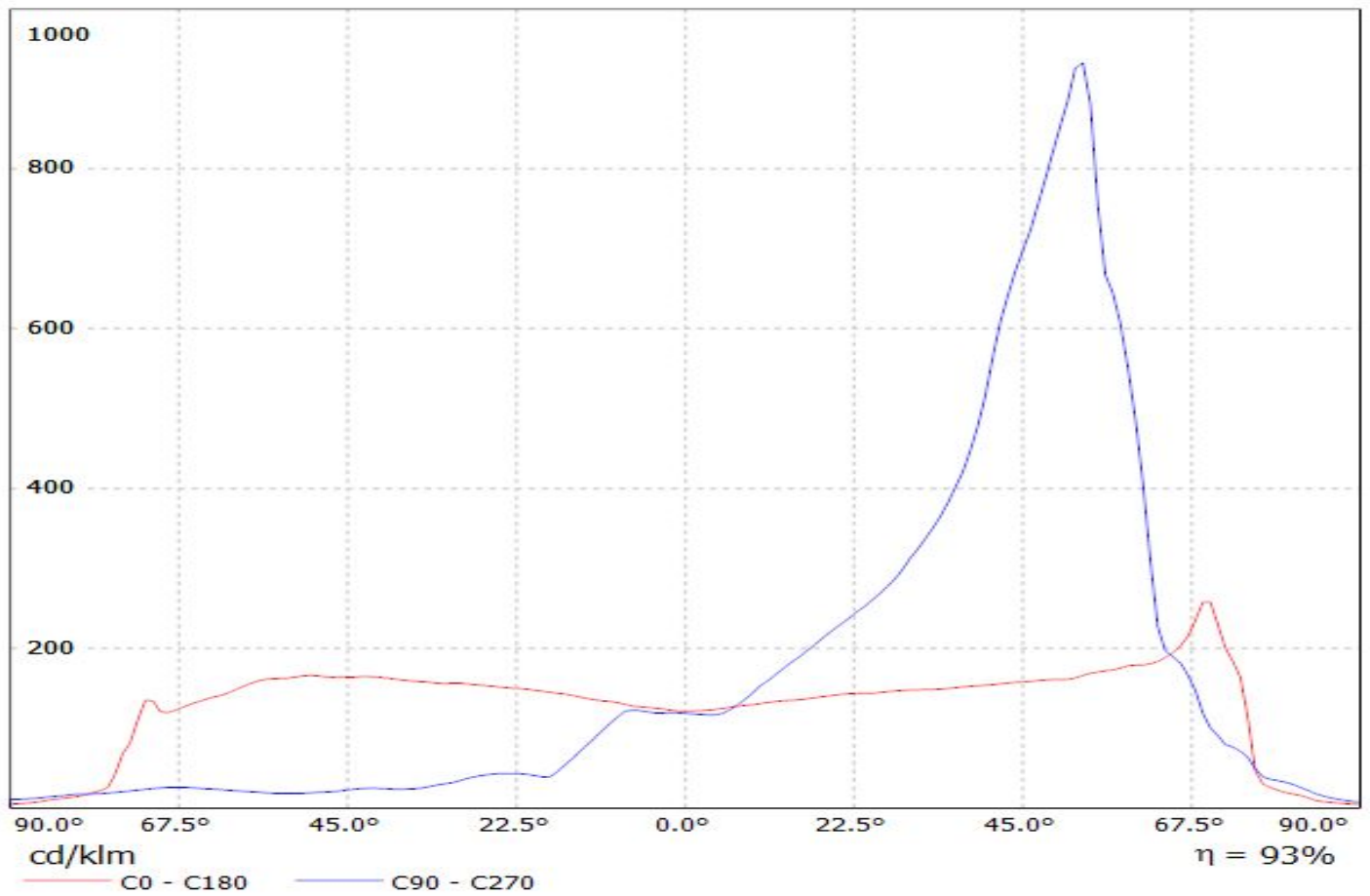

Luminaire: LEDiL Oy CA13758_STRADA-SQ-FS-NP_(Cree_XHP50_cool_white)
Lamps: 1 x Cree_XHP50_cool_white_243.713lm@250mA_P=1.42945W_I=0.2499A

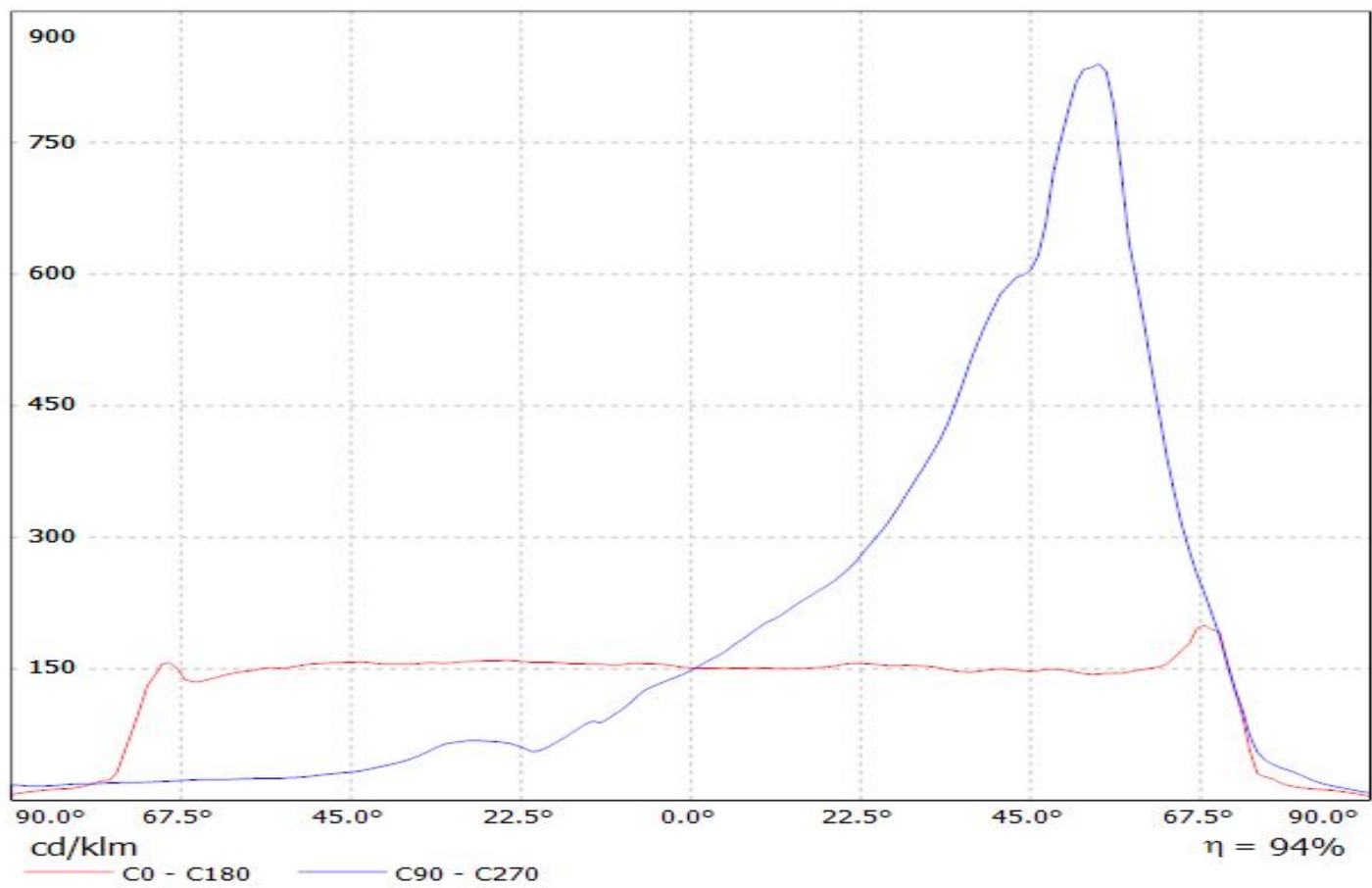

Luminaire: LEDiL Oy CA13758_STRADA-SQ-FS-NP_(XHP70)_glass
Lamps: 1 x Cree_XHP70_glass-chassis_260.488lm@250mA_P=1.38405W_I=0.2499A

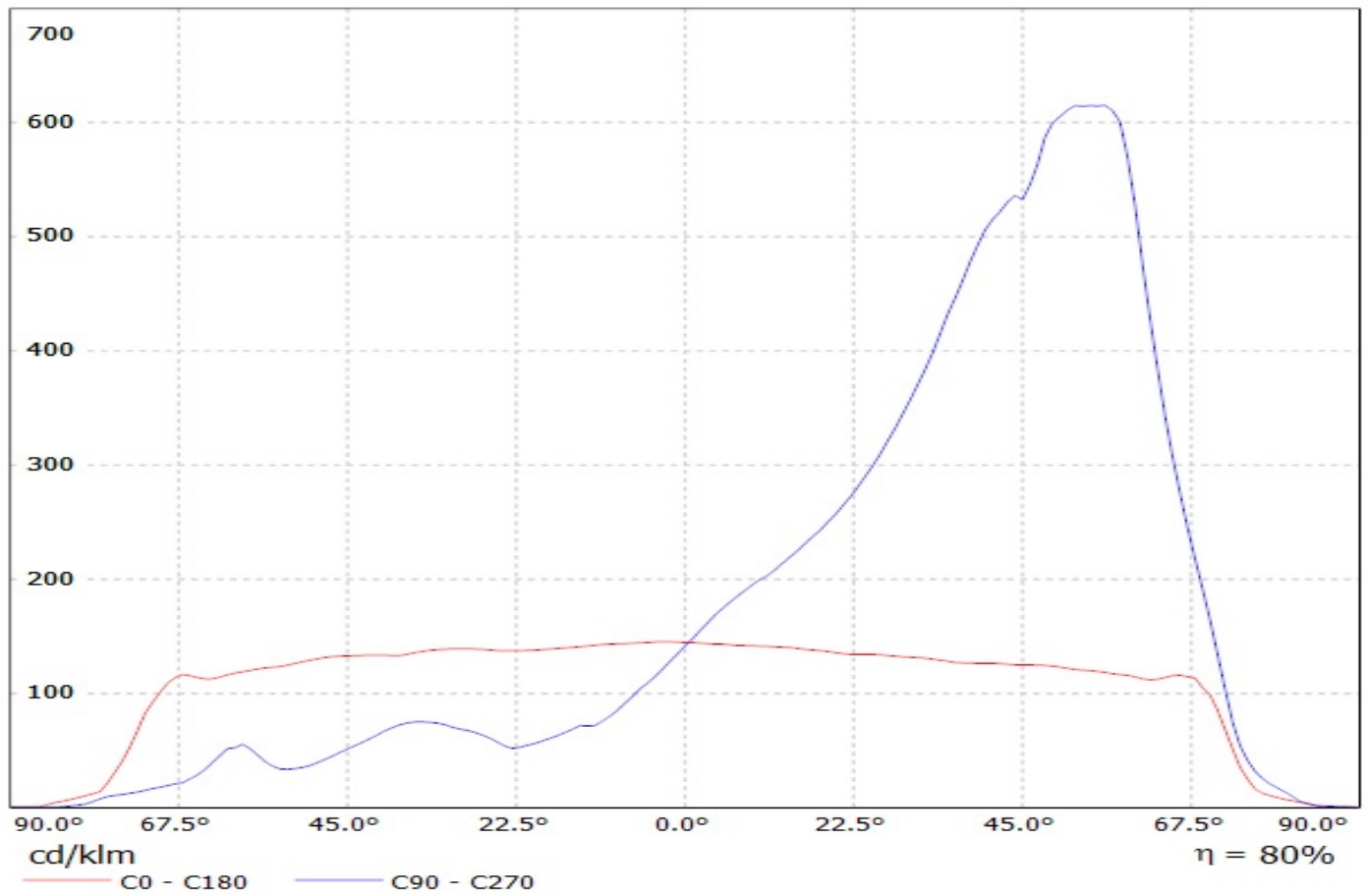

Luminaire: Ledil CA13758_STRADA-SQ-FS-NP_(XP-L2)

Lamps: 1 x Cree_XP-L2_(XPLWT-00-0000-000HU630G)_115.868lm@250mA_P=0.717875W_I=0.25A

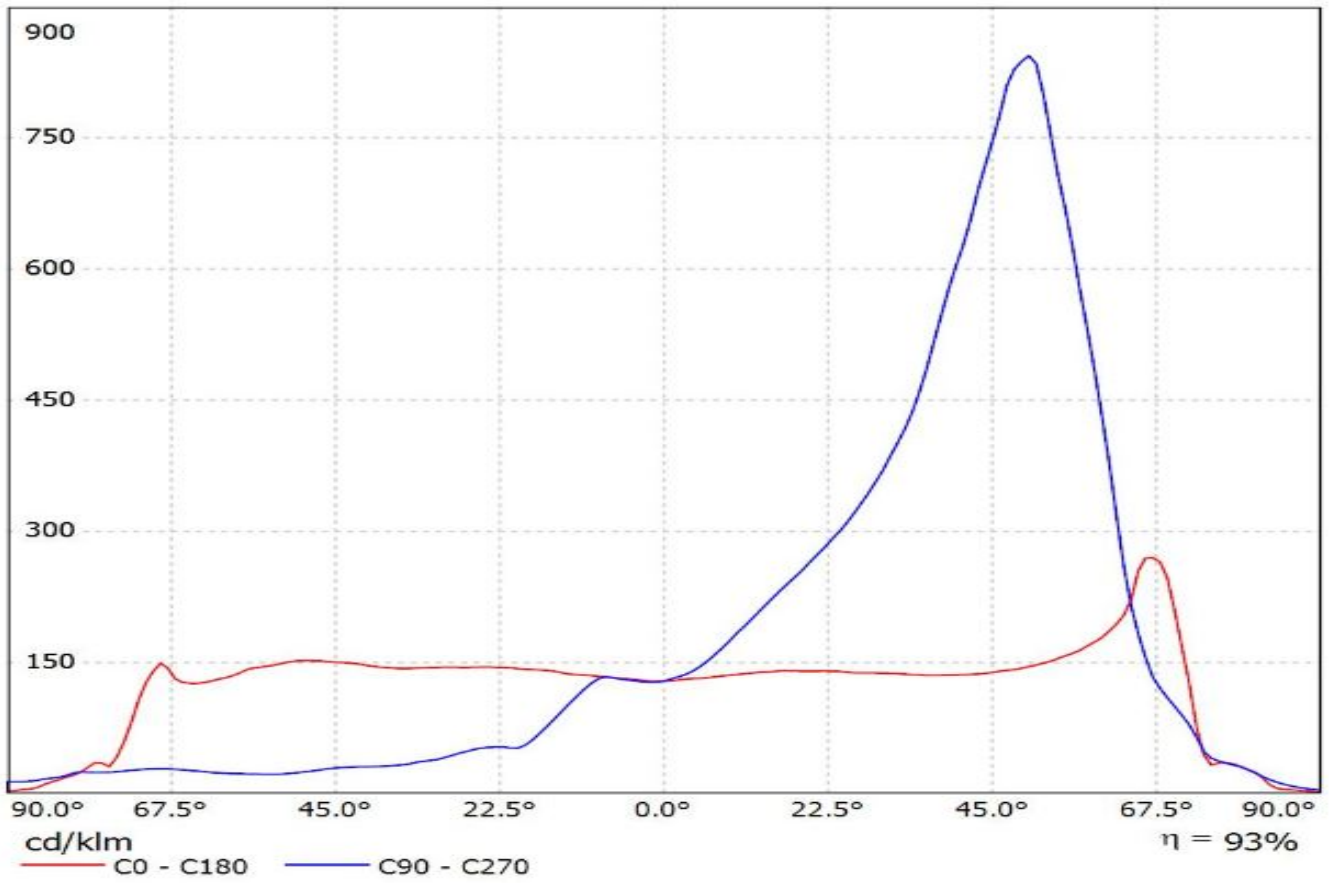

Luminaire: LEDiL Oy CA13758_STRADA-SQ-FS-NP_(LUXEON_M) Eff.92.4%
Lamps: 1 x LUXEON_M_349.54lm@250mA_CCT=4092K_P=2.72807W_I=249.8mA

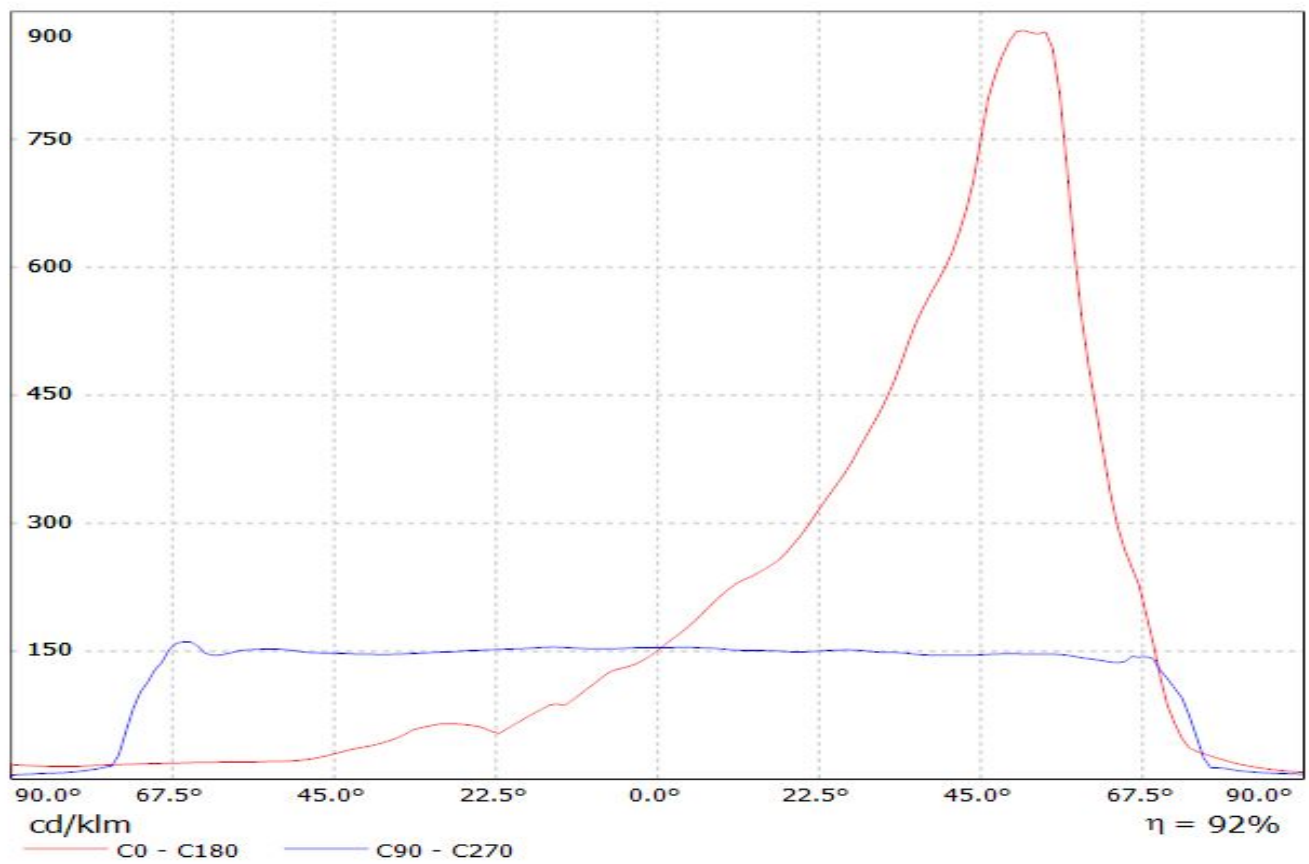

Luminaire: LEDiL Oy CA13758_STRADA-SQ-FS-NP_(Luxeon_MZ) Eff: 93%
Lamps: 1 x Luxeon_MZ_389.815lm@250mA_CCT=3800K_P=2.77989W_I=249.9mA

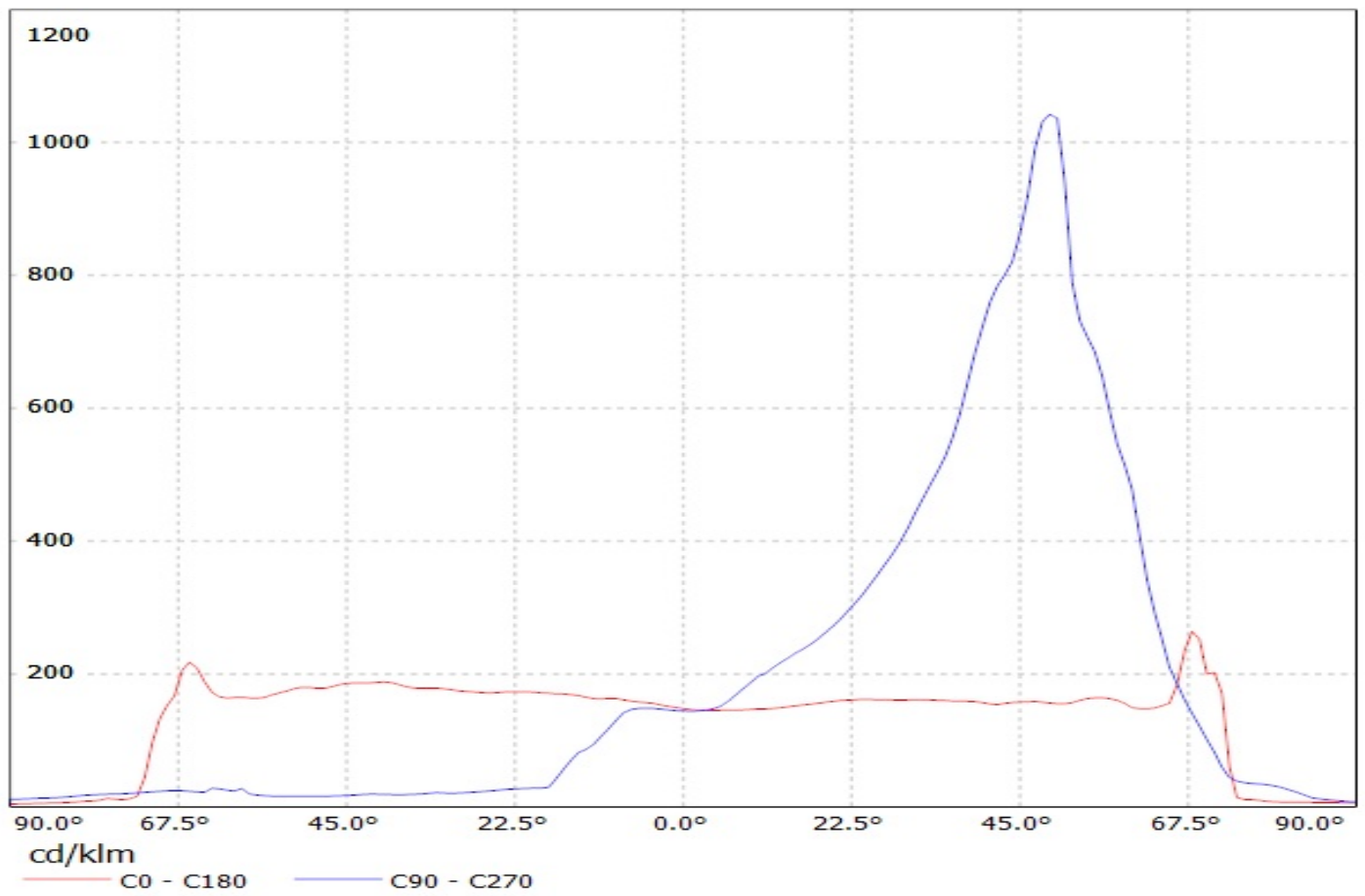

Luminaire: Ledil CA13758_STRADA-SQ-FS-NP_(LUXEON_XR-M_Linear_1x4)
Lamps: 1 x Lumiled_LUXEON_XR-M_Linear_1x4_1798.32lm@250mA_P=11.005W_I=0.25A

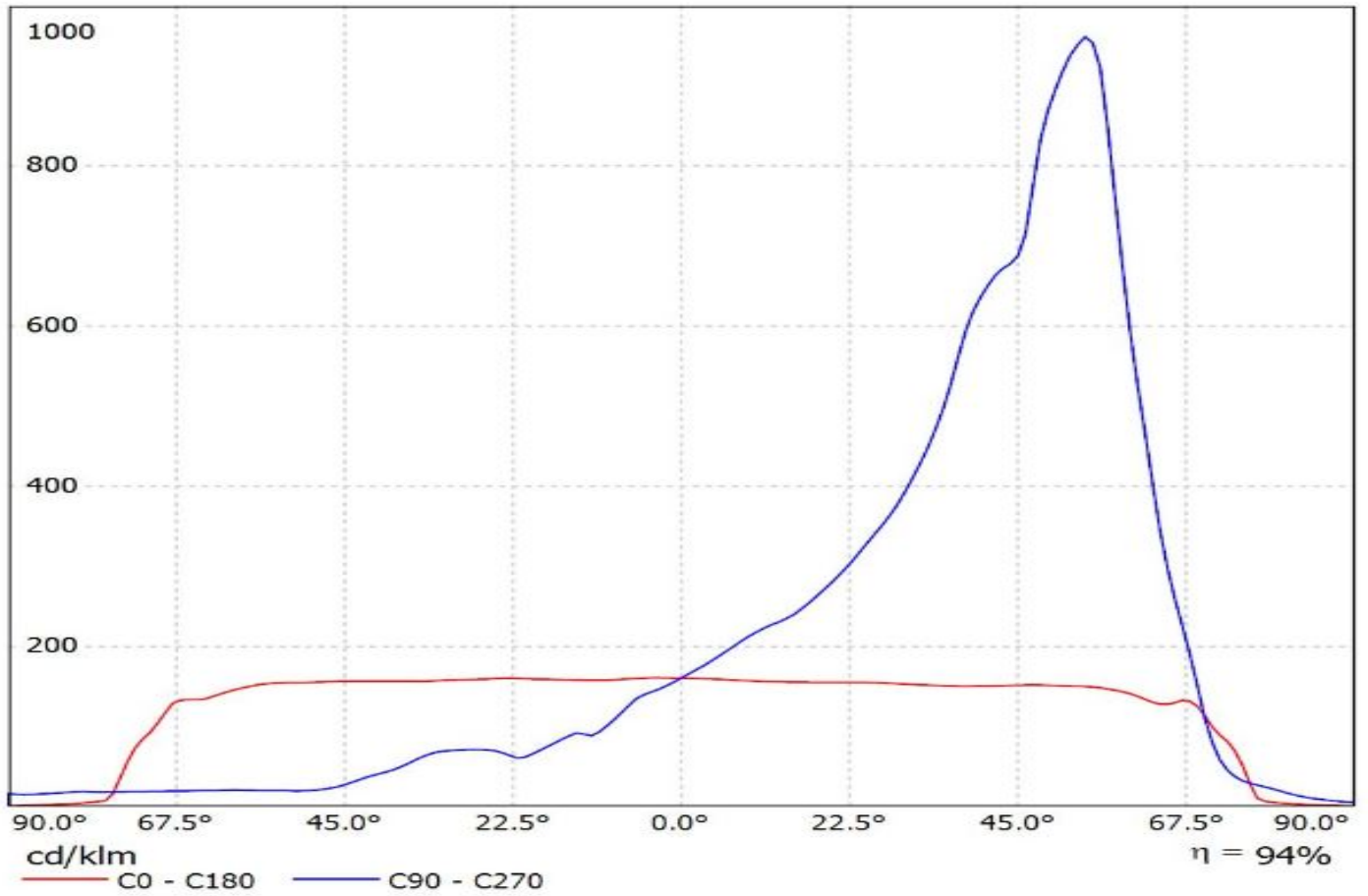

Luminaire: Ledil CA13758_STRADA-SQ-FS-NP_(Duris_S10)

Lamps: 1 x Osram_Duris_S10_(GW-P7LP32.EM)_999.98lm@250mA_P=9.2345W_I=0.25A

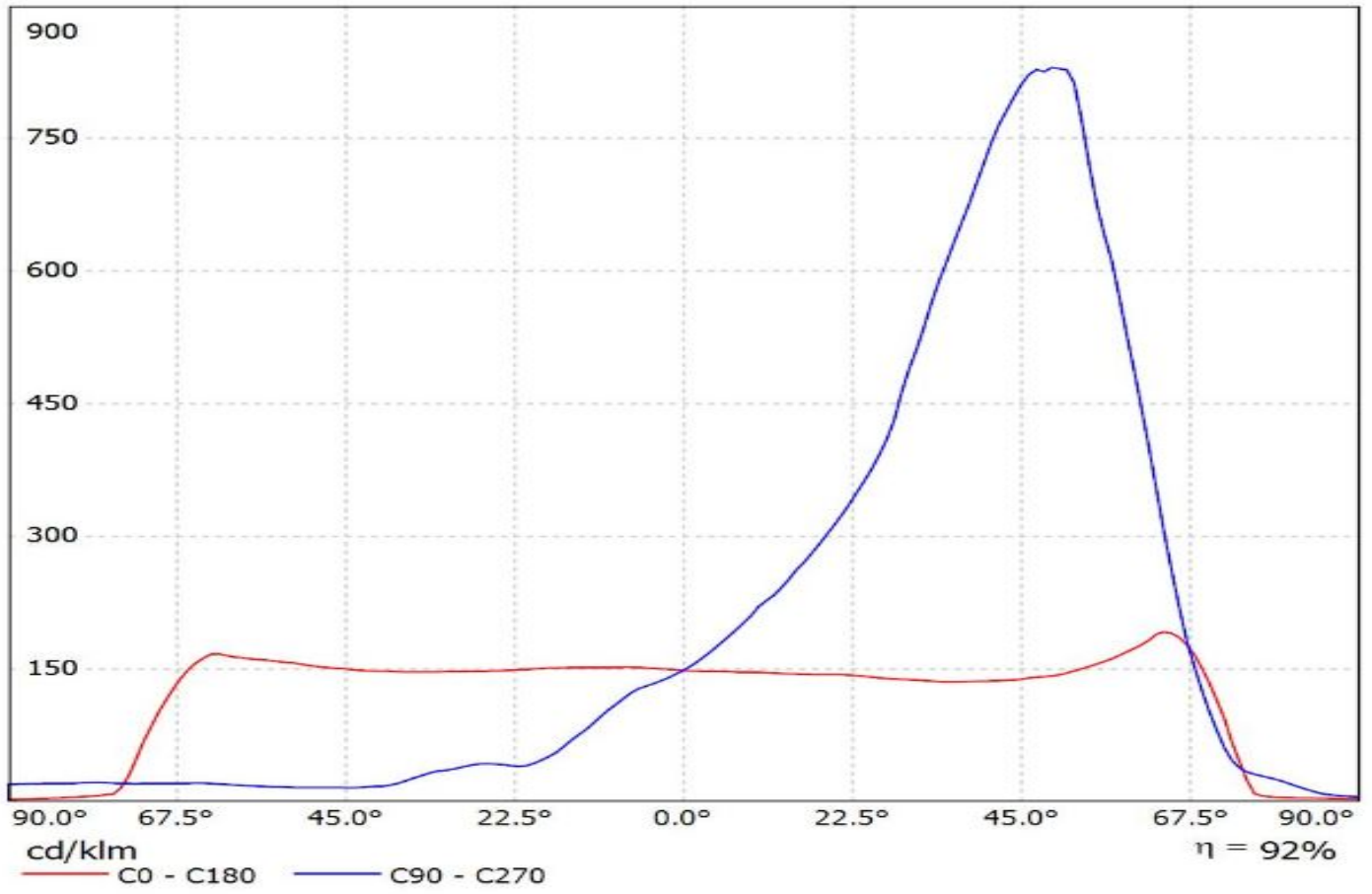

Luminaire: LEDiL Oy CA13758_STRADA-SQ-FS-NP_(PSL440)
Lamps: 1 x Citizen_PSL440_256.951lm@250mA_P=2.8697W_I=0.250A

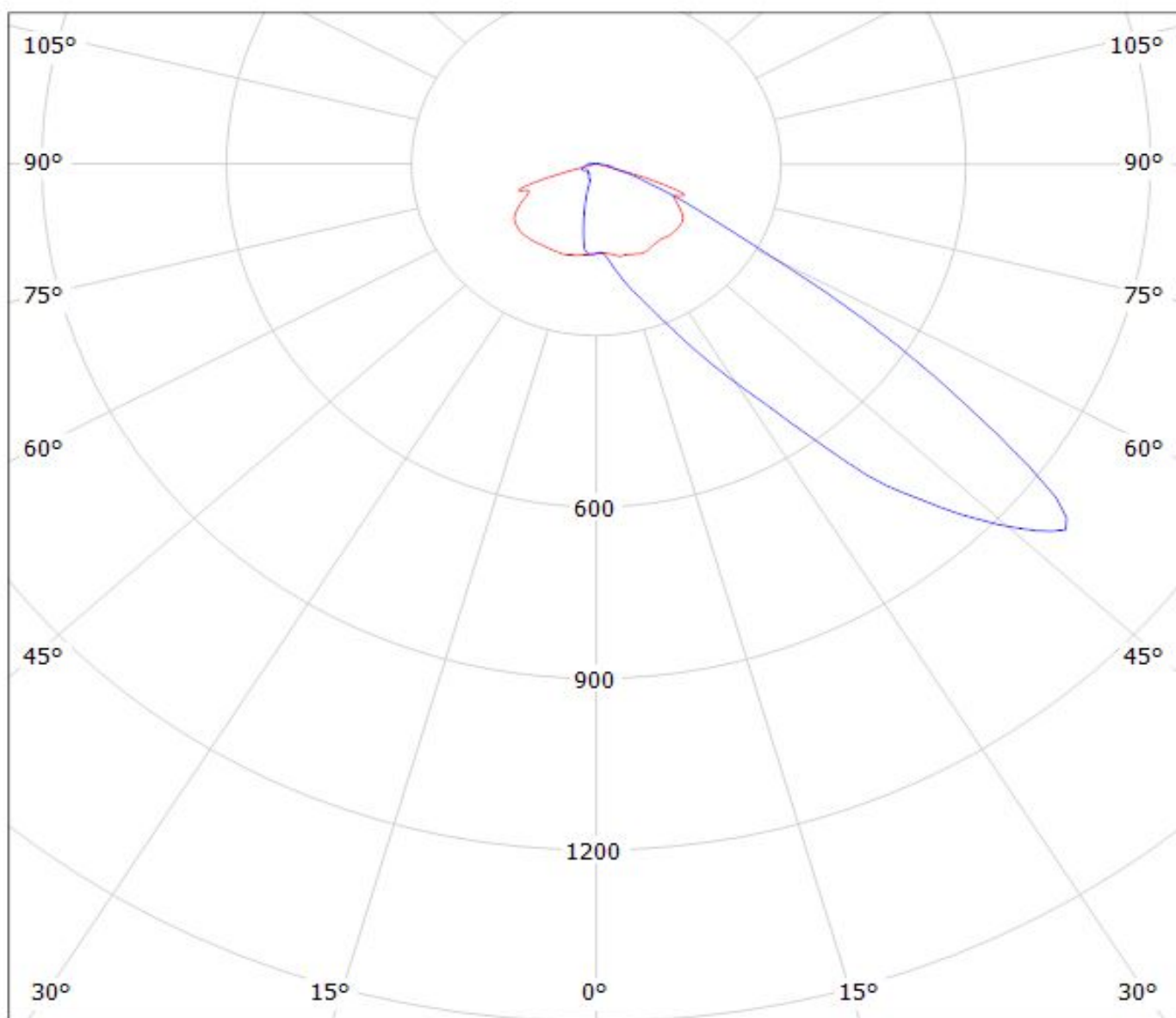

cd/klm

— C0 - C180 — C90 - C270

$\eta = 93\%$

Luminaire: LEDiL Oy CA13758_STRADA-SQ-FS-NP_(PSL445)
Lamps: 1 x Citizen_PSL445_424.116lm@250mA_P=2.81625W_I=0.250A_CCT=2700K

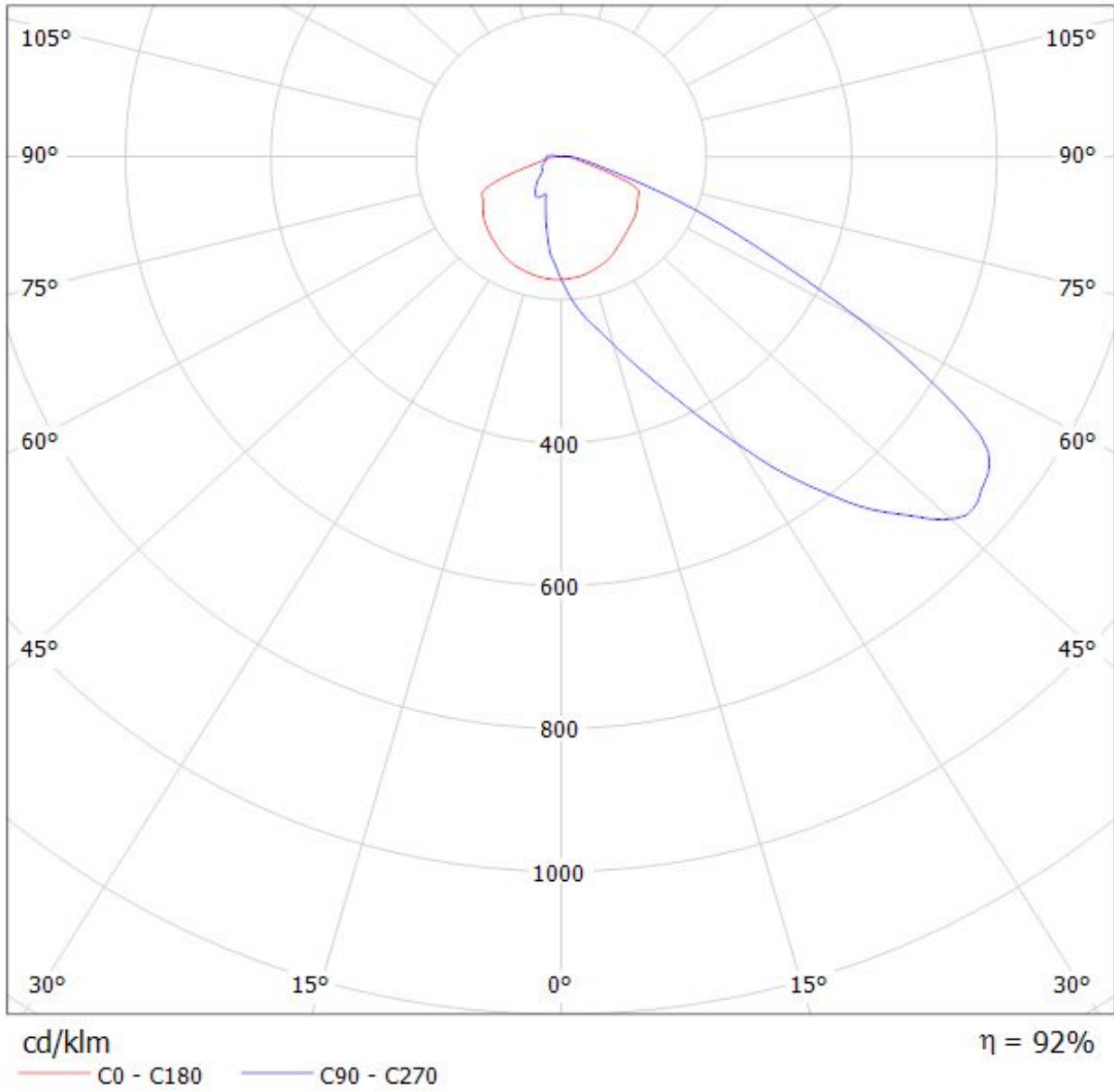

Luminaire: LEDiL Oy CA13758_STRADA-SQ-FS-NP_(MK-R)
Lamps: 1 x CREE_MK-R_358.348lm@250mA_P=2.84311W_I=249.9mA

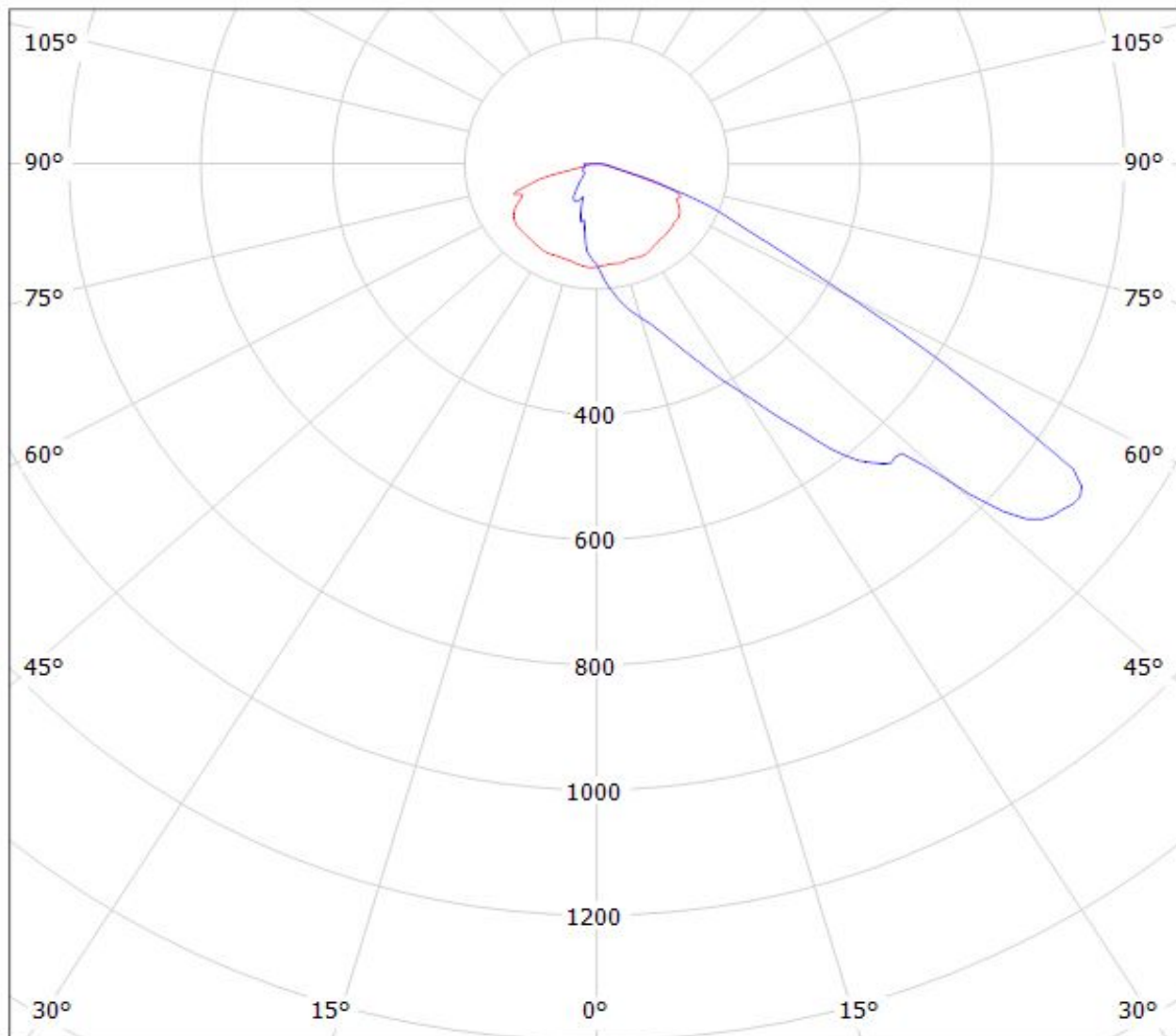

cd/klm

$\eta = 93\%$

— C0 - C180 — C90 - C270

Luminaire: LEDiL Oy CA13758_STRADA-SQ-FS-NP_(XM-L) Eff.93.1%

Lamps: 1 x CREE_XM-L_(XMLAWT-00-0000-0000T6051)_100.386lm@259mA_P=0.724735W_I=249.9mA

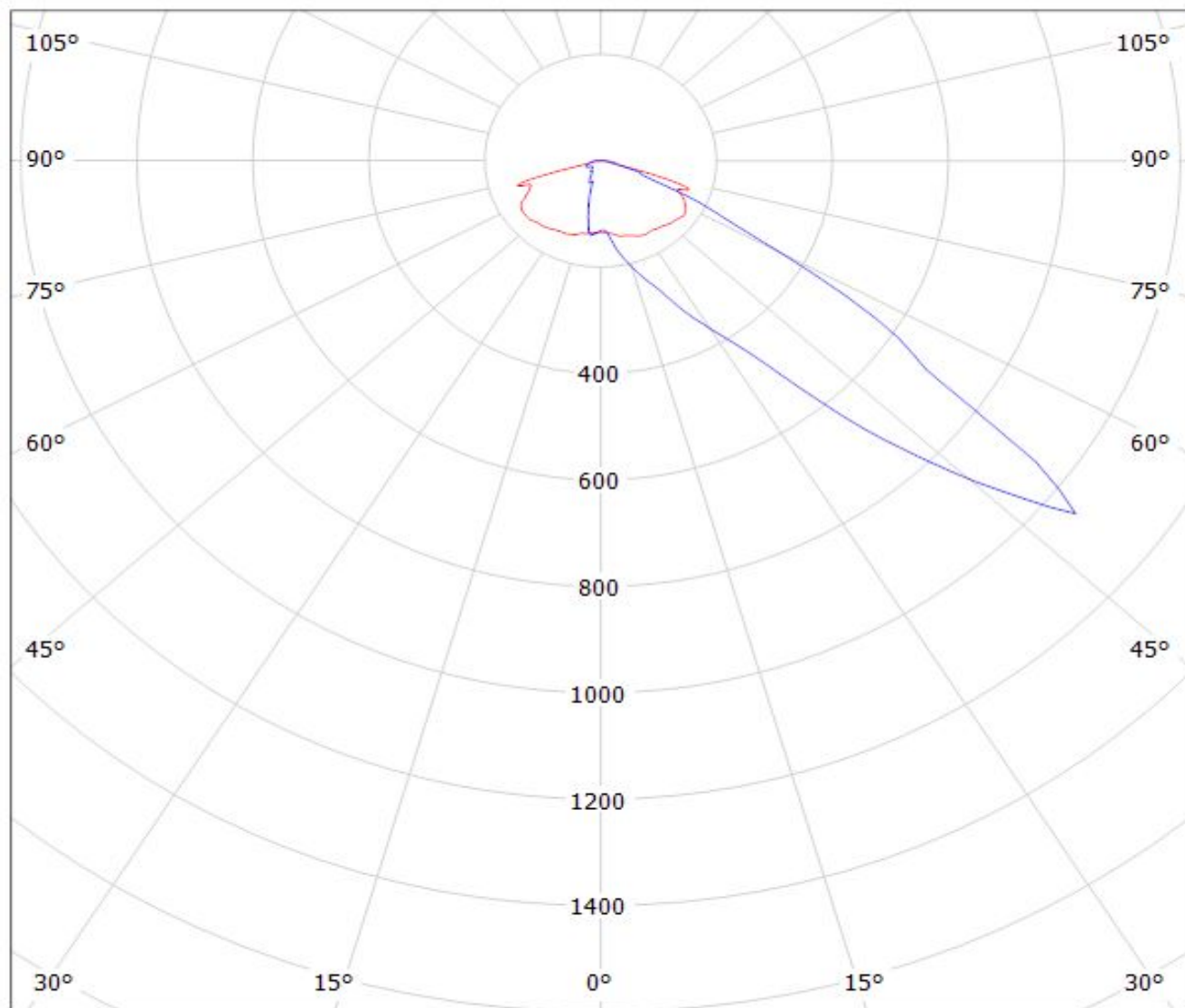

cd/klm

$\eta = 93\%$

— C0 - C180 — C90 - C270

Luminaire: LEDiL Oy CA13758_STRADA-SQ-FS-NP_(XT-E) Eff.93.0%

Lamps: 1 x CREE_XT-E_(XTEAWT-00-0000-00000HBE8)_73.2149lm@250mA_P=0.779476W_I=249.9mA

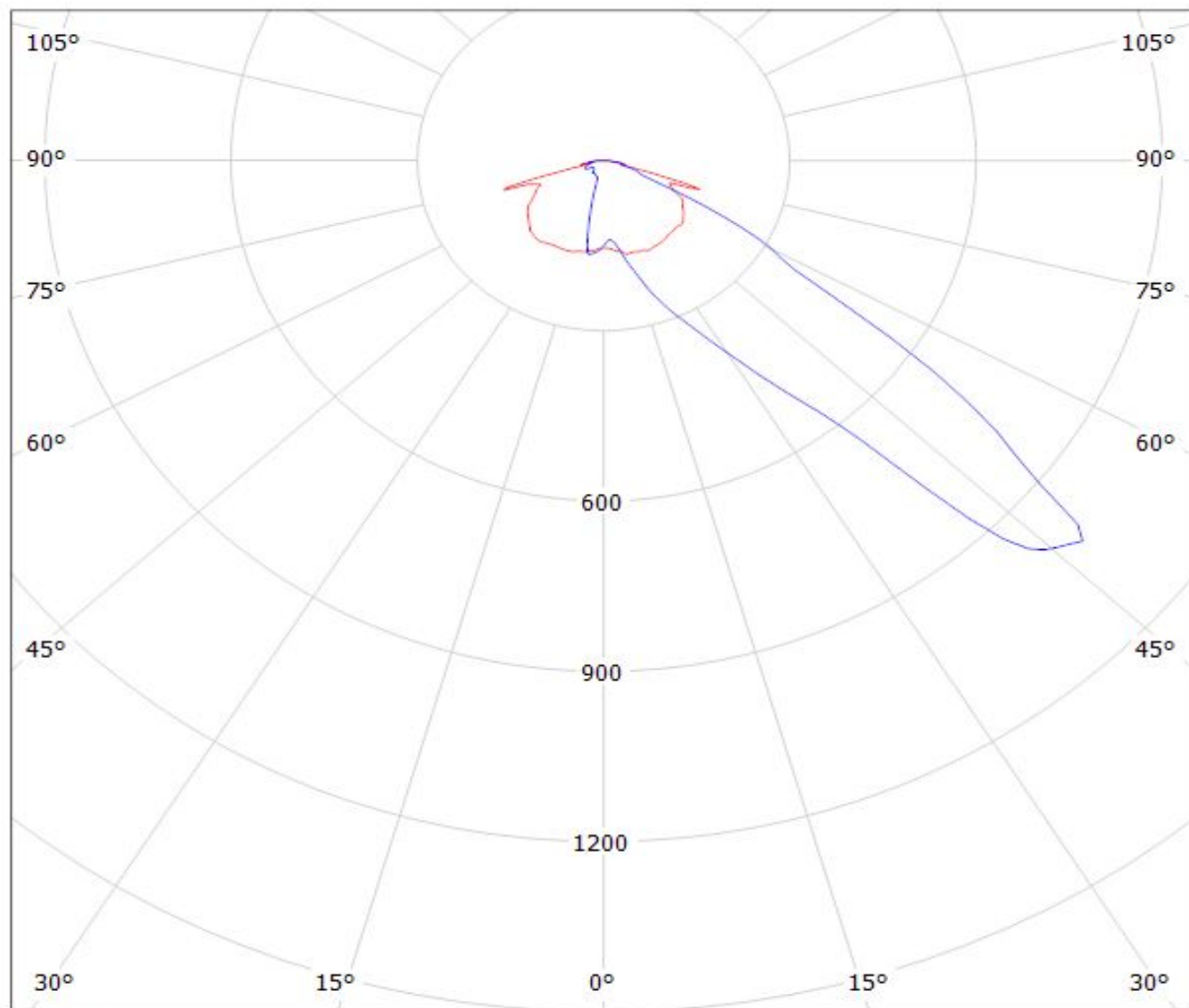

cd/klm

— C0 - C180

— C90 - C270

$\eta = 93\%$

Luminaire: LEDiL Oy CA13758_STRADA-SQ-FS-NP_(XP-L)
Lamps: 1 x Cree_XP-L_125.584lm@250mA_P=0.738255W_I=249.9mA

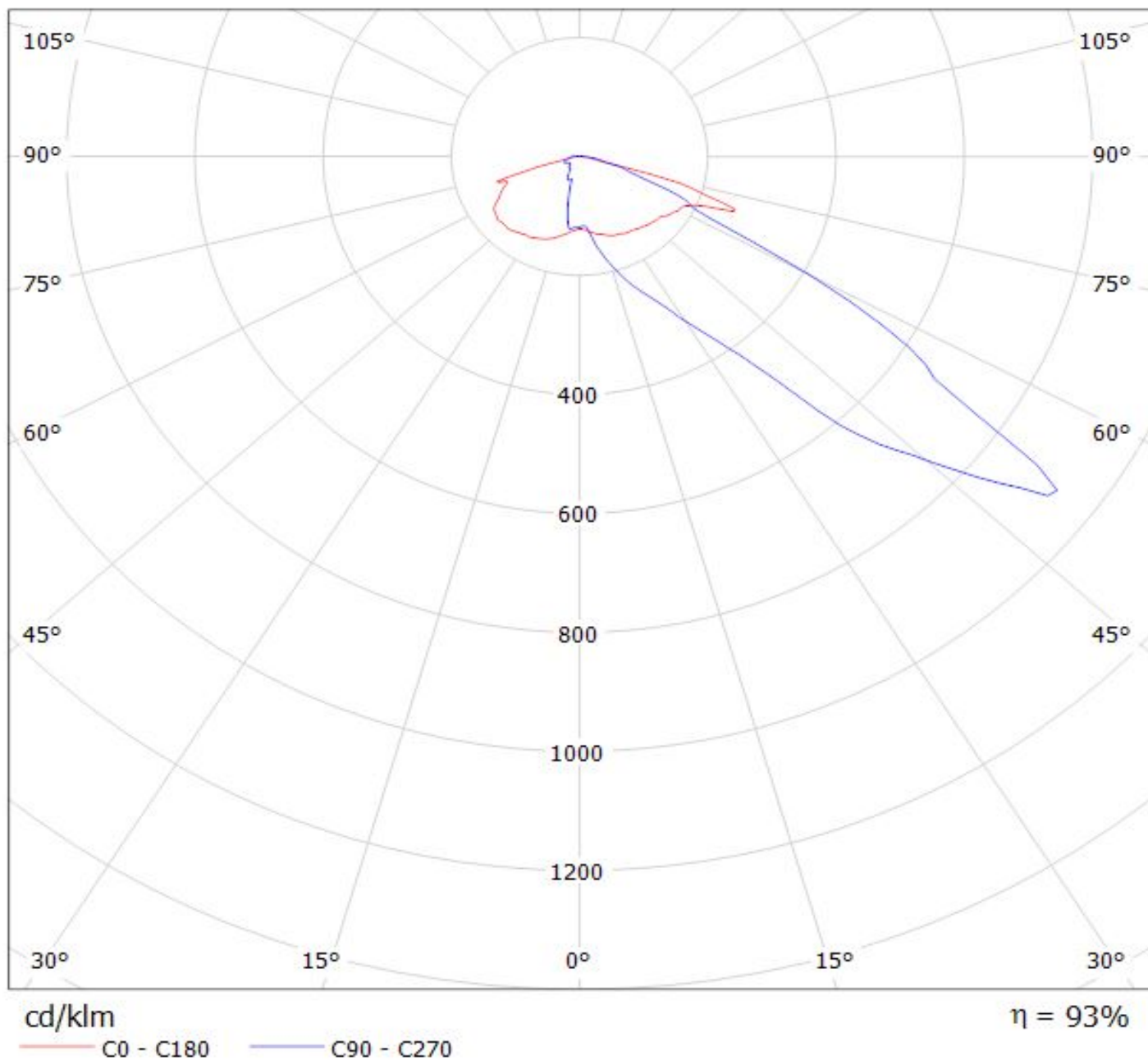

Luminaire: LEDiL Oy CA13758_STRADA-SQ-FS-NP_(Cree_XHP50_cool_white)
Lamps: 1 x Cree_XHP50_cool_white_243.713lm@250mA_P=1.42945W_I=0.2499A

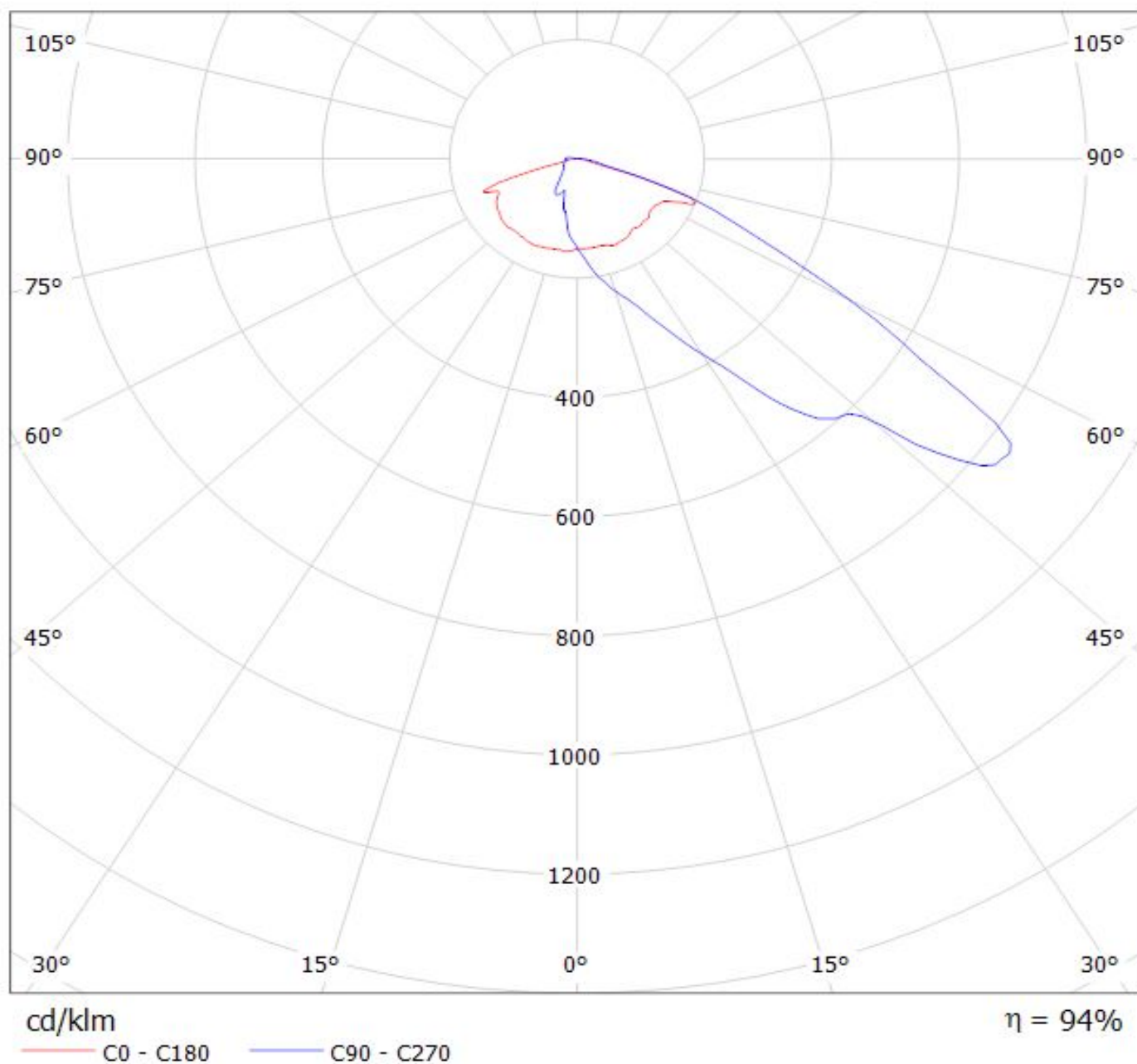

Luminaire: LEDiL Oy CA13758_STRADA-SQ-FS-NP_(XHP70)_glass

Lamps: 1 x Cree_XHP70_glass-chassis_260.488lm@250mA_P=1.38405W_I=0.2499A

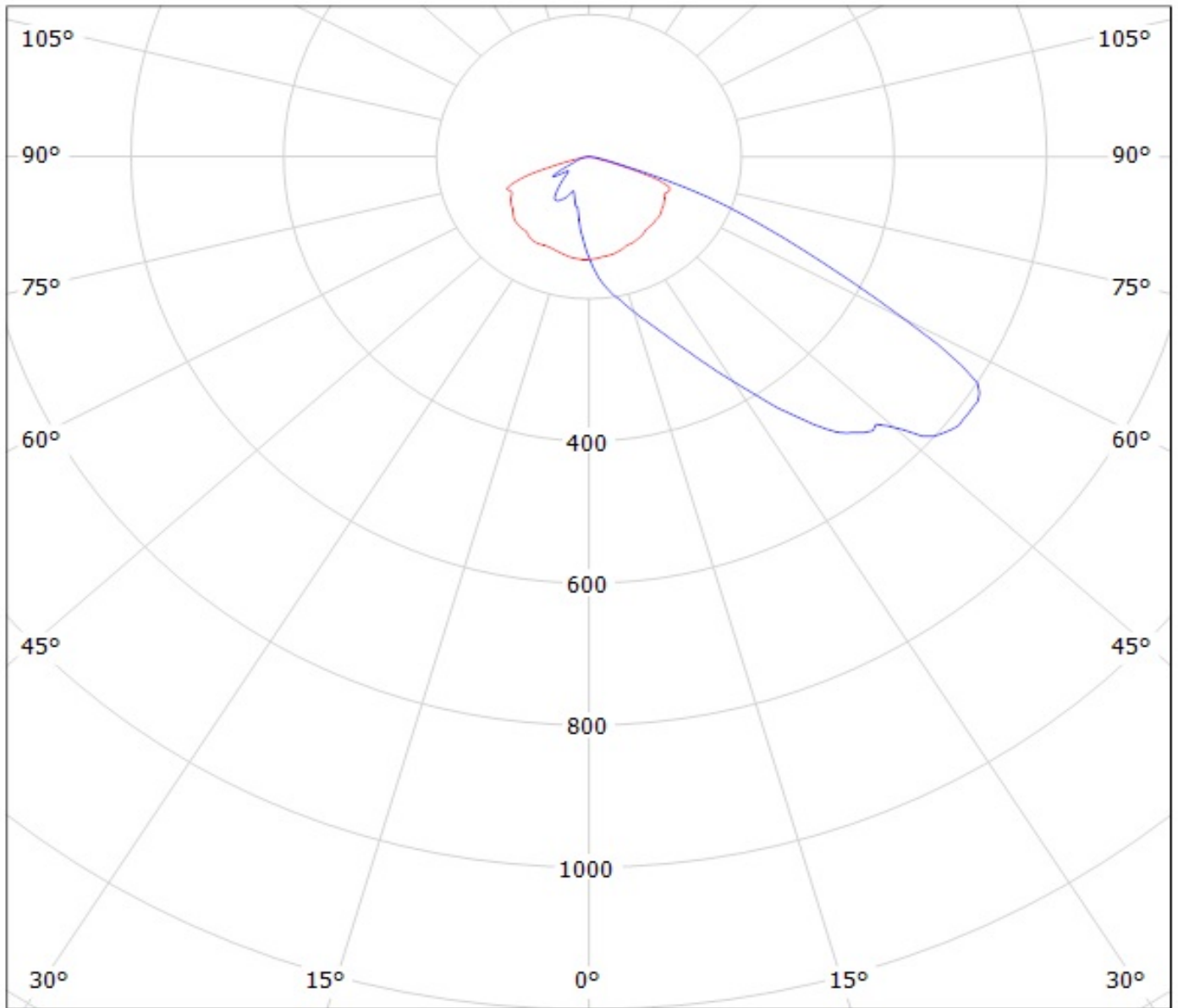

cd/klm

$\eta = 80\%$

— C0 - C180

— C90 - C270

Luminaire: Ledil CA13758_STRADA-SQ-FS-NP_(XP-L2)

Lamps: 1 x Cree_XP-L2_(XPLWT-00-0000-000HU630G)_115.868lm@250mA_P=0.717875W_I=0.25A

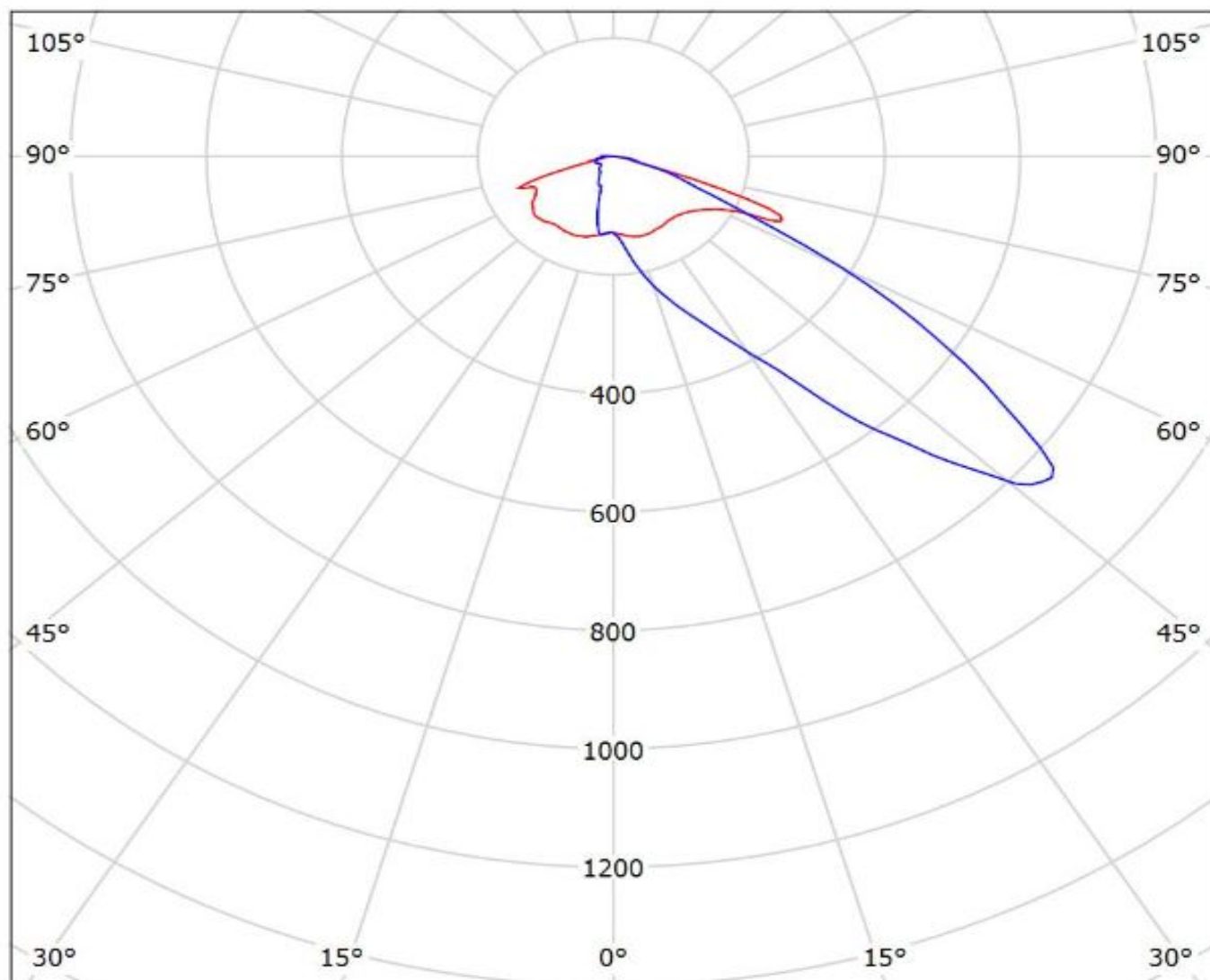

cd/klm

— C0 - C180 — C90 - C270

$\eta = 93\%$

Luminaire: LEDiL Oy CA13758_STRADA-SQ-FS-NP_(LUXEON_M) Eff.92.4%
Lamps: 1 x LUXEON_M_349.54lm@250mA_CCT=4092K_P=2.72807W_I=249.8mA

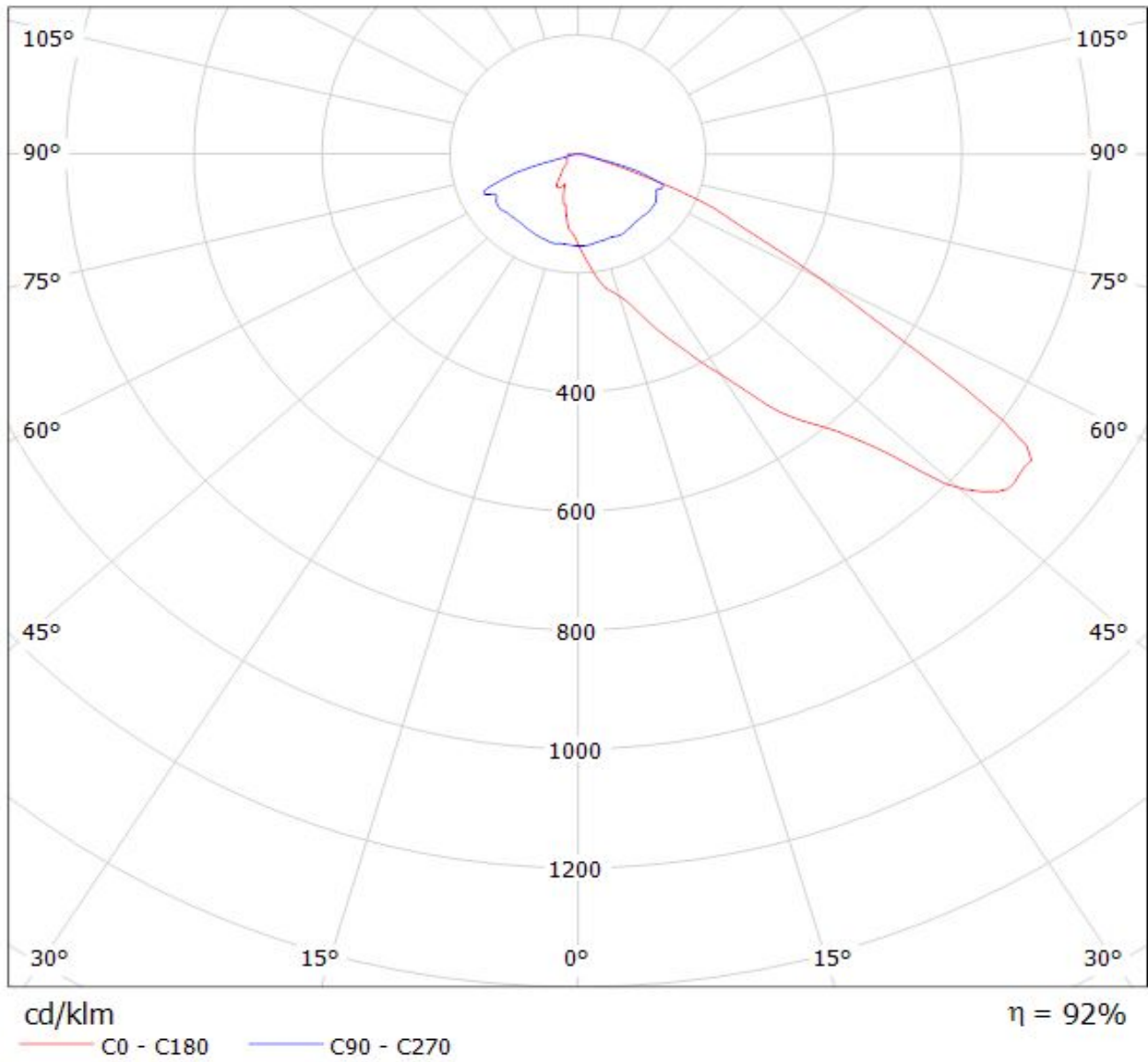

Luminaire: LEDiL Oy CA13758_STRADA-SQ-FS-NP_(Luxeon_MZ) Eff: 93%
Lamps: 1 x Luxeon_MZ_389.815lm@250mA_CCT=3800K_P=2.77989W_I=249.9mA

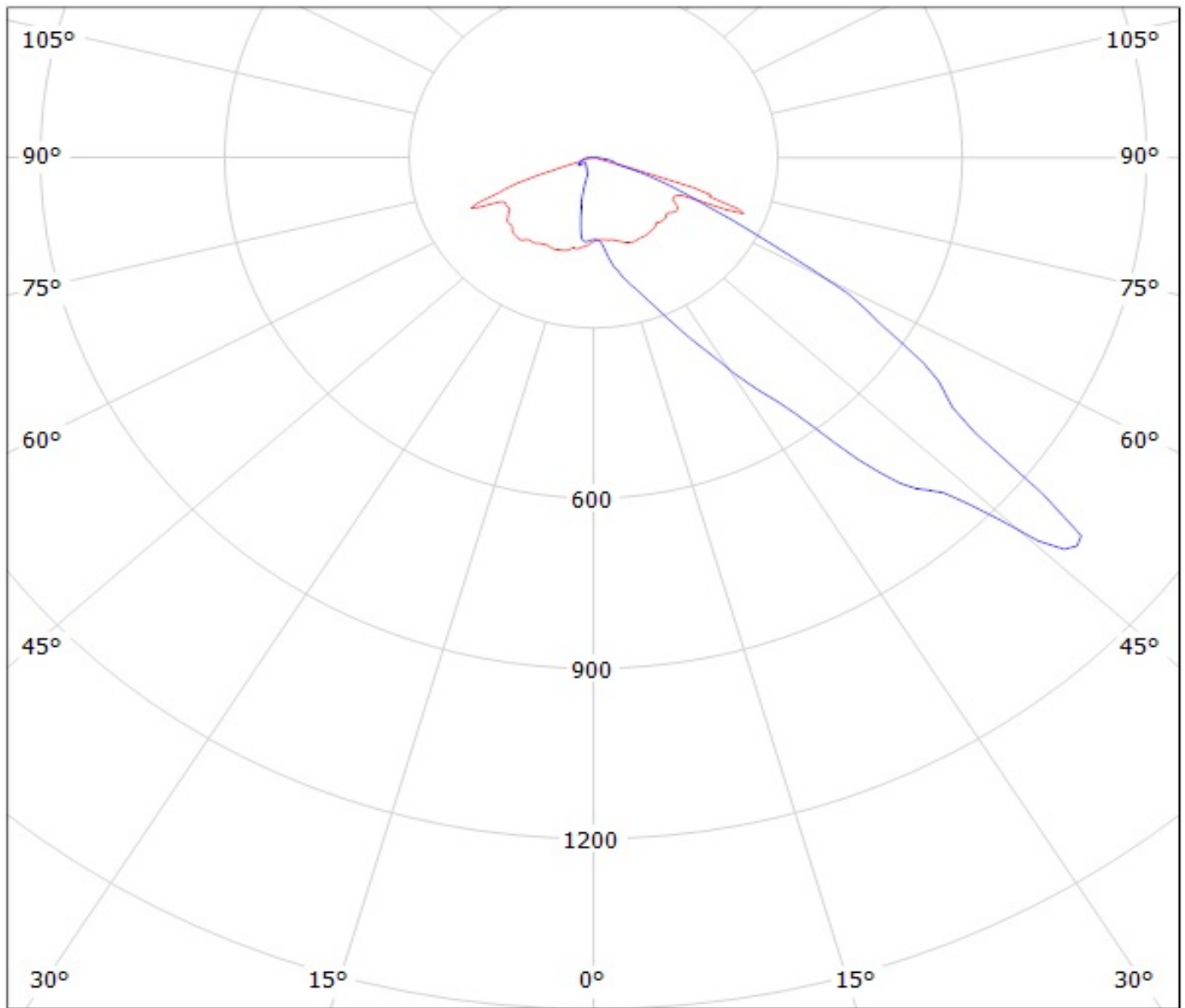

cd/klm

— C0 - C180 — C90 - C270

Luminaire: Ledil CA13758_STRADA-SQ-FS-NP_(LUXEON_XR-M_Linear_1x4)

Lamps: 1 x Lumiled_LUXEON_XR-M_Linear_1x4_1798.32lm@250mA_P=11.005W_I=0.25A

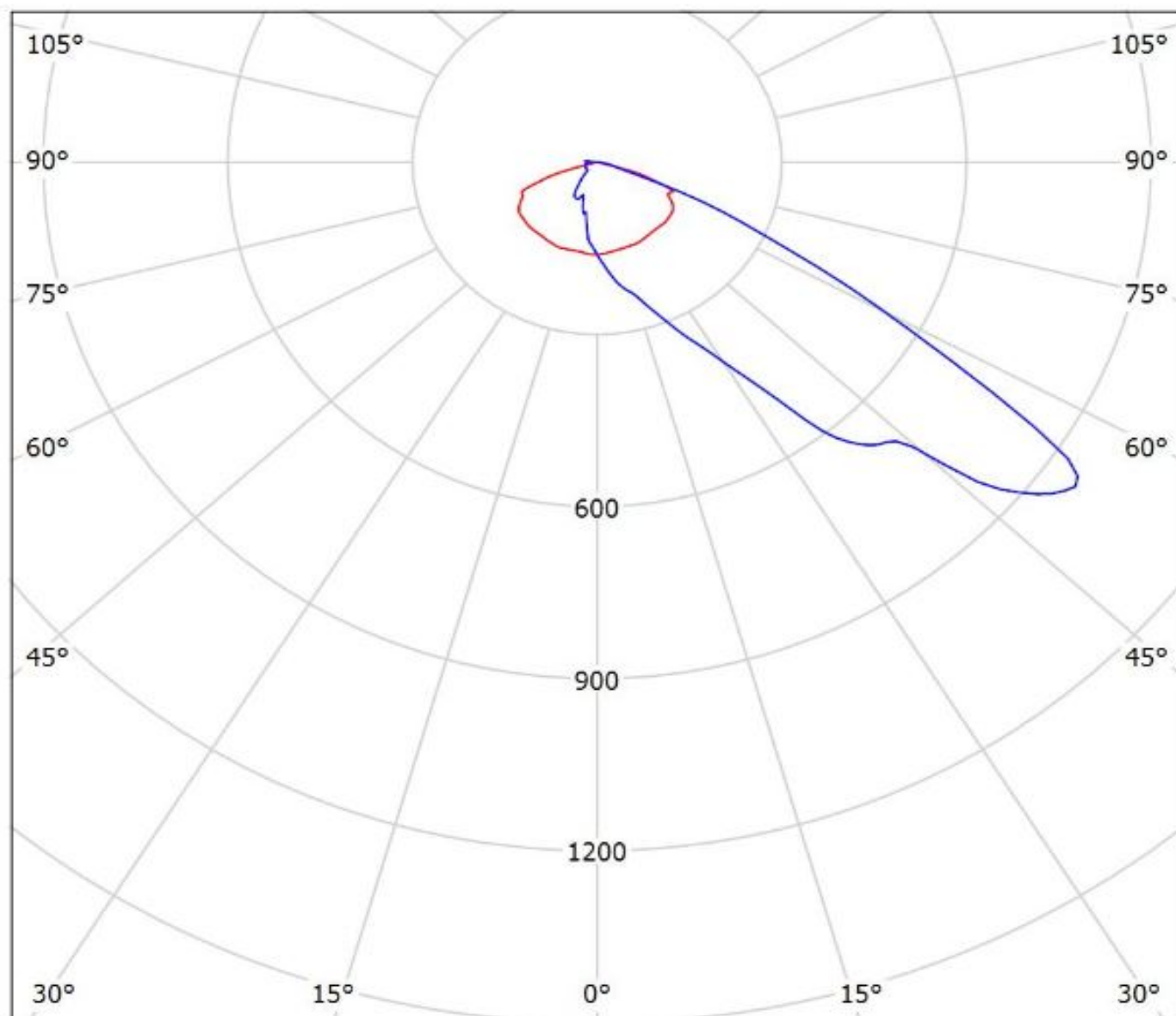

cd/klm

— C0 - C180 — C90 - C270

$\eta = 94\%$

Luminaire: Ledil CA13758_STRADA-SQ-FS-NP_(Duris_S10)

Lamps: 1 x Osram_Duris_S10_(GW-P7LP32.EM)_999.98lm@250mA_P=9.2345W_I=0.25A

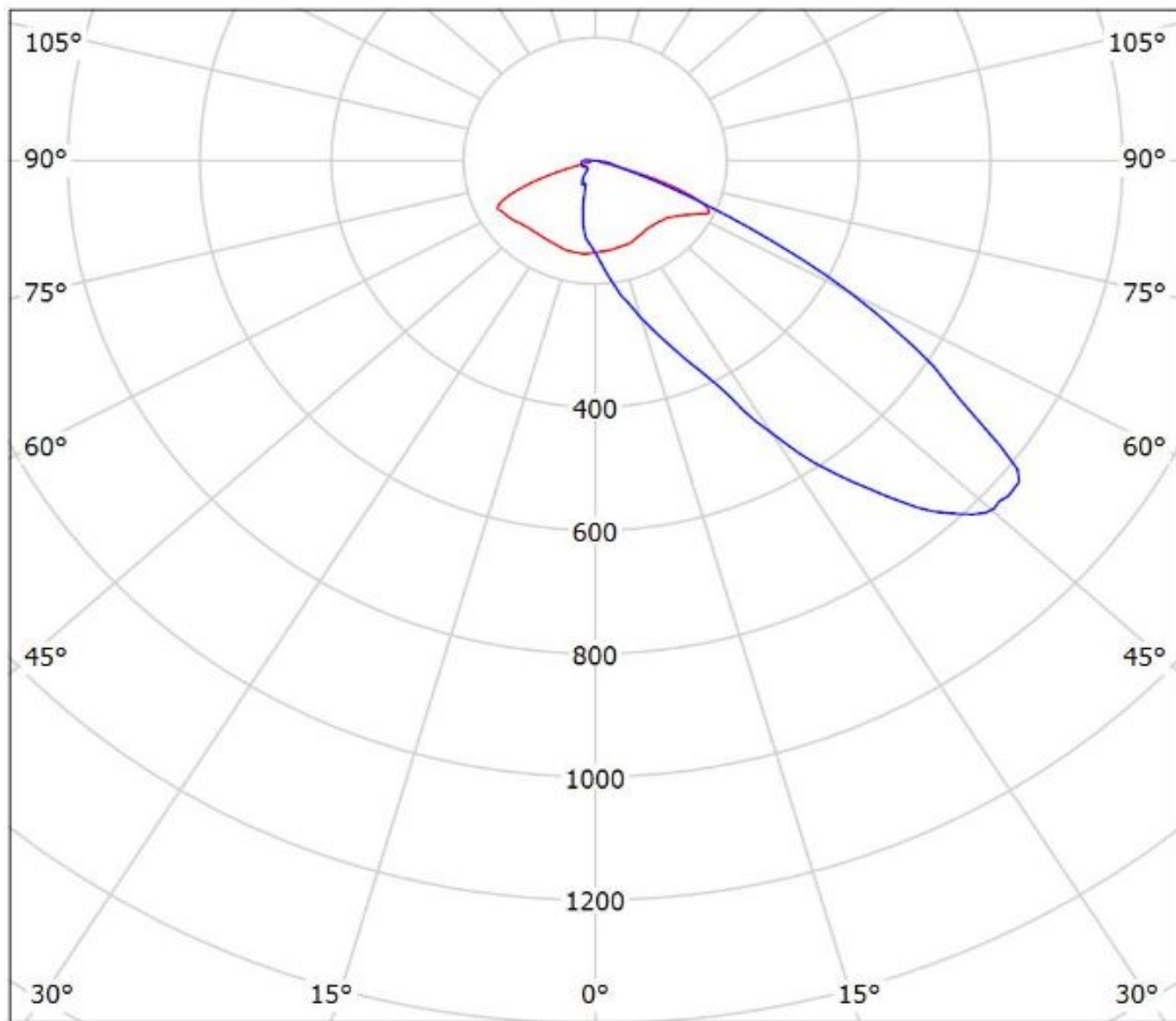

cd/klm

— C0 - C180

— C90 - C270

$\eta = 92\%$

NOTE: The typical divergence will be changed by different color, chip size and chip position tolerance. The typical total divergence is the full angle measured where the luminous intensity is half of the peak value.