

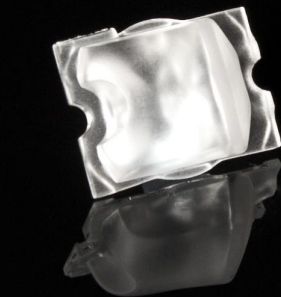

Product number CA11416_STRADA-T-DN

Family	Strada	FWHM	Asymmetric degrees
Type	Assembly	Efficiency	91 %
LED	XB-D	cd/lm	-
Color	Clear	Gerber File	Available
Diameter	19.8 x 15.5 mm		
Height	8.75 mm		
Style	Rectang		
Optic Material	PMMA		
Holder Material	-		
Fastening	["tape", "pin", "screw"]		
Status	Production ready		



Product number CA11426_STRADA-T-DW

Family	Strada	FWHM	Asymmetric degrees
Type	Assembly	Efficiency	93 %
LED	XB-D	cd/lm	-
Color	Clear	Gerber File	Available
Diameter	19.6 x 15.5 mm		
Height	10.7 mm		
Style	Rectang		
Optic Material	PMMA		
Holder Material	-		
Fastening	["pin", "tape", "screw"]		
Status	Production ready		

Product number C12049_STRADA-FT

Family	Strada	FWHM	Asymmetric degrees
Type	Lens	Efficiency	87 %
LED	XB-D	cd/lm	-
Color	Clear	Gerber File	Available
Diameter	15.4 x 19.6 mm		
Height	8.2 mm		
Style	Rectang		
Optic Material	PMMA		
Holder Material	-		
Fastening	["screw", "glue", "pin"]		
Status	Production ready		

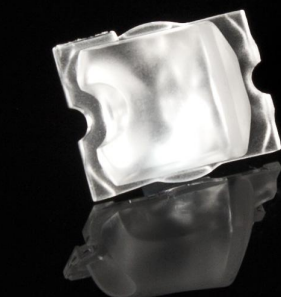
http://www.ledil.fi/Strada-F_Fully_Asymmetrical_Forward_Throw_Lens_Family

Product number CA12050_STRADA-FT

Family	Strada	FWHM	Asymmetric degrees
Type	Assembly	Efficiency	87 %
LED	XB-D	cd/lm	-
Color	Clear	Gerber File	Available
Diameter	15.4 x 19.6 mm		
Height	8.35 mm		
Style	Rectang		
Optic Material	PMMA		
Holder Material	-		
Fastening	["tape", "pin", "screw"]		
Status	Production ready		

http://www.ledil.fi/Strada-F_Fully_Asymmetrical_Forward_Throw_Lens_Family

PRODUCT DATASHEET
Strada series

last update 17/10/2016

**Product number** CA11253_STRADA-C2

Family	Strada	FWHM	135 degrees
Type	Assembly	Efficiency	93 %
LED	XB-D	cd/lm	0.260
Color	Clear	Gerber File	Available
Diameter	19.6 x 15.6 mm		
Height	5.9 mm		
Style	Rectang		
Optic Material	PMMA		
Holder Material	-		
Fastening	["tape", "pin"]		
Status	Production ready		

NOTE: The typical divergence will be changed by different color, chip size and chip position tolerance. The typical total divergence is the full angle measured where the luminous intensity is half of the peak value.



PRODUCT DATASHEET

Strada series

last update 17/10/2016

GENERAL INFORMATION

- Product series especially designed & optimized for XB-D series of LEDs.
- Special care taken to make light distribution as uniform as possible.
- Lens material optical grade PMMA with high UV and temperature resistance. Allows use of high current and temperature conditions.

Please find more information about used material from below:

http://ledil.fi/sites/default/files/Documents/Technical/Material/PMMA%20N%20UL94_Yellow%20Card.pdf

<http://ledil.fi/sites/default/files/Documents/Technical/Material/PMMA%20N%20PLEXIGLAS-Datasheet.pdf>

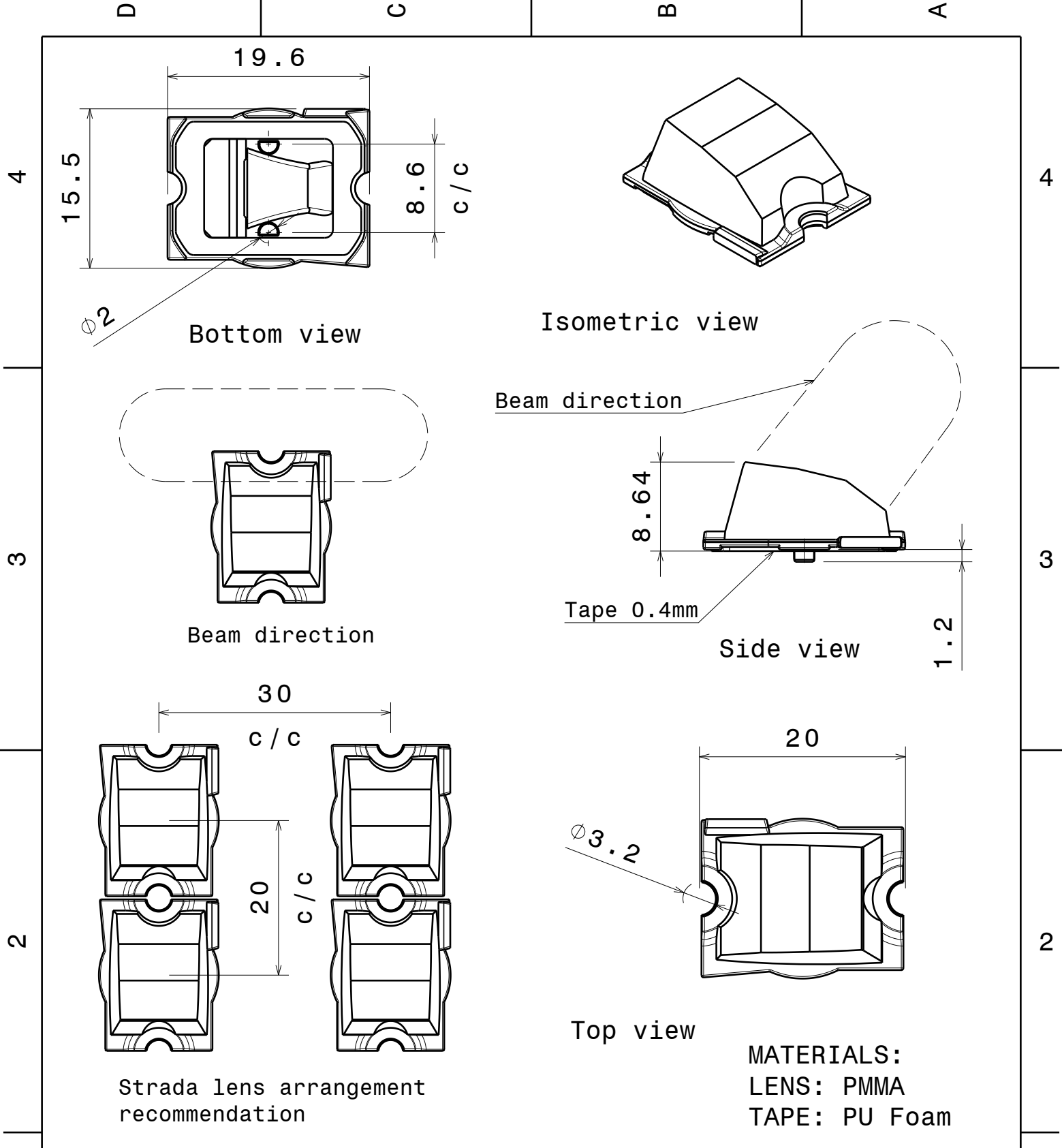

Tolerances if not otherwise shown
 According to DIN ISO 2768-1
 Linear measures: class C
 According to DIN ISO 2768-2
 Form and position: class L

LEDiL LediL Oy
 Salorankatu 10
 FIN 24240 SALO
 Finland

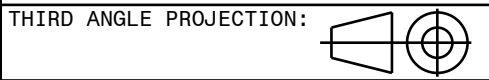

DRAWING TITLE
CA11416_STRADA-T-DN

This drawing is the property of LEDiL Oy. It may not be reproduced, copied or communicated without a written agreement with LEDiL Oy."

SIZE	PART NUMBER
A4	CA11416

SCALE	2:1	WEIGHT	1,31 g	SHEET	1/1
-------	-----	--------	--------	-------	-----

Luminaire: Ledil Oy Strada-FT-XP-D LOR=87%
Lamps: 1 x Cree XP-D 250mA 85lm

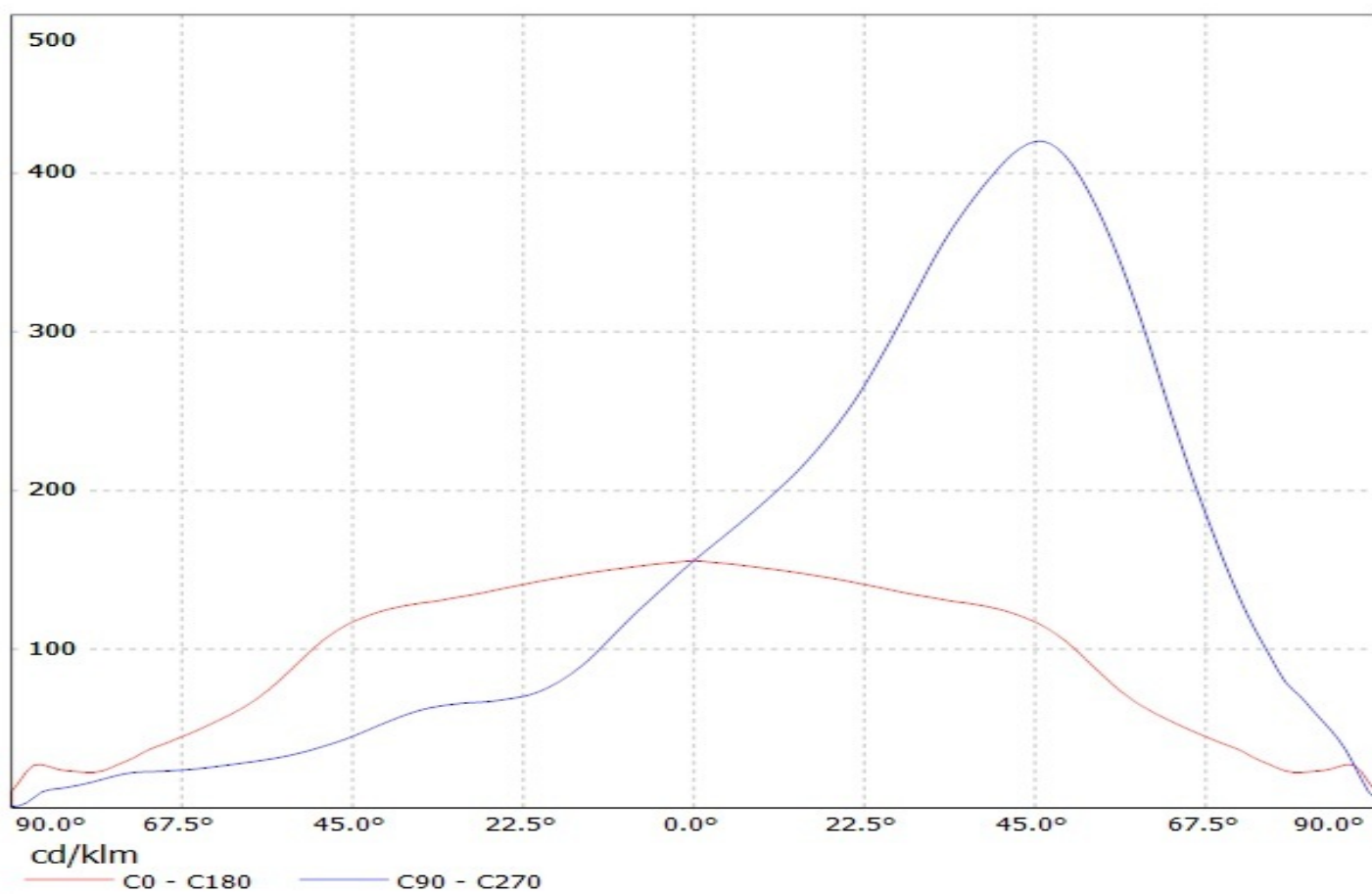

Luminaire: LEDIL OY C11252_STRADA-C2 / CA11253_STRADA-C2 (XB-D) Efficiency=93%
Lamps: 1 x Cree XB-D white (97lm @ 250mA)

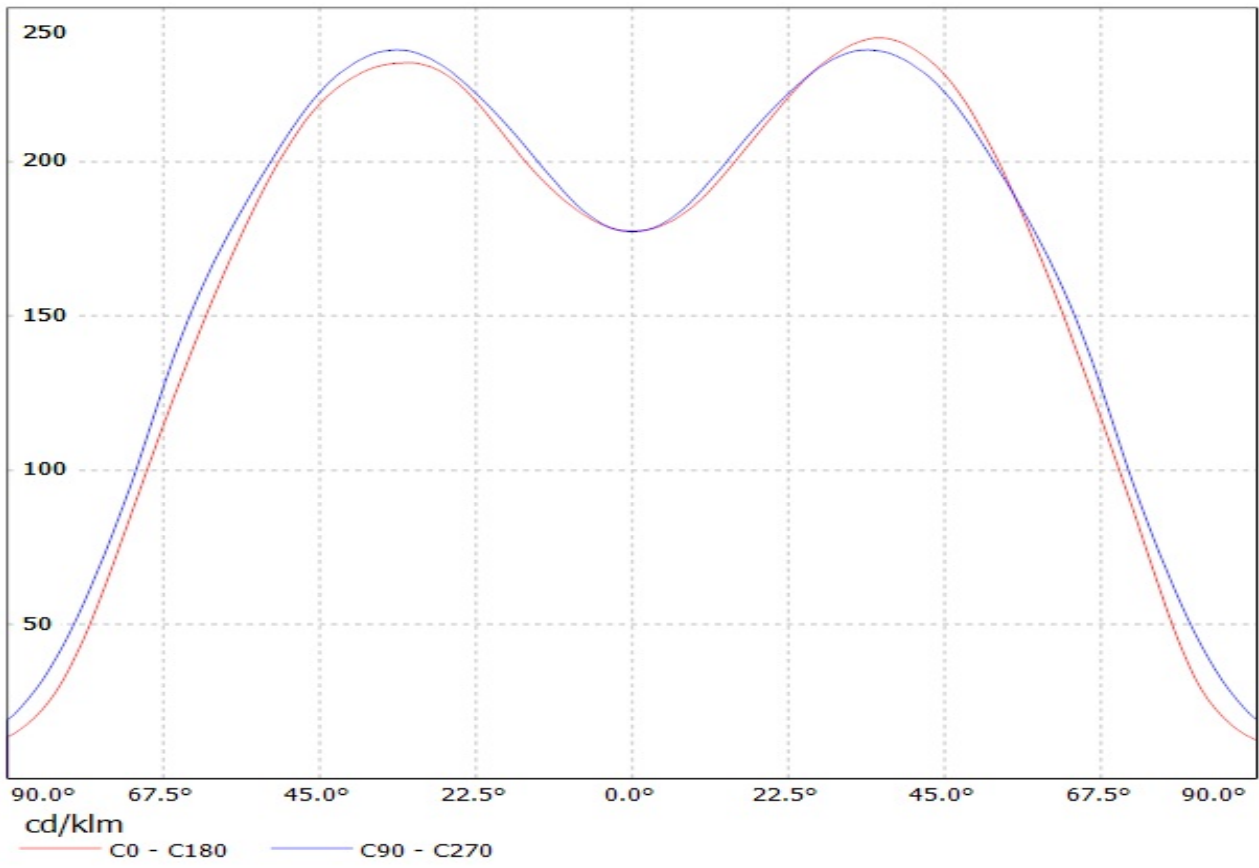

Luminaire: Ledil Oy Strada-FT-XP-D LOR=87%
Lamps: 1 x Cree XP-D 250mA 85lm

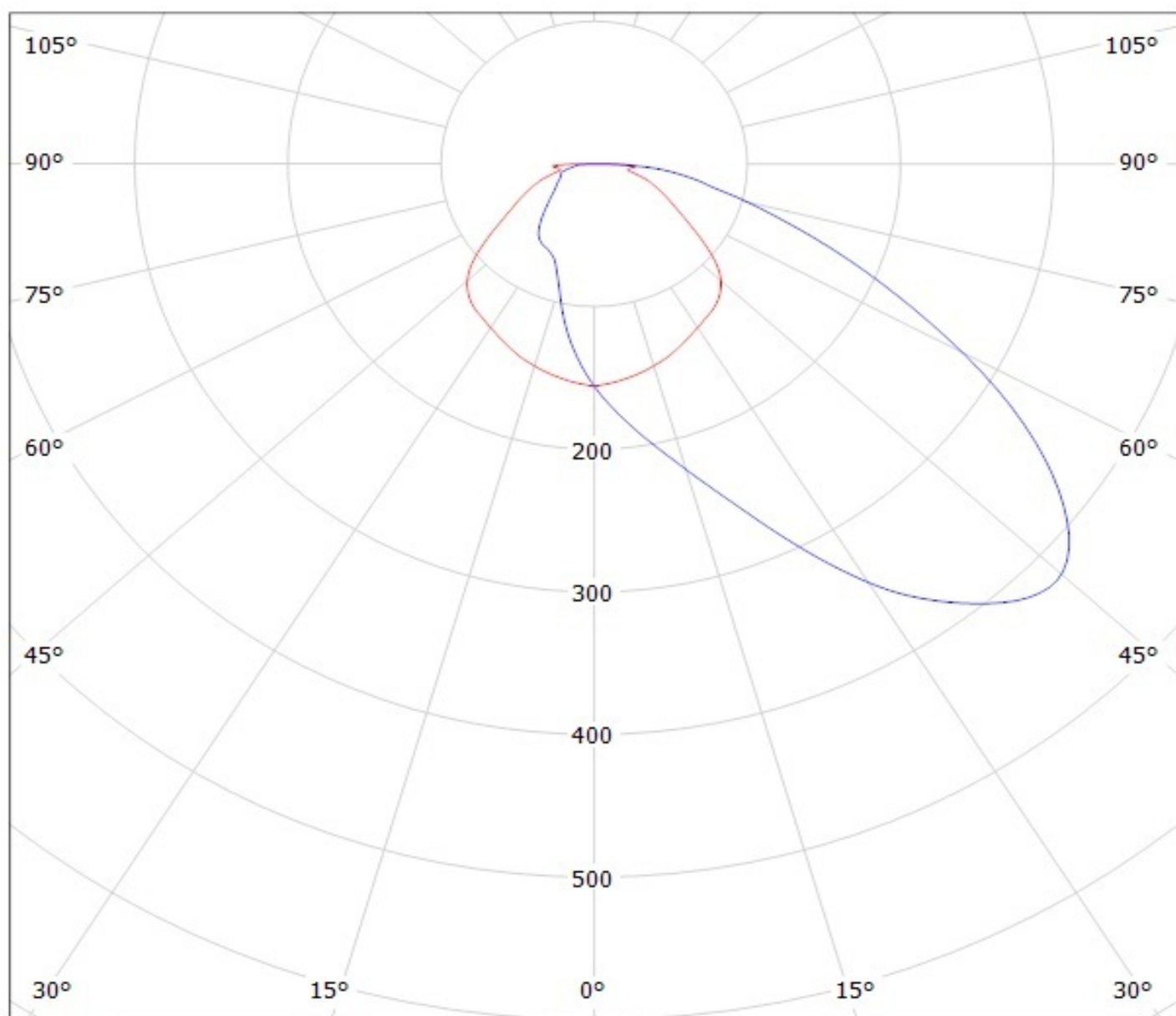

cd/klm

— C0 - C180

— C90 - C270

Luminaire: LEDIL OY C11252_STRADA-C2 / CA11253_STRADA-C2 (XB-D) Efficiency=93%
Lamps: 1 x Cree XB-D white (97lm @ 250mA)

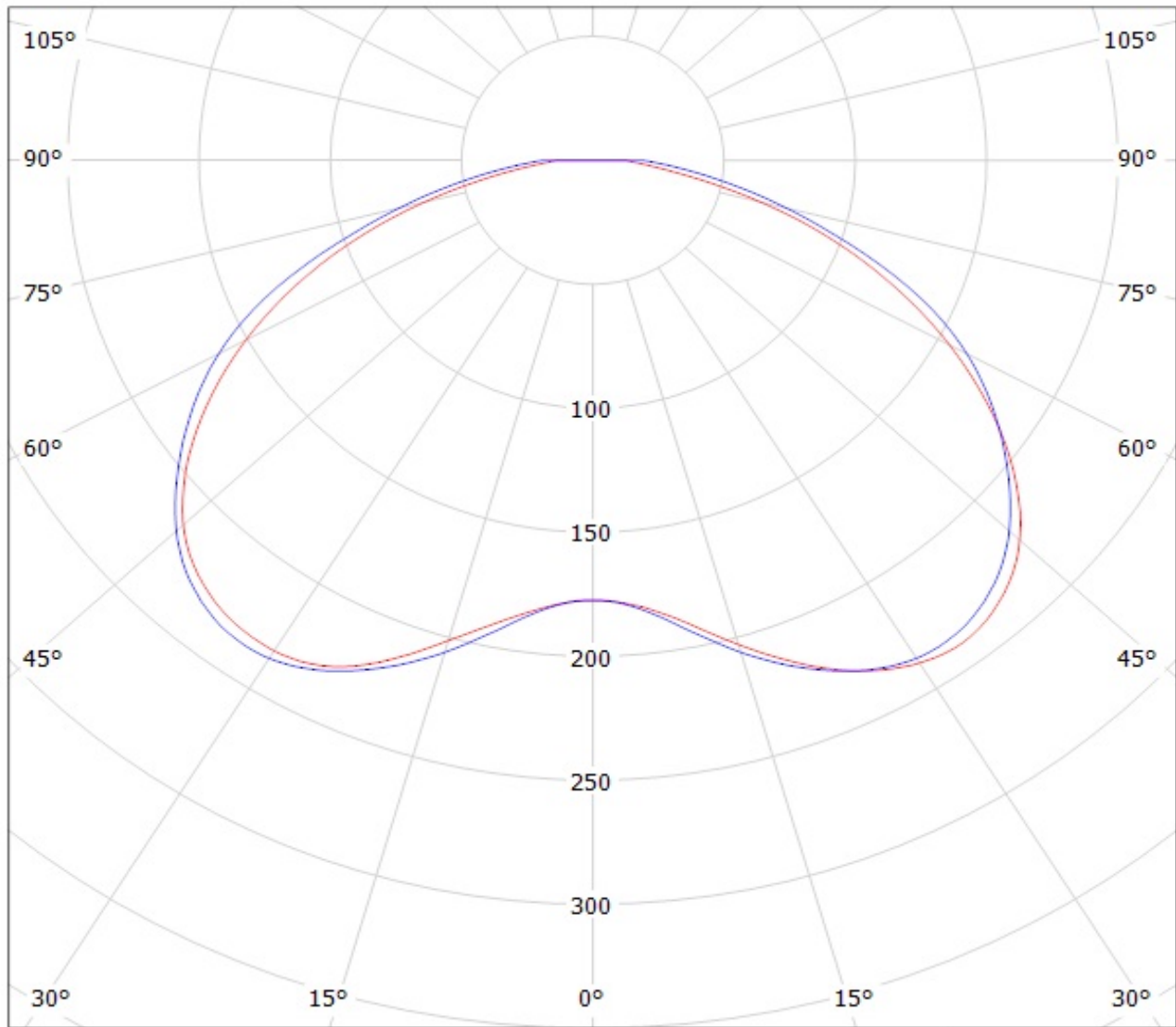

cd/klm

— C0 - C180 — C90 - C270