

# Bridgelux® Vero® 18 Array Series

Product Data Sheet DS32



BXRC-27X4000

30X4000

35X4000

40X4000

50X4000

# Introduction

Vero



Vero represents a revolutionary advancement in chip on board (COB) light source technology and innovation. Vero LED light sources simplify luminaire design and manufacturing processes, improve light quality, and define a platform for future functionality integration.

Vero is available in four different light emitting surface (LES) configurations and has been engineered to reliably operate over a broad current range, enabling new degrees of flexibility in luminaire design optimization. Vero arrays deliver increased lumen density to enable improved beam control and precision lighting with 2 and 3 SDCM color control standard for clean and consistent uniform lighting.

Vero includes an on board connector port to enable solder free electrical interconnect and simple easy to use mounting features to enable plug-and-play installation.

## Features

- Market leading efficacy of 130 lm/W typical
- Vero 18 lumen output performance ranges from 1600 to 7600 lumens
- Broad range of CCT options from 2700K to 5000K
- CRI options include minimum 70, 80, and 90, 2 and 3 SDCM color control for 2700K-4000K CCT
- Reliable operation at up to 2X nominal drive current
- Radial die pattern and improved lumen density
- Thermally isolated solder pads
- Onboard connector port
- Top side part number markings

## Benefits

- Broad application coverage for interior and exterior lighting
- Flexibility for application driven lighting design requirements
- High quality true color reproduction
- Uniform consistent white light
- Flexibility in design optimization
- Improved optical control
- Enhanced ease of use and manufacturability
- Solderless connectivity enables plug & play installation and field upgradability
- Improved inventory management and quality control

# Contents

Product Feature Map	2
Product Nomenclature	2
Product Selection Guide	3
Performance at Commonly Used Drive Currents	4
Electrical Characteristics	6
Absolute Maximum Ratings	7
Performance Curves	8
Typical Radiation Pattern	11
Typical Color Spectrum	12
Mechanical Dimensions	13
Color Binning Information	14
Packaging and Labeling	15
Design Resources	17
Precautions	17
Disclaimers	17
About Bridgelux	18

---

# Product Feature Map

Vero 18 is the second largest form factor in the Vero family of next generation solid state light sources. In addition to delivering the performance and light quality required for many lighting applications, Vero incorporates

several features to simplify the design integration and manufacturing process, accelerate time to market and reduce system costs. Please consult the Bridgelux Vero Array Series Product Brief for more information on the Vero family of products.

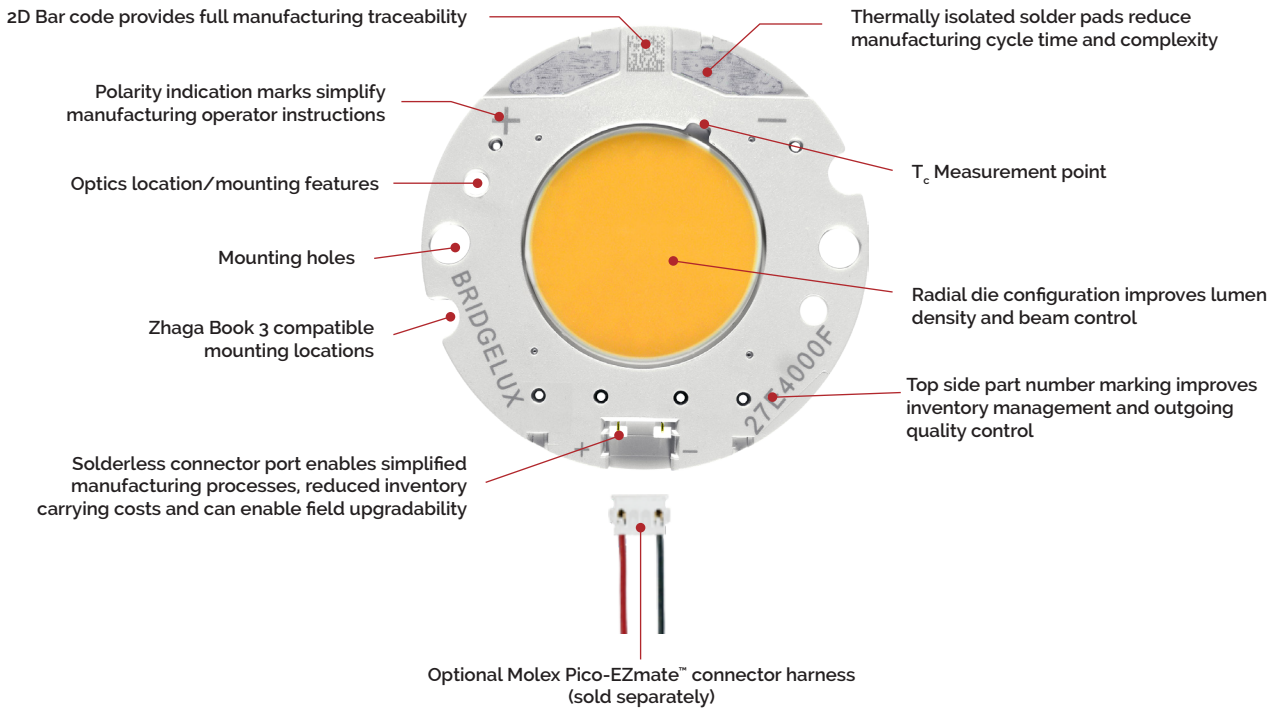

## Product Nomenclature

The part number designation for Bridgelux Vero LED arrays is explained as follows:

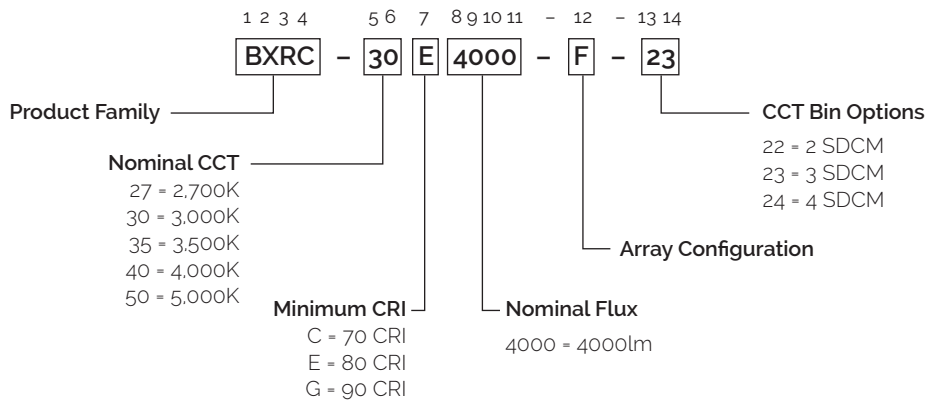

# Product Selection Guide

The following product configurations are available:

**Table 1:** Selection Guide, Pulsed Measurement Data ( $T_j = T_c = 25^\circ\text{C}$ )

Part Number	Nominal CCT <sup>1</sup> (K)	CRI <sup>2</sup>	Nominal Drive Current <sup>3</sup> (mA)	Typical Pulsed Flux <sup>4,5,6</sup> $T_c = 25^\circ\text{C}$ (lm)	Minimum Pulsed Flux <sup>6,7</sup> $T_c = 25^\circ\text{C}$ (lm)	Typical $V_f$ (V)	Typical Power (W)	Typical Efficacy (lm/W)
BXRC-27E4000-F-2x	2700	80	1050	3872	3605	29.5	31.0	125
BXRC-27G4000-F-2x	2700	90	1050	3221	2832	29.5	31.0	104
BXRC-30E4000-F-2x	3000	80	1050	4050	3691	29.5	31.0	131
BXRC-30G4000-F-2x	3000	90	1050	3376	2929	29.5	31.0	109
BXRC-35E4000-F-2x	3500	80	1050	4150	3760	29.5	31.0	134
BXRC-35G4000-F-2x	3500	90	1050	3655	3150	29.5	31.0	118
BXRC-40E4000-F-2x	4000	80	1050	4244	3884	29.5	31.0	137
BXRC-40G4000-F-2x	4000	90	1050	3670	3300	29.5	31.0	118
BXRC-50C4000-F-24	5000	70	1050	4491	4000	29.5	31.0	145
BXRC-50E4000-F-24	5000	80	1050	4275	3783	29.5	31.0	138
BXRC-50G4000-F-24	5000	90	1050	3885	3560	29.5	31.0	125

**Table 2:** Selection Guide, Stabilized DC Performance ( $T_c = 85^\circ\text{C}$ )<sup>8,9</sup>

Part Number	Nominal CCT <sup>1</sup> (K)	CRI <sup>2</sup>	Nominal Drive Current <sup>3</sup> (mA)	Typical DC Flux $T_c = 85^\circ\text{C}$ (lm)	Minimum DC Flux <sup>10</sup> $T_c = 85^\circ\text{C}$ (lm)	Typical $V_f$ (V)	Typical Power (W)	Typical Efficacy (lm/W)
BXRC-27E4000-F-2x	2700	80	1050	3512	3269	28.6	30.0	117
BXRC-27G4000-F-2x	2700	90	1050	2834	2492	28.6	30.0	94
BXRC-30E4000-F-2x	3000	80	1050	3662	3337	28.6	30.0	122
BXRC-30G4000-F-2x	3000	90	1050	2971	2578	28.6	30.0	99
BXRC-35E4000-F-2x	3500	80	1050	3770	3416	28.6	30.0	126
BXRC-35G4000-F-2x	3500	90	1050	3216	2772	28.6	30.0	107
BXRC-40E4000-F-2x	4000	80	1050	3833	3508	28.6	30.0	128
BXRC-40G4000-F-2x	4000	90	1050	3230	2904	28.6	30.0	108
BXRC-50C4000-F-24	5000	70	1050	3952	3520	28.6	30.0	132
BXRC-50E4000-F-24	5000	80	1050	3762	3329	28.6	30.0	125

Notes for Tables 1 & 2:

- Nominal CCT as defined by ANSI C78.377-2011.
- CRI Values are minimums. Minimum R<sub>g</sub> value for 80 CRI products is 0, the minimum R<sub>g</sub> values for 90 CRI products is 50.
- Drive current is referred to as nominal drive current.
- Products tested under pulsed condition (10ms pulse width) at nominal test current where  $T_j$  (junction temperature) -  $T_c$  (case temperature) =  $25^\circ\text{C}$ .
- Typical performance values are provided as a reference only and are not a guarantee of performance.
- Bridgelux maintains a  $\pm 7\%$  tolerance on flux measurements.
- Minimum flux values at the nominal test current are guaranteed by 100% test.
- Typical stabilized DC performance values are provided as reference only and are not a guarantee of performance.
- Typical performance is estimated based on operation under DC (direct current) with LED array mounted onto a heat sink with thermal interface material and the case temperature maintained at  $85^\circ\text{C}$ . Based on Bridgelux test setup, values may vary depending on the thermal design of the luminaire and/or the exposed environment to which the product is subjected.
- Minimum flux values at elevated temperatures are provided for reference only and are not guaranteed by 100% production testing. Based on Bridgelux test setup, values may vary depending on the thermal design of the luminaire and/or the exposed environment to which the product is subjected.

# Performance at Commonly Used Drive Currents

Vero LED arrays are tested to the specifications shown using the nominal drive currents in Table 1. Vero may also be driven at other drive currents dependent on specific application design requirements. The performance at any drive current can be derived from the current vs. voltage characteristics shown in Figure 1 and the flux vs. current characteristics shown in Figure 2. The performance at commonly used drive currents is summarized in Table 3.

**Table 3:** Performance at Commonly Used Drive Currents

Part Number	CRI	Drive Current <sup>1</sup> (mA)	Typical $V_f$ $T_c = 25^\circ\text{C}$ (V)	Typical Power $T_c = 25^\circ\text{C}$ (W)	Typical Flux <sup>2</sup> $T_c = 25^\circ\text{C}$ (lm)	Typical DC Flux <sup>3</sup> $T_c = 85^\circ\text{C}$ (lm)	Typical Efficacy $T_c = 25^\circ\text{C}$ (lm/W)
BXRC-27E4000-F-2x	80	500	28.1	14.1	1996	1804	142
		700	28.7	20.1	2717	2457	135
		<b>1050</b>	<b>29.5</b>	<b>31.0</b>	<b>3872</b>	<b>3512</b>	<b>125</b>
		1400	30.2	42.3	4919	4473	116
		2100	31.6	66.4	6624	6071	100
BXRC-27G4000-F-2x	90	500	28.1	14.1	1660	1456	118
		700	28.7	20.1	2260	1983	112
		<b>1050</b>	<b>29.5</b>	<b>31.0</b>	<b>3221</b>	<b>2834</b>	<b>104</b>
		1400	30.2	42.3	4092	3610	97
		2100	31.6	66.4	5511	4901	83
BXRC-30E4000-F-2x	80	500	28.1	14.1	2088	1882	149
		700	28.7	20.1	2841	2562	141
		<b>1050</b>	<b>29.5</b>	<b>31.0</b>	<b>4050</b>	<b>3662</b>	<b>131</b>
		1400	30.2	42.3	5145	4664	122
		2100	31.6	66.4	6929	6331	104
BXRC-30G4000-F-2x	90	500	28.1	14.1	1740	1527	124
		700	28.7	20.1	2369	2079	118
		<b>1050</b>	<b>29.5</b>	<b>31.0</b>	<b>3376</b>	<b>2971</b>	<b>109</b>
		1400	30.2	42.3	4289	3784	101
		2100	31.6	66.4	5776	5136	87
BXRC-35E4000-F-2x	80	500	28.1	14.1	2139	1937	152
		700	28.7	20.1	2912	2638	145
		<b>1050</b>	<b>29.5</b>	<b>31.0</b>	<b>4150</b>	<b>3770</b>	<b>134</b>
		1400	30.2	42.3	5272	4802	125
		2100	31.6	66.4	7100	6518	107
BXRC-35G4000-F-2x	90	500	28.1	14.1	1884	1653	134
		700	28.7	20.1	2564	2250	128
		<b>1050</b>	<b>29.5</b>	<b>31.0</b>	<b>3655</b>	<b>3216</b>	<b>118</b>
		1400	30.2	42.3	4643	4097	110
		2100	31.6	66.4	6253	5561	94

Notes for Table 3:

1. Alternate drive currents in Table 3 are provided for reference only and are not a guarantee of performance.
2. Bridgelux maintains a  $\pm 7\%$  tolerance on flux measurements.
3. Typical stabilized DC performance values are provided as reference only and are not a guarantee of performance.

# Performance at Commonly Used Drive Currents

**Table 3:** Performance at Commonly Used Drive Currents (Continued)

Part Number	CRI	Drive Current <sup>1</sup> (mA)	Typical $V_f$ $T_c = 25^\circ\text{C}$ (V)	Typical Power $T_c = 25^\circ\text{C}$ (W)	Typical Flux <sup>2</sup> $T_c = 25^\circ\text{C}$ (lm)	Typical DC Flux <sup>3</sup> $T_c = 85^\circ\text{C}$ (lm)	Typical Efficacy $T_c = 25^\circ\text{C}$ (lm/W)
BXRC-40E4000-F-2x	80	500	28.1	14.1	2188	1969	156
		700	28.7	20.1	2977	2682	148
		<b>1050</b>	<b>29.5</b>	<b>31.0</b>	<b>4244</b>	<b>3833</b>	<b>137</b>
		1400	30.2	42.3	5392	4882	128
		2100	31.6	66.4	7261	6627	109
BXRC-40G4000-F-2x	90	500	28.1	14.1	1892	1659	135
		700	28.7	20.1	2575	2260	128
		<b>1050</b>	<b>29.5</b>	<b>31.0</b>	<b>3670</b>	<b>3230</b>	<b>118</b>
		1400	30.2	42.3	4662	4113	110
		2100	31.6	66.4	6279	5584	95
BXRC-50C4000-F-24	70	500	28.1	14.1	2315	2031	165
		700	28.7	20.1	3151	2765	157
		<b>1050</b>	<b>29.5</b>	<b>31.0</b>	<b>4491</b>	<b>3952</b>	<b>145</b>
		1400	30.2	42.3	5705	5034	135
		2100	31.6	66.4	7683	6833	116
BXRC-50E4000-F-24	80	500	28.1	14.1	2204	1933	157
		700	28.7	20.1	2999	2632	149
		<b>1050</b>	<b>29.5</b>	<b>31.0</b>	<b>4275</b>	<b>3762</b>	<b>138</b>
		1400	30.2	42.3	5431	4791	128
		2100	31.6	66.4	7314	6504	110
BXRC-50G4000-F-24	90	500	28.1	14.1	2003	1757	143
		700	28.7	20.1	2726	2392	136
		<b>1050</b>	<b>29.5</b>	<b>31.0</b>	<b>3885</b>	<b>3419</b>	<b>125</b>
		1400	30.2	42.3	4936	4354	117
		2100	31.6	66.4	6647	5911	100

Notes for Table 3:

1. Alternate drive currents in Table 3 are provided for reference only and are not a guarantee of performance.
2. Bridgelux maintains a  $\pm 7\%$  tolerance on flux measurements.
3. Typical stabilized DC performance values are provided as reference only and are not a guarantee of performance.

# Electrical Characteristics

**Table 4:** Electrical Characteristics

Part Number	Drive Current (mA)	Forward Voltage Pulsed, $T_c = 25^\circ\text{C}$ (V) <sup>1, 2, 3</sup>			Typical Coefficient of Forward Voltage <sup>4</sup> $\Delta V_f / \Delta T$ (mV/ $^\circ\text{C}$ )	Typical Thermal Resistance Junction to Case <sup>5, 6</sup> $R_{j-c}$ (C/W)	Driver Selection Voltages <sup>7</sup> (V)	
		Minimum	Typical	Maximum			$V_f$ Min. Hot $T_c = 105^\circ\text{C}$ (V)	$V_f$ Max. Cold $T_c = -40^\circ\text{C}$ (V)
BXRC-xxx4000-F-2x	1050	27.3	29.5	31.7	-15	0.13	26.1	32.7
	2100	29.2	31.6	34.2	-15	0.17	28.0	35.2

Notes for Table 4:

- Parts are tested in pulsed conditions,  $T_c = 25^\circ\text{C}$ . Pulse width is 10ms.
- Voltage minimum and maximum are provided for reference only and are not a guarantee of performance.
- Bridgelux maintains a tester tolerance of  $\pm 0.10\text{V}$  on forward voltage measurements.
- Typical coefficient of forward voltage tolerance is  $\pm 0.1\text{mV}$  for nominal current.
- Thermal resistance values are based from test data of a 3000K 80 CRI product.
- Thermal resistance value was calculated using total electrical input power; optical power was not subtracted from input power. The thermal interface material used during testing is not included in the thermal resistance value.
- $V_f$  min hot and max cold values are provided as reference only and are not guaranteed by test. These values are provided to aid in driver design and selection over the operating range of the product.



# Absolute Maximum Ratings

**Table 5:** Maximum Ratings

Parameter	Maximum Rating
LED Junction Temperature ( $T_j$ )	150°C
Storage Temperature	-40°C to +105°C
Operating Case Temperature <sup>1</sup> ( $T_c$ )	105°C
Soldering Temperature <sup>2</sup>	350°C or lower for a maximum of 10 seconds
Maximum Drive Current <sup>3,4,5</sup>	2100mA
Maximum Peak Pulsed Drive Current <sup>6</sup>	3000mA
Maximum Reverse Voltage <sup>7</sup>	-55V

Notes for Table 5:

1. For IEC 62717 requirement, please consult your Bridgelux sales representative.
2. Refer to Bridgelux Application Note AN31: Assembly Considerations for Bridgelux Vero LED Arrays.
3. DC Forward Current for LM-80 is the maximum drive current for which LM-80 data is currently available.
4. Lumen maintenance (L70) and lifetime predictions are valid for drive current and case temperature conditions used for LM-80 testing as included in the applicable LM-80 test report for these arrays. Contact your Bridgelux sales representatives for LM-80 report.
5. Arrays may be driven at higher currents however lumen maintenance may be reduced.
6. Bridgelux recommends a maximum duty cycle of 10% and pulse width of 20 ms when operating LED Arrays at maximum peak pulsed current specified. Maximum peak pulsed currents indicate values where LED Arrays can be driven without catastrophic failures.
7. Light emitting diodes are not designed to be driven in reverse voltage and will not produce light under this condition. Maximum rating provided for reference only.

# Performance Curves

Figure 1: Drive Current vs. Voltage ( $T_j = T_c = 25^\circ\text{C}$ )

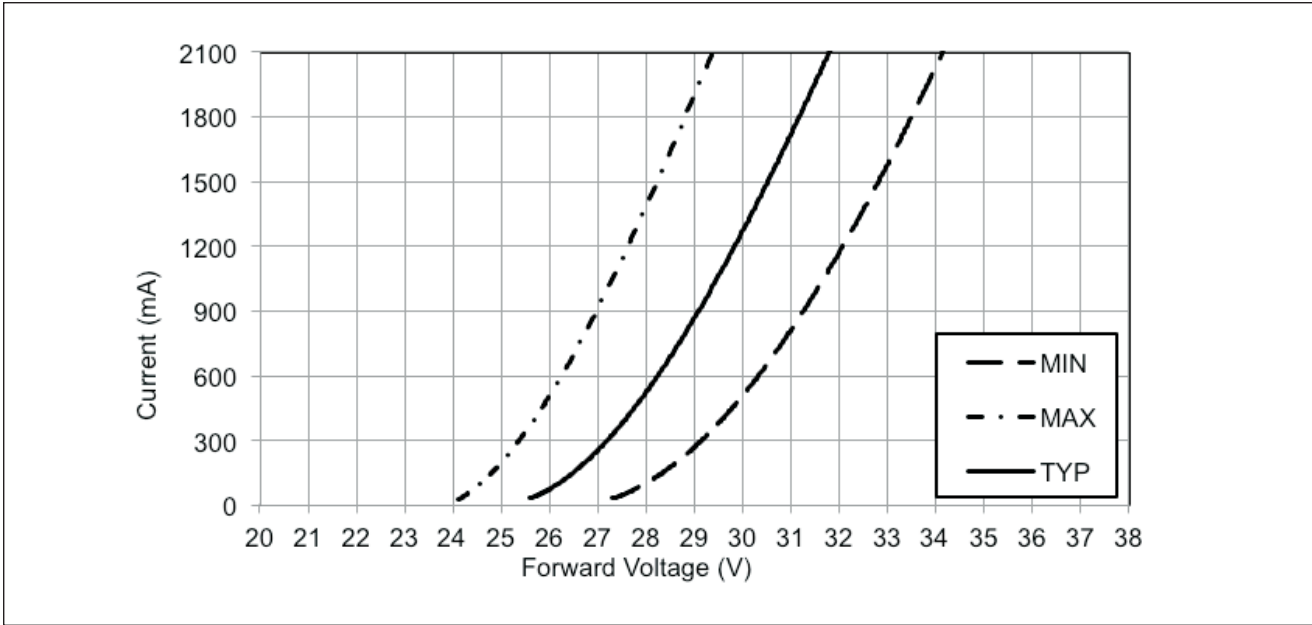
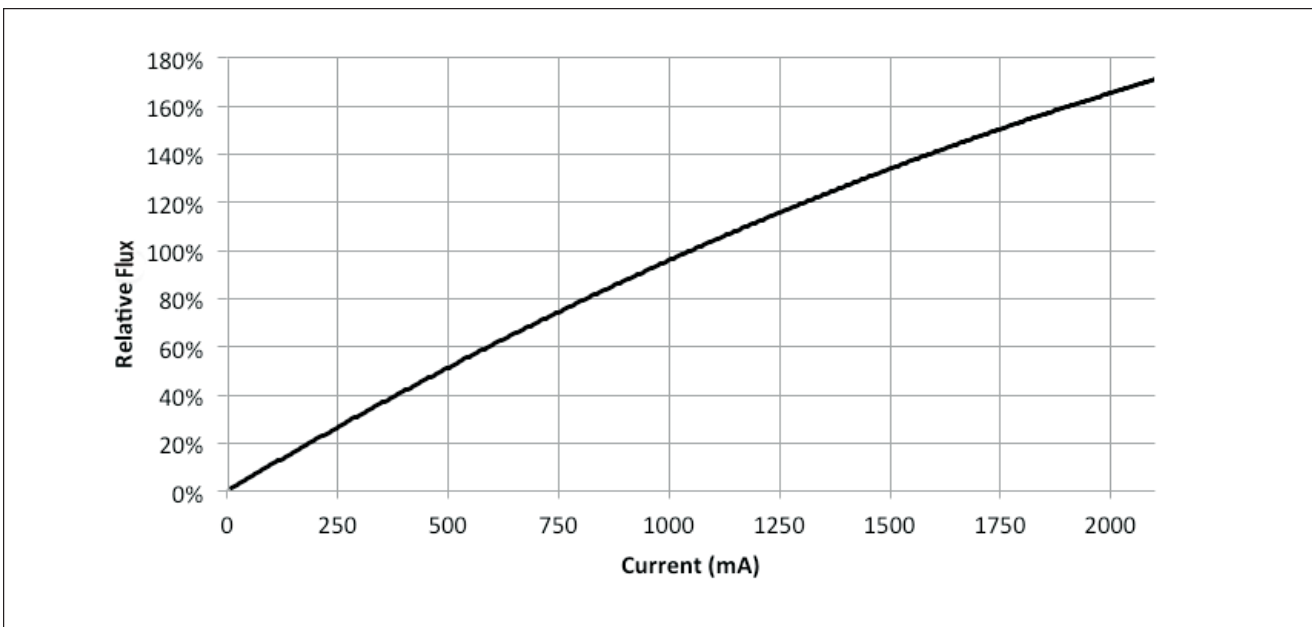

Figure 2: Typical Relative Luminous Flux vs. Drive Current ( $T_j = T_c = 25^\circ\text{C}$ )



Note for Figure 2:

1. Bridgelux does not recommend driving high power LEDs at low currents. Doing so may produce unpredictable results. Pulse width modulation (PWM) is recommended for dimming effects.

# Performance Curves

Figure 3: Typical DC Flux vs. Case Temperature

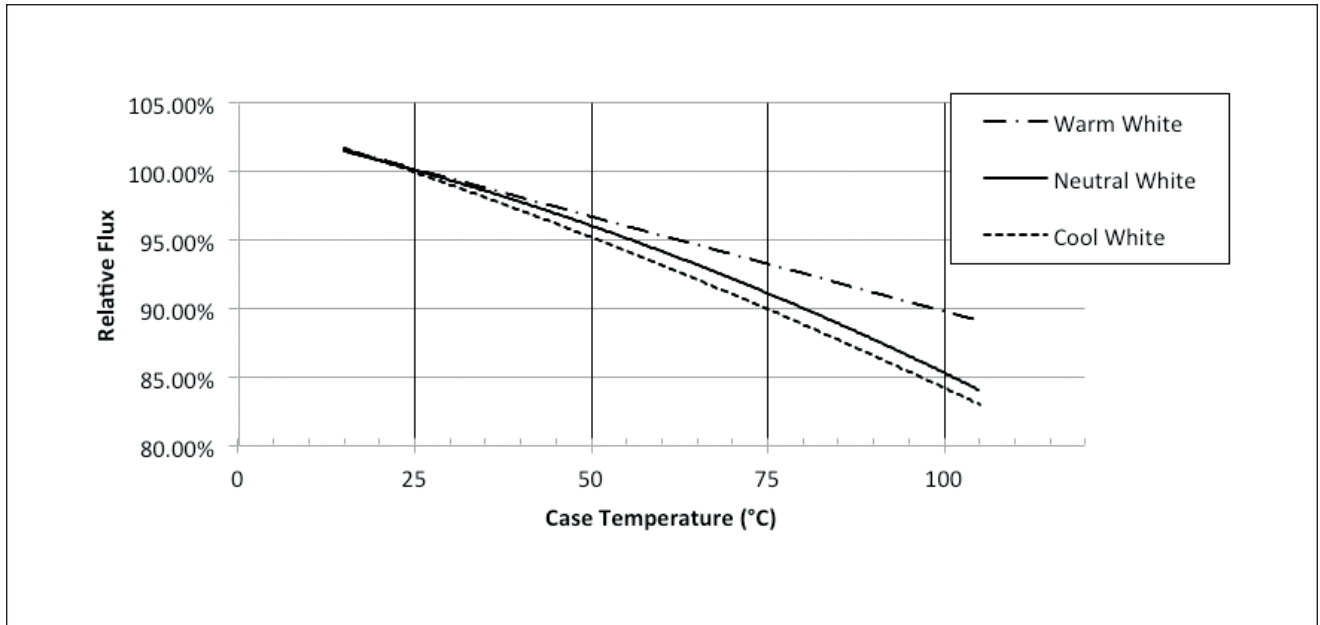
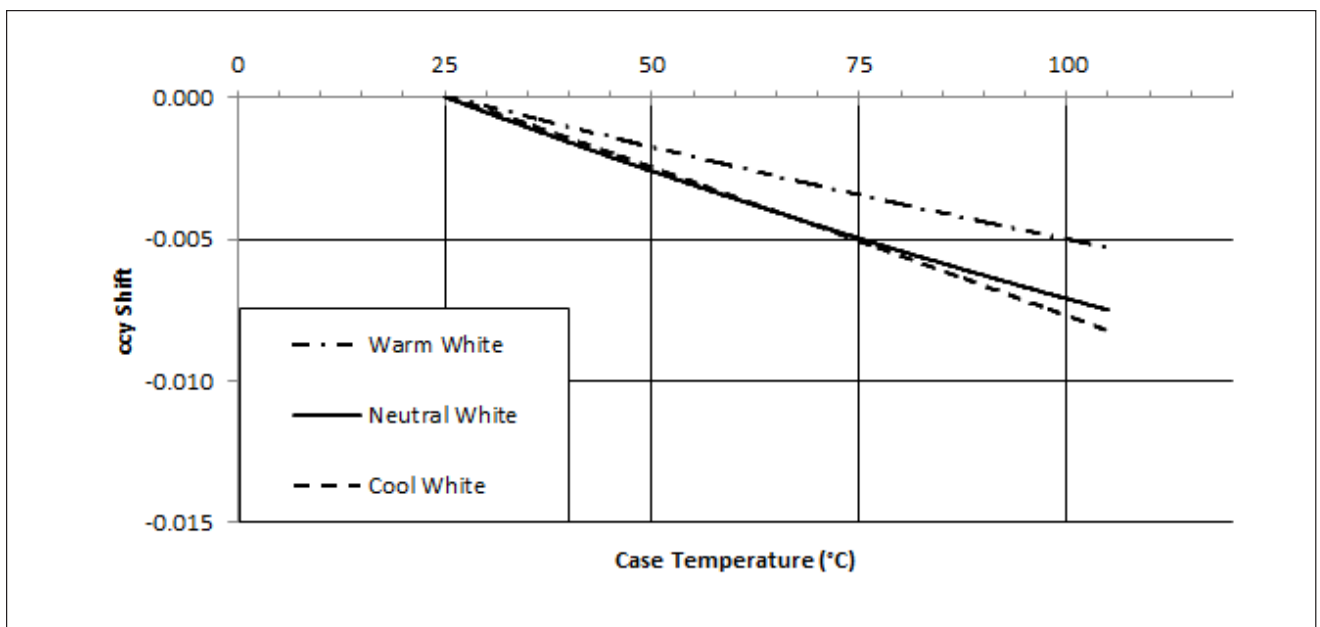

Figure 4: Typical DC ccy Shift vs. Case Temperature



Notes for Figures 3-4:

1. Characteristics shown for warm white based on 3000K and 80 CRI.
2. Characteristics shown for neutral white based on 4000K and 80 CRI.
3. Characteristics shown for cool white based on 5000K and 70 CRI.
4. For other color SKUs, the shift in color will vary. Please contact your Bridgelux Sales Representative for more information.

# Performance Curves

**Figure 5: Typical DC ccx Shift vs. Case Temperature**

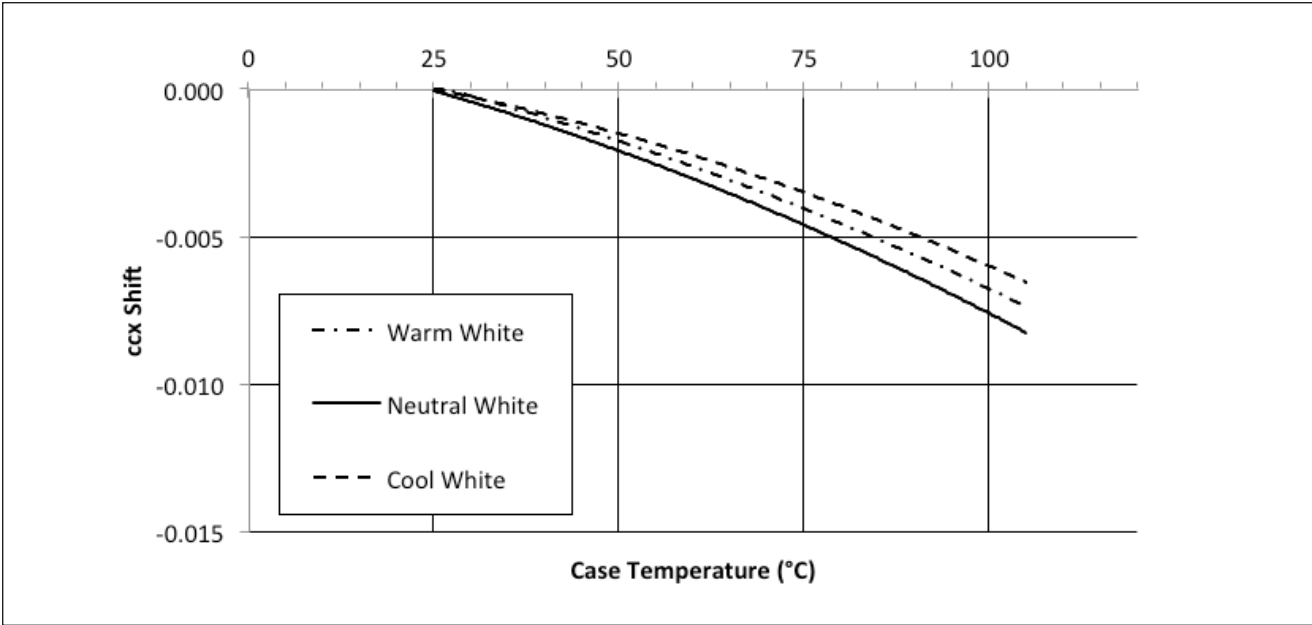

Notes for Figure 5:

- 1. Characteristics shown for warm white based on 3000K and 80 CRI.
- 2. Characteristics shown for neutral white based on 4000K and 80 CRI.
- 3. Characteristics shown for cool white based on 5000K and 70 CRI.
- 4. For other color SKUs, the shift in color will vary. Please contact your Bridgelux Sales Representative for more information.

# Typical Radiation Pattern

Figure 6: Typical Spatial Radiation Pattern

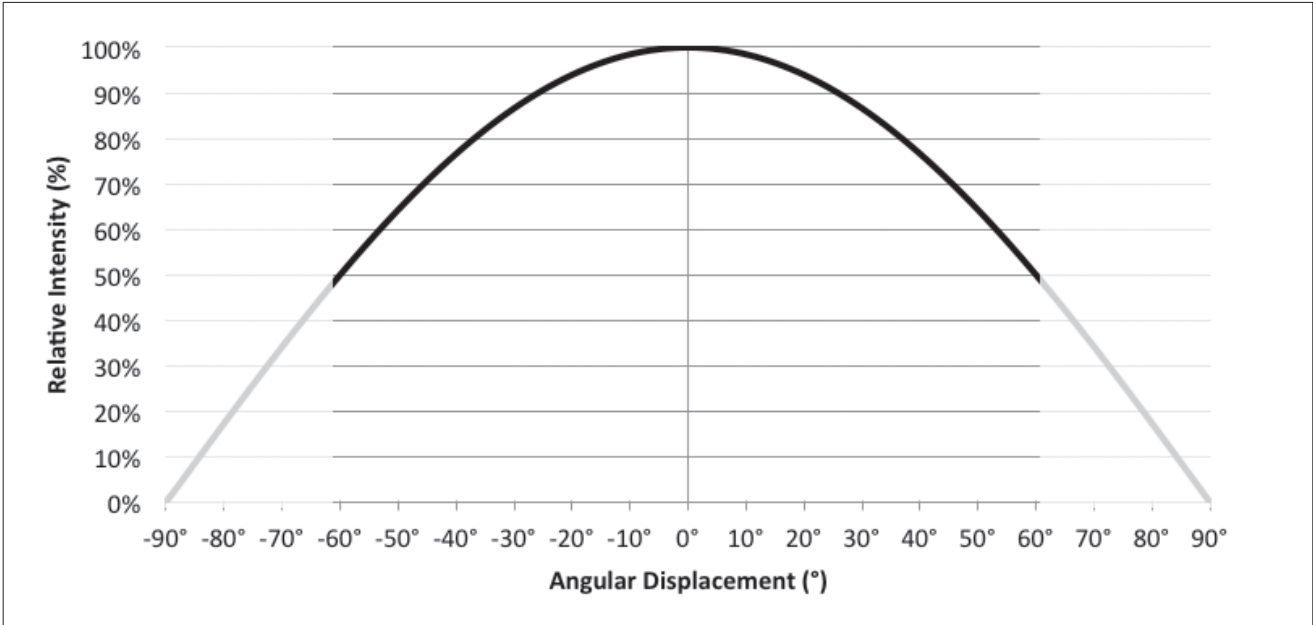

Note for Figure 6:

- 1. Typical viewing angle is 120°.
- 2. The viewing angle is defined as the off axis angle from the centerline where  $I_v$  is  $\frac{1}{2}$  of the peak value.

Figure 7: Typical Polar Radiation Pattern

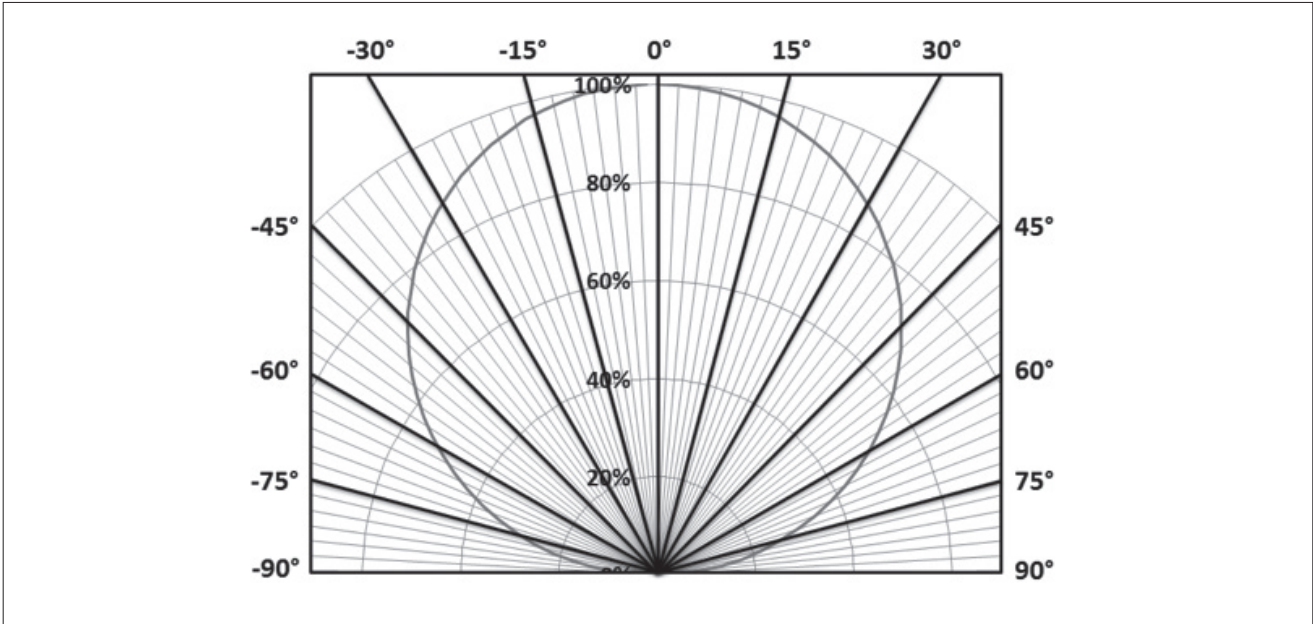

# Typical Color Spectrum

Figure 8: Typical Color Spectrum

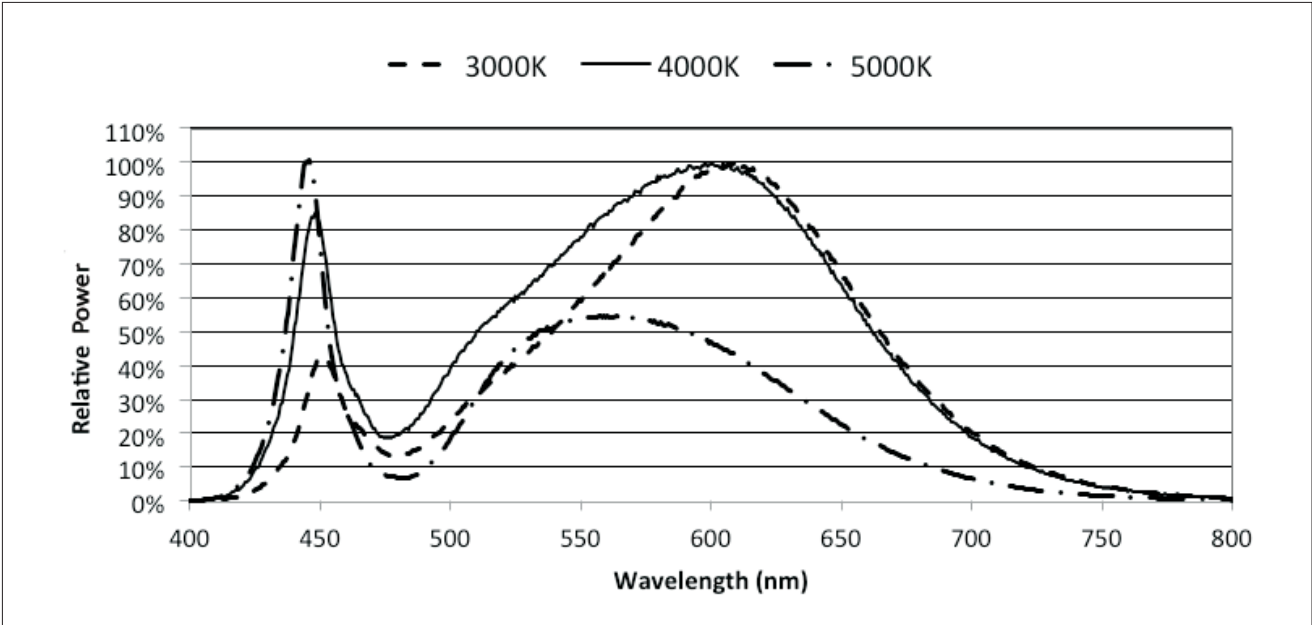

- Notes for Figure 8:
1. Color spectra measured at nominal current for  $T_j = T_c = 25^\circ\text{C}$ .
  2. Color spectra shown for warm white is 3000K and 80 CRI.
  3. Color spectra shown for neutral white is 4000K and 80 CRI.
  4. Color spectra shown for cool white is 5000K and 70 CRI.

# Mechanical Dimensions

**Figure 9: Drawing for Vero 18 LED Array**

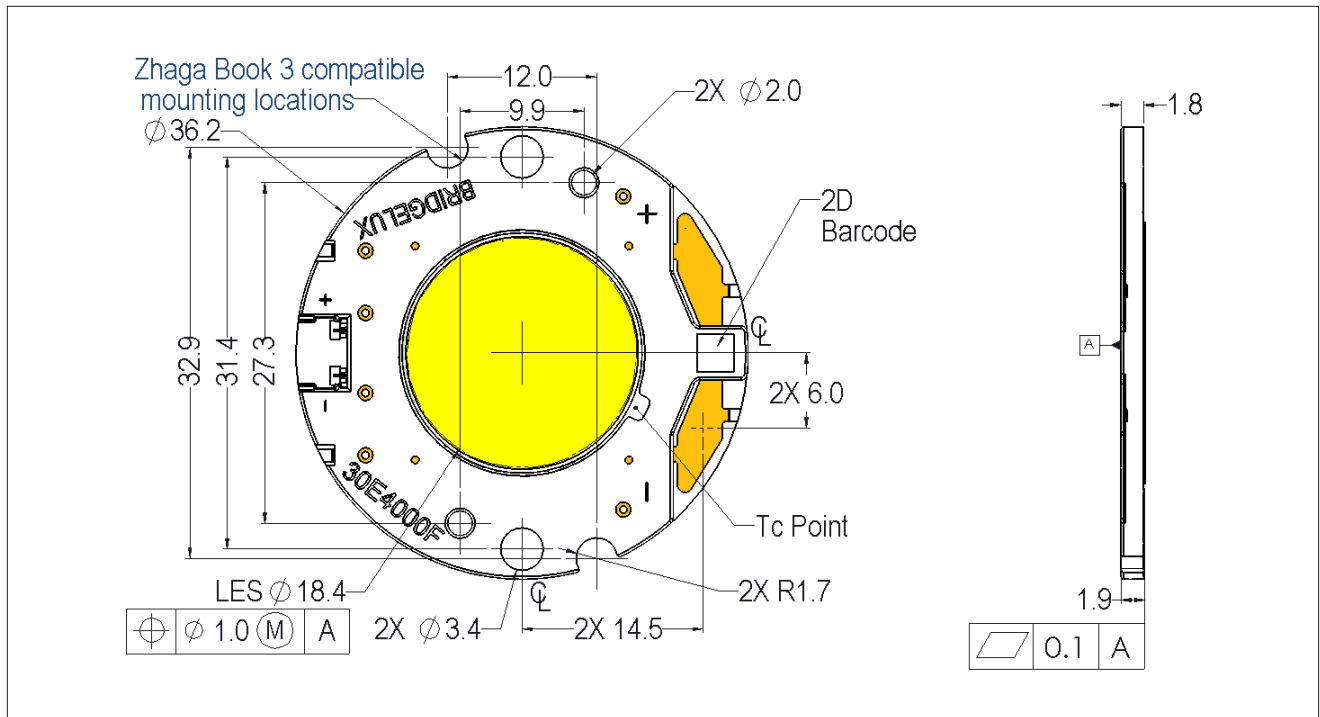

Notes for Figure 9:

1. Drawings are not to scale.
2. Drawing dimensions are in millimeters.
3. Unless otherwise specified, tolerances are  $\pm 0.1\text{mm}$ .
4. Mounting holes (2X) are for M2.5 screws.
5. Bridgelux recommends two tapped holes for mounting screws with  $31.4 \pm 0.10\text{mm}$  center-to-center spacing.
6. Screws with flat shoulders (pan, dome, button, round, truss, mushroom) provide optimal torque control. Do NOT use flat, countersink, or raised head screws.
7. Solder pads and connector port are labeled "+" and "-" to denote positive and negative, respectively.
8. It is not necessary to provide electrical connections to both the solder pads and the connector port. Either set may be used depending on application specific design requirements.
9. Refer to Application Notes AN30 and AN31 for product handling, mounting and heat sink recommendations.
10. The optical center of the LED Array is nominally defined by the mechanical center of the array to a tolerance of  $\pm 0.2\text{mm}$ .
11. Bridgelux maintains a flatness of 0.10mm across the mounting surface of the array.

# Color Binning Information

**Figure 10: Graph of Warm and Neutral White Test Bins in xy Color Space**

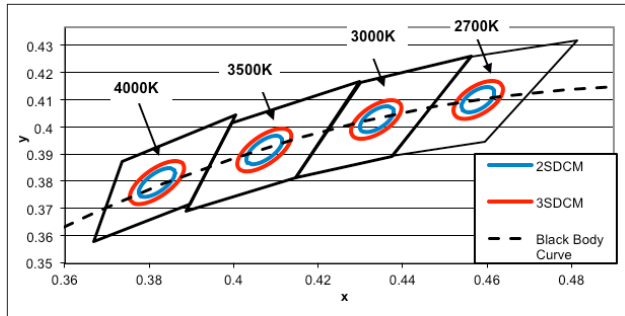

Note: Pulsed Test Conditions,  $T_c = 25^\circ\text{C}$

**Table 6: Warm and Neutral White xy Bin Coordinates and Associated Typical CCT**

Bin Code	2700K	3000K	3500K	4000K
ANSI Bin (for reference only)	(2580K - 2870K)	(2870K - 3220K)	(3220K - 3710K)	(3710K - 4260K)
23 (3SDCM)	(2651K - 2794K)	(2968K - 3136K)	(3369K - 3586K)	(3851K - 4130K)
22 (2SDCM)	(2674K - 2769K)	(2995K - 3107K)	(3404K - 3548K)	(3895K - 4081K)
Center Point (x,y)	(0.4578, 0.4101)	(0.4338, 0.403)	(0.4073, 0.3917)	(0.3818, 0.3797)

**Figure 11: Graph of Cool White Test Bins in xy Color Space**

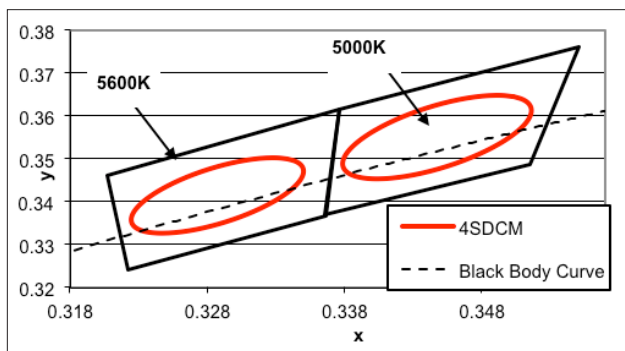

Note: Pulsed Test Conditions,  $T_c = 25^\circ\text{C}$

**Table 7: Cool White xy Bin Coordinates and Associated Typical CCT**

Bin Code	5000K	5600K
ANSI Bin (for reference only)	(4745K - 5311K)	(5310K - 6020K)
24 (4SDCM)	(4801K - 5282K)	(5475K - 5830K)
Center Point (x,y)	(0.3447, 0.3553)	(0.3293, 0.3423)



# Packaging and Labeling

**Figure 12: Drawing for Vero 18 Packaging Tray**

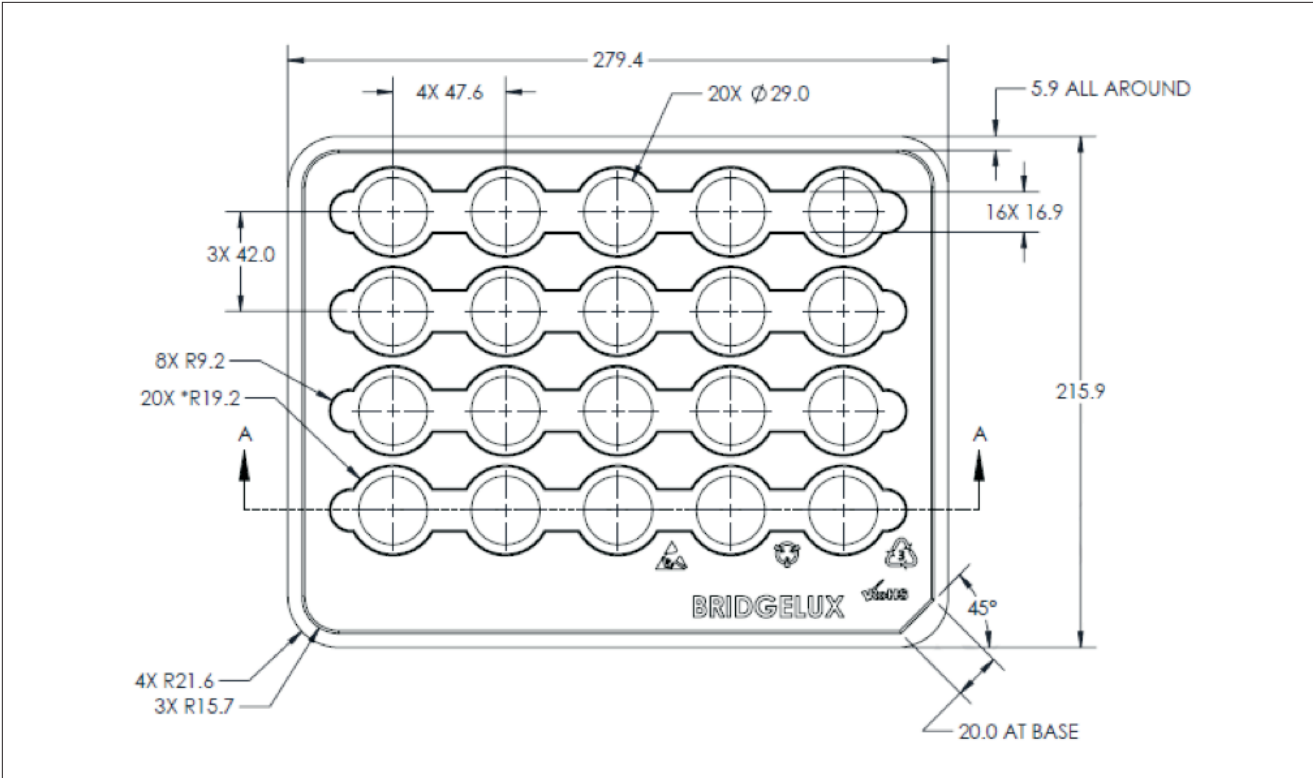

Notes for Figure 12:

1. Dimensions are in millimeters
2. Tolerances: XX - ± 0.1, XXX - ± 0.05, Angles - ±1°
3. Trays are stackable without interference and will not stick together during unstacking operation

# Packaging and Labeling

**Figure 13: Vero Series Packaging and Labeling**

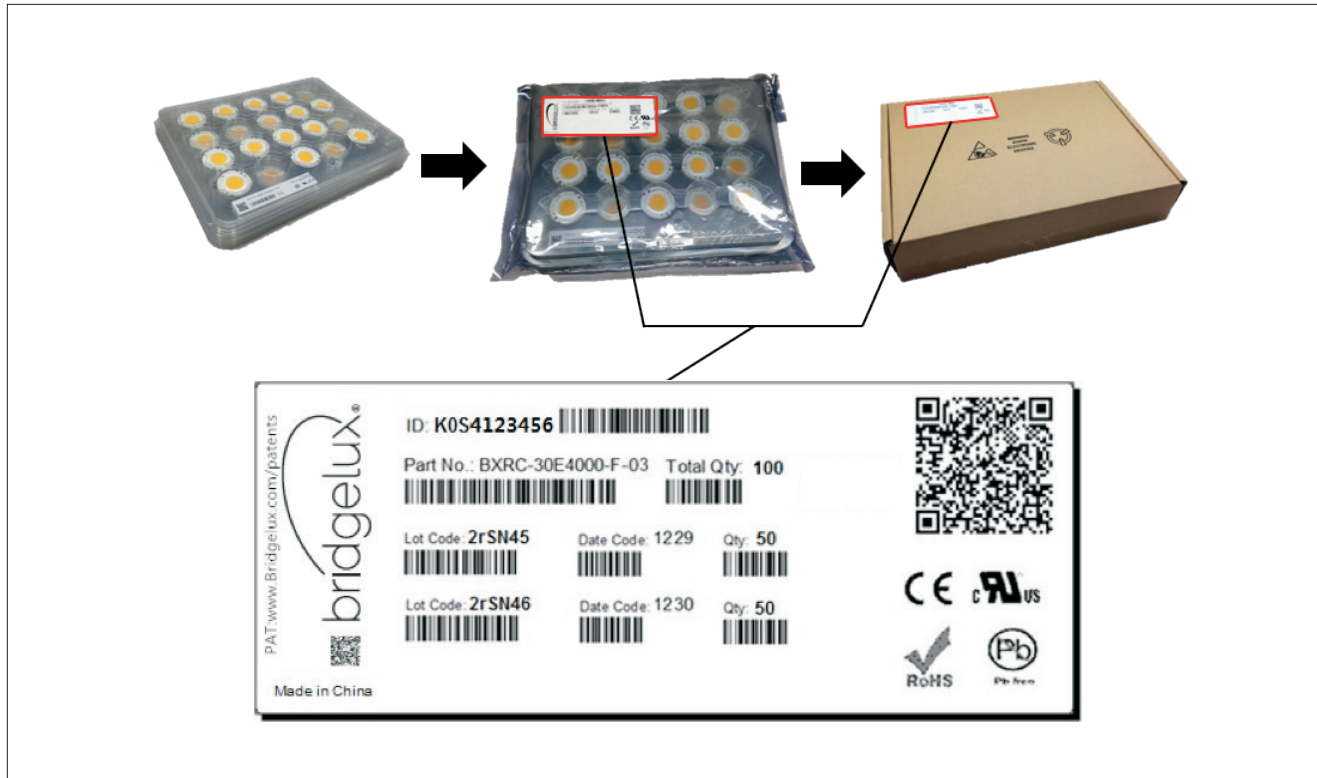

Notes for Figure 13:

1. Each tray holds 20 COBs, 5 trays are stacked and one empty tray placed on top to cover the top tray.
2. Stacked trays are to contain only 1 part number and be vacuum sealed in an anti-static bag and placed in own box.
3. Each bag and box is to be labeled as shown above.

**Figure 14: Product Labeling**

Bridgelux COB arrays have laser markings on the back side of the substrate to help with product identification. In addition to the product identification markings, Bridgelux COB arrays also contain markings for internal Bridgelux manufacturing use only. The image below shows which markings are for customer use and which ones are for Bridgelux internal use only. The Bridgelux internal manufacturing markings are subject to change without notice, however these will not impact the form, function or performance of the COB array.



# Design Resources

## Application Notes

Bridgelux has developed a comprehensive set of application notes and design resources to assist customers in successfully designing with the Vero product family of LED array products. For a list of resources under development, visit [www.bridgelux.com](http://www.bridgelux.com).

## Optical Source Models

Optical source models and ray set files are available for all Bridgelux products. For a list of available formats, visit [www.bridgelux.com](http://www.bridgelux.com).

## 3D CAD Models

Three dimensional CAD models depicting the product outline of all Bridgelux Vero LED arrays are available in both SAT and STEP formats. Please contact your Bridgelux sales representative for assistance.

# Precautions

## CAUTION: CHEMICAL EXPOSURE HAZARD

Exposure to some chemicals commonly used in luminaire manufacturing and assembly can cause damage to the LED array. Please consult Bridgelux Application Note AN31 for additional information.

## CAUTION: EYE SAFETY

Eye safety classification for the use of Bridgelux Vero LED arrays is in accordance with IEC specification EN62471: Photobiological Safety of Lamps and Lamp Systems. Vero LED arrays are classified as Risk Group 1 (Low Risk) when operated at or below the maximum drive current. Please use appropriate precautions. It is important that employees working with LEDs are trained to use them safely.

## CAUTION: RISK OF BURN

Do not touch the Vero LED array or yellow resin area during operation. Allow the array to cool for a sufficient period of time before handling. The Vero LED array may reach elevated temperatures such that could burn skin when touched.

## CAUTION

### CONTACT WITH LIGHT EMITTING SURFACE (LES)

Avoid any contact with the LES. Do not touch the LES of the LED array or apply stress to the LES (yellow phosphor resin area). Contact may cause damage to the LED array.

Optics and reflectors must not be mounted in contact with the LES (yellow phosphor resin area). Optical devices may be mounted on the top surface of the plastic housing of the Vero LED array. Use the mechanical features of the LED array housing, edges and/or mounting holes to locate and secure optical devices as needed.

# Disclaimers

## MINOR PRODUCT CHANGE POLICY

The rigorous qualification testing on products offered by Bridgelux provides performance assurance. Slight cosmetic changes that do not affect form, fit, or function may occur as Bridgelux continues product optimization.

## STANDARD TEST CONDITIONS

Unless otherwise stated, array testing is performed at the nominal drive current.

# About Bridgelux: We Build Light That Transforms

At Bridgelux, we help companies, industries and people experience the power and possibility of light. Since 2002, we've designed LED solutions that are high performing, energy efficient, cost effective and easy to integrate. Our focus is on light's impact on human behavior, delivering products that create better environments, experiences and returns—both experiential and financial. And our patented technology drives new platforms for commercial and industrial luminaires.

**For more information about the company, please visit**  
**bridgelux.com**  
**twitter.com/Bridgelux**  
**facebook.com/Bridgelux**  
**WeChat ID: BridgeluxInChina**



101 Portola Avenue  
Livermore, CA 94551  
Tel (925) 583-8400  
Fax (925) 583-8410  
**www.bridgelux.com**

© 2015 Bridgelux, Inc. All rights reserved 2015. Product specifications are subject to change without notice. Bridgelux, the Bridgelux stylized logo design and Vero are registered trademarks, and Decor Series is a trademark of Bridgelux, Inc. All other trademarks are the property of their respective owners.

Bridgelux Vero 18 Array Series Product Data Sheet DS32 Rev. H (09/2015)